

As a fiber-optic probe that can be used for a wide range of applications, the LED 25 is a genuine innovation in the field of light measurement. For the first time ever, it is now possible to measure averaged LED intensity (I_{LED-A} and I_{LED-B}), illuminance and (using a goniometer) luminous flux with a single measurement head. At the same time, only a single calibration is required.

WE BRING QUALITY TO LIGHT

**APPLICATION
NOTE**

LED 25

Fiber-optic Probe for Averaged LED Intensity

LED 25 as a fiber-optic probe for I_{LED-A} and I_{LED-B} measurements

Single LEDs for the visible spectral range are typically described in terms of the following photometric quantities: luminous intensity I_v , luminous flux Φ_v , and the dominant wavelength. In the case of white LEDs, the "correlated color temperature" (CCT; unit: Kelvin) is usually stated. Since the luminous intensity is defined by the derivate $d\Phi/d\Omega$, the surface area of the detector should be as small as possible and the distance between the tip of the LED and the detector as large as possible. In general,

such conditions can be set up only on a laboratory scale. For this reason, CIE publication 127 introduced the optical quantity of 'averaged LED intensity' (I_{LED-A} or I_{LED-B}) for measuring single LEDs in 1997. According to this recommendation, a locally homogeneous detector with a surface area of 100 mm² and $V(\lambda)$ -shaped spectral response should be positioned 316 mm or 100 mm (for I_{LED-A} and I_{LED-B} respectively) away from the tip of the LED to be measured.

Fig. 1a: Measurement geometry for I_{LED-A} and I_{LED-B}

Fig. 1b: LED 25 in combination with an I_{LED-B} spacer tube and an LED mounted in a test socket

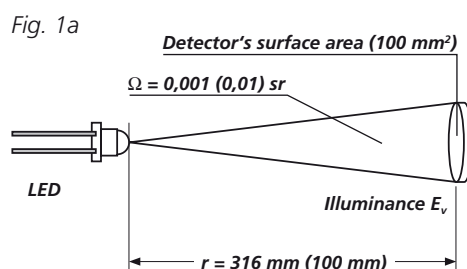
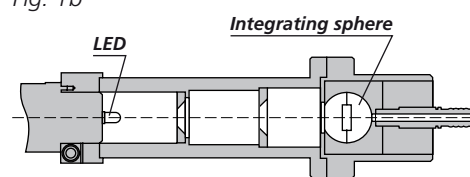

Fig. 1b



Since in most cases the tip of an LED does not correspond to the LED's point of light emission, I_{LED-A} and I_{LED-B} represent independent measurement quantities that are defined by the average illuminance at a specific distance from the respective light source multiplied by the square of this distance.

$$I_{LED-A, B} = E_v \cdot r^2_{A, B}$$

Fig. 1a shows the basic measurement geometry, Fig. 1b a sectional drawing of the LED 25 in combination with an I_{LED-B} spacer tube and an LED in a test fixture.

Although $I_{\text{LED-A}}$ and $I_{\text{LED-B}}$ cannot be compared directly with luminous intensity, the requirements regarding measurement geometry and detector specifications are nevertheless comparable: The spectral and absolute responsivity of the detector must be homogeneous over the entire area. Particularly in the case of high-brightness LEDs, which usually have a narrow-angled radiation pattern, this is crucial because the irradiance along the detector area can vary significantly. Detectors with poor homogeneity lead to slightly inconsistent results, which makes it far more difficult to compare them. To keep uncertainties in measurement as small as possible, the angular characteristic of the detector must also demonstrate a certain quality, especially when expanded light sources or clusters are to be examined. When

connected to a spectroradiometer by means of a fiber bundle, the LED 25 probe meets all of these requirements. Fig. 2 (left) plots the photometric response against the cross-section of the detector. On the right is the corresponding angular characteristic, which in the case of an ideal detector is perfectly circular (cosine response). Fig. 3 plots chromaticity coordinates (x , y) of a black-body radiator (halogen lamp) against the lateral position (left) and the angle of incidence (right). The respective variation of x and y from the nominal value is always less than 0.001. As a modular system, the LED 25 can be used with spacers for $I_{\text{LED-A}}$ and $I_{\text{LED-B}}$. When used in conjunction with a spectroradiometer, it is possible to take photometric and radiometric measurements within a spectral range of 220 to 2500 nm.

Fig. 2: Lateral light throughput of the LED 25 along the cross-section (left) and as a function of the angle of incidence (right)

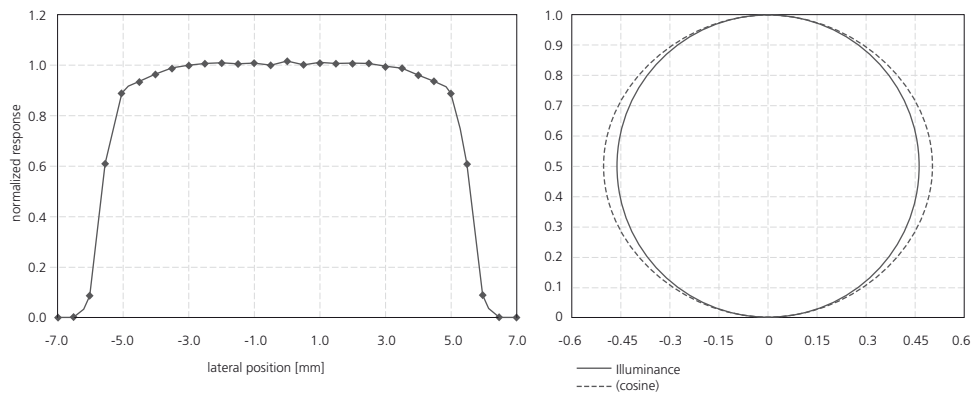
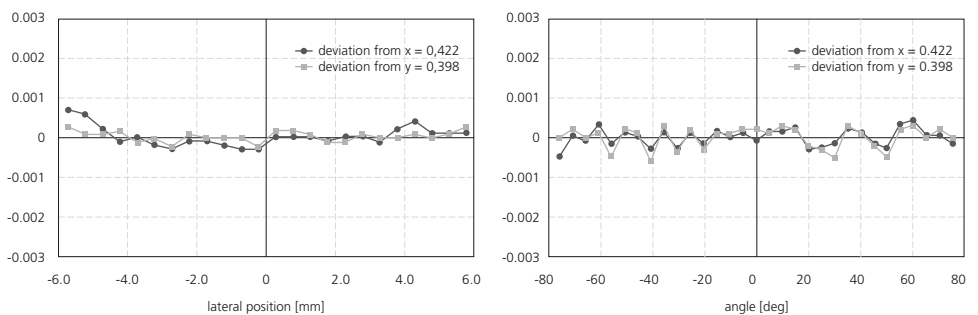

Fig. 3: Deviation of the chromaticity coordinates (x , y) of a halogen lamp as a function of the lateral position (left) and the angle of incidence (right)



LED 25 as a fiber-optic probe for measuring irradiance and illuminance

Thanks to its good cosine characteristic already mentioned above, the LED 25 is also perfect for use as a universal fiber-optic probe for measuring the irradiance and illuminance of light sources of practically any geometry. It is calibrated both spectrally and absolutely with the aid of broadband light sources (halogen or deuterium lamps). A potential measurement geometry for LED modules is depicted in Fig. 4. Note that as the distance (r) becomes smaller, the maxi-

mum angle of incidence on the LED 25 becomes larger and larger. The variations of the response from the ideal cosinusoidal curve as shown in Fig. 2 then become increasingly important and affect the uncertainty in measurement. Fig. 5 plots the systematic variation against the aspect ratio ($v = D/2r$), where D is the diameter of the module. If this value is 1/2, for example, the distance r between the LED 25 probe and the LED module corresponds to its

Fig. 4: Potential measurement geometry for testing LED modules

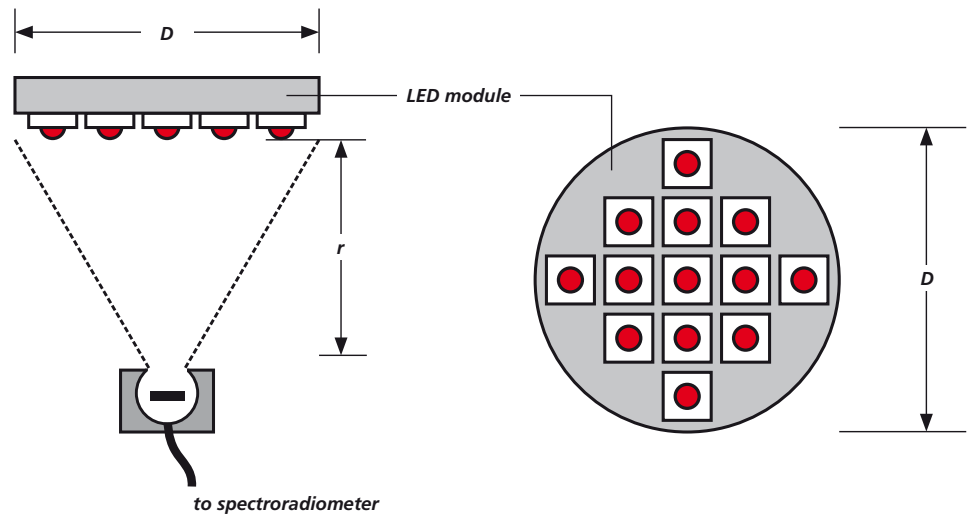

diameter. In this case, the percentage variation amounts to just 2%. In the event of even smaller distances or higher requirements regarding measurement

uncertainty, it is possible to use cosine-optimized fiber-optic probes, such as the ISP 40.

LED 25 as a fiber-optic probe for goniometric measurement of luminous flux using a spectroradiometer

In this application, the LED 25 is used as a fiber-optic probe in conjunction with the LEDGON goniometer and a spectroradiometer. As in the first application, calibration is conducted based on irradiance with the aid of a radiometric standard (halogen or deuterium lamp). The LED 25 is then positioned at a specified distance from the light source to be investigated. Fig. 7 shows a schematic diagram of a configuration typically used for measuring small LED modules. This configuration makes it

possible to plot the radiation pattern at different distances. Some LED modules that are used in traffic signals often have a batwing type of radiation pattern in which the major emission is deliberately suppressed at 0° . Fig. 6 shows an example of such a module (left); on the right are the radiation patterns in the near field and the far field ($r = 100$ mm and $r = 500$ mm respectively), plotted using the LED 25 probe and LEDGON goniophotometer.

Fig. 5: Percentage variation of the measured illuminance from the actual value as a function of the aperture ratio for light sources that take the form of a circular area (e.g. certain LED modules)

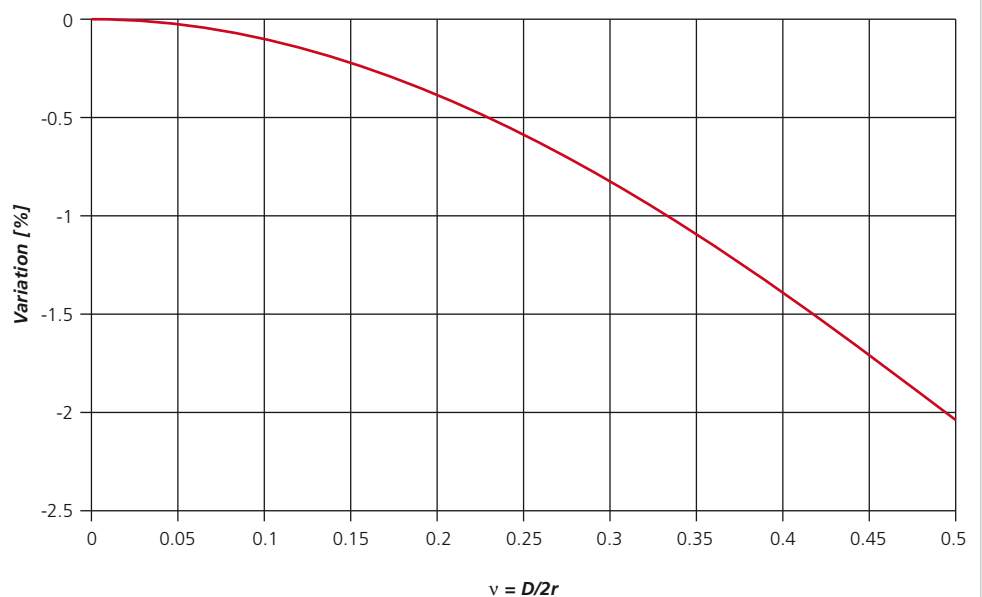



**Fig. 6: Top: LED module as is used in traffic light systems
Right: Examples of radiation patterns in the near field (top diagram) and the far field (bottom diagram)**

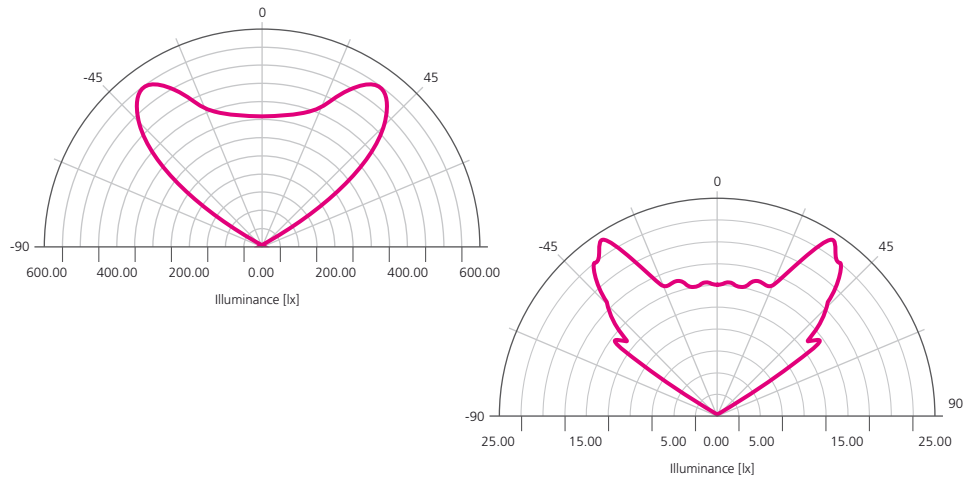
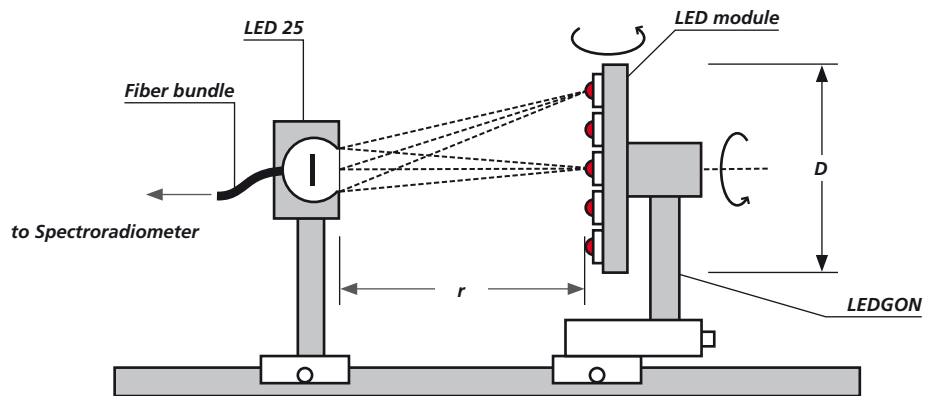

Fig. 7: Schematic drawing illustrating luminous flux measurement using the LED 25 and LEDGON



For correct luminous flux measurement, it must be ensured that the angle scan of the LEDGON covers all directions in which light is emitted. The luminous flux is calculated from integration of the radiation pattern over the measured solid angle:

$$\Phi_v = \int_{(F)} E_v dA = \int_{(F)} E_v r^2 d\Omega = \int_{-\pi/2}^{\pi/2} \int_0^{2\pi} E_v(\theta, \varphi) r^2 \sin\theta d\theta d\varphi$$

Furthermore, the good cosine response of the LED 25 makes it possible to determine the luminous flux by means of near field measurements. Such an

arrangement has the advantage of an improved light signal at the detector and associated short measurement times. The systematic errors resulting from the variation from the ideal cosinusoidal response are – in the case of the module under consideration and with a diameter (D) of 50 mm – below 1% if one compares the far and near fields (r = 500 mm and 100 mm respectively). Greater variations arise only in the event of aspect ratios where $v = D/2r > 0.35$.

Instrument Systems GmbH
Kastenbauerstr. 2
D-81677 Munich, Germany
Tel.: +49 89 454943-0
Fax: +49 89 454943-11
info@instrumentsystems.de
www.instrumentsystems.de