



KONICA MINOLTA

# 2D Color Analyzer CA-2500

**Ideal for display mura (nonuniformity) evaluation and inspection on smartphones and tablet PCs.**

**Accurately and easily measures the distribution of luminance and chromaticity.**

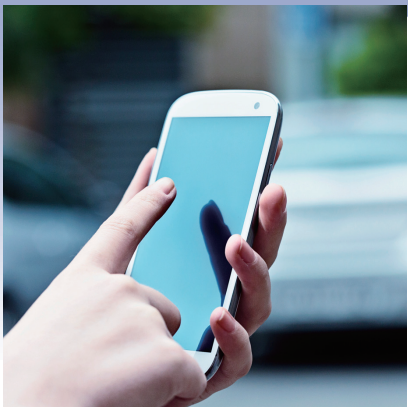

# ■ 2D Color Analyzer CA-2500

## XYZ filters provide high correlation with the spectral response of the human eye.

Instead of the RGB color-separation filters used by digital video cameras, etc., the CA-2500 uses XYZ filters that closely match the CIE 1931 color-matching functions to provide luminance and chromaticity measurements that have high correlation with the spectral response of the human eye.

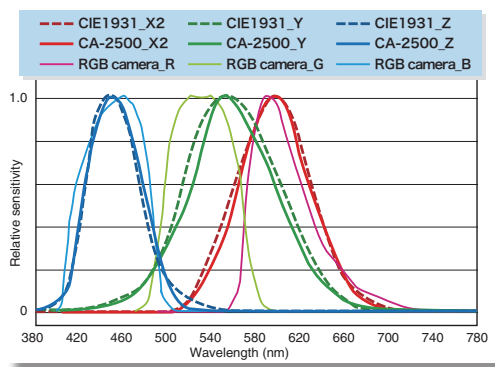

## Interchangeable lenses for measurements of various subjects

Standard, wide-angle, and telephoto lenses (plus two macro rings for the telephoto lens) are available, enabling the optimum lens to be selected according to the particular subject, measurement area, or measurement method.

## Comprehensive factory calibration

Each lens is individually factory-calibrated at multiple focal points to correct for sensitivity variations due to the combination of sensor, optical filters, and the lens itself. By using the included calibration data, high-accuracy measurements of luminance and chromaticity distribution can be taken immediately after receiving the product without being restricted to a particular measurement method, subject size or subject brightness.

## Even flickering light sources such as OLED televisions or PDP can be measured with good accuracy.

The synchronization frequency (4 to 2,000 Hz) of display devices and pulsed light sources can be input to enable synchronized measurements.

## Expanded low-luminance measurement range

The minimum measurable luminance has been improved from 0.1 cd/m<sup>2</sup> to 0.05 cd/m<sup>2</sup>.

## Improved durability

Service life measurement cycles have been increased to approximately 5 times that of the CA-2000.



The small, lightweight body lets the CA-2500 be used in a wide variety of fields, such as display, illumination, automotive, aviation, and other industries.

### Includes advanced Data Management Software CA-S25w as standard accessory

Advanced functions such as focus assist, positioning assist, and automatic measurement area extraction greatly simplify troublesome measurement preparations and data evaluation.

### Includes SDK (software development kit)

The SDK can be used by customers to efficiently create their own software for controlling the CA-2500. SDK for Labview® also available.

### Optional Mura Evaluation Software

This optional software uses an exclusive algorithm to enable mura (unevenness) evaluation that more closely correlates with visual evaluation. (Details on later page.)

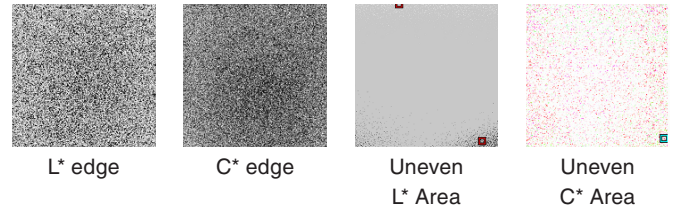

### Applications

- Simultaneous luminance/ chromaticity distribution measurement of multiple small- or medium-sized LCD or organic EL panels
- Luminance/chromaticity measurement of single large-sized LCD or organic EL panels
- Display mura (unevenness) evaluation
- Luminance distribution measurements in illumination field
- Measurements of luminance/ correlated color temperature distribution of various light-emitting subjects
- Luminance distribution measurements of automobile instrument panel meters
- Measurement of distribution of luminance and chromaticity on screen image from projectors



### Dimensions (Unit: mm) \*When standard lens and lens hood are attached

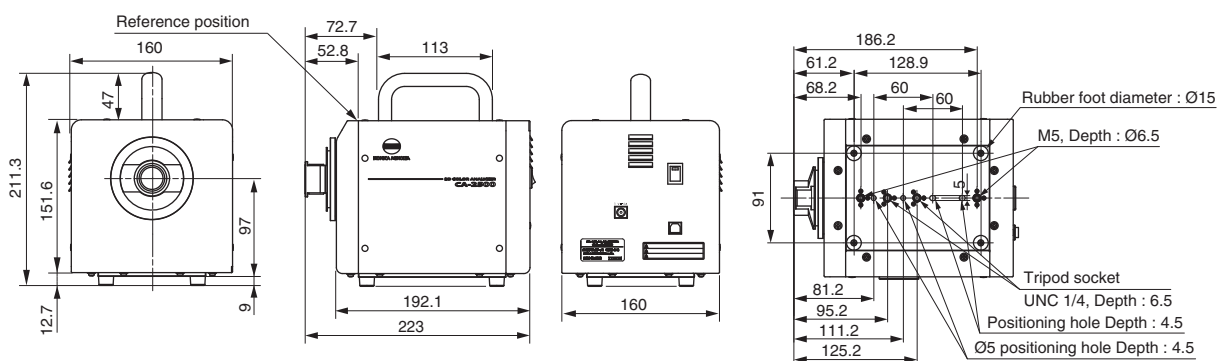

# ■ Data Management Software CA-S25w

The included software provides advanced functionality with simple operation to make the entire measurement process easier, from measurement preparations such as focusing and positioning through measurements of luminance and chromaticity distribution to evaluation of measurement results.

## GUI assists with normal workflow

Measurement preparation screen

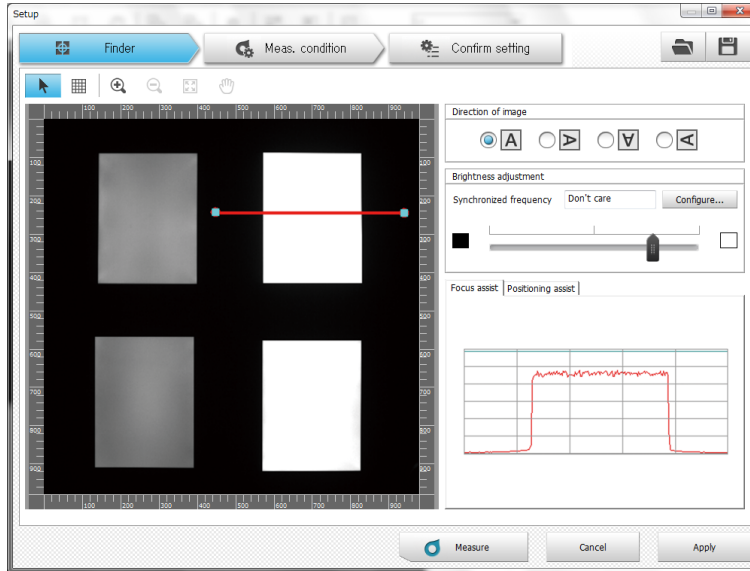

## Easy-to-understand screens with easy-to-use tools

Measurement results screen

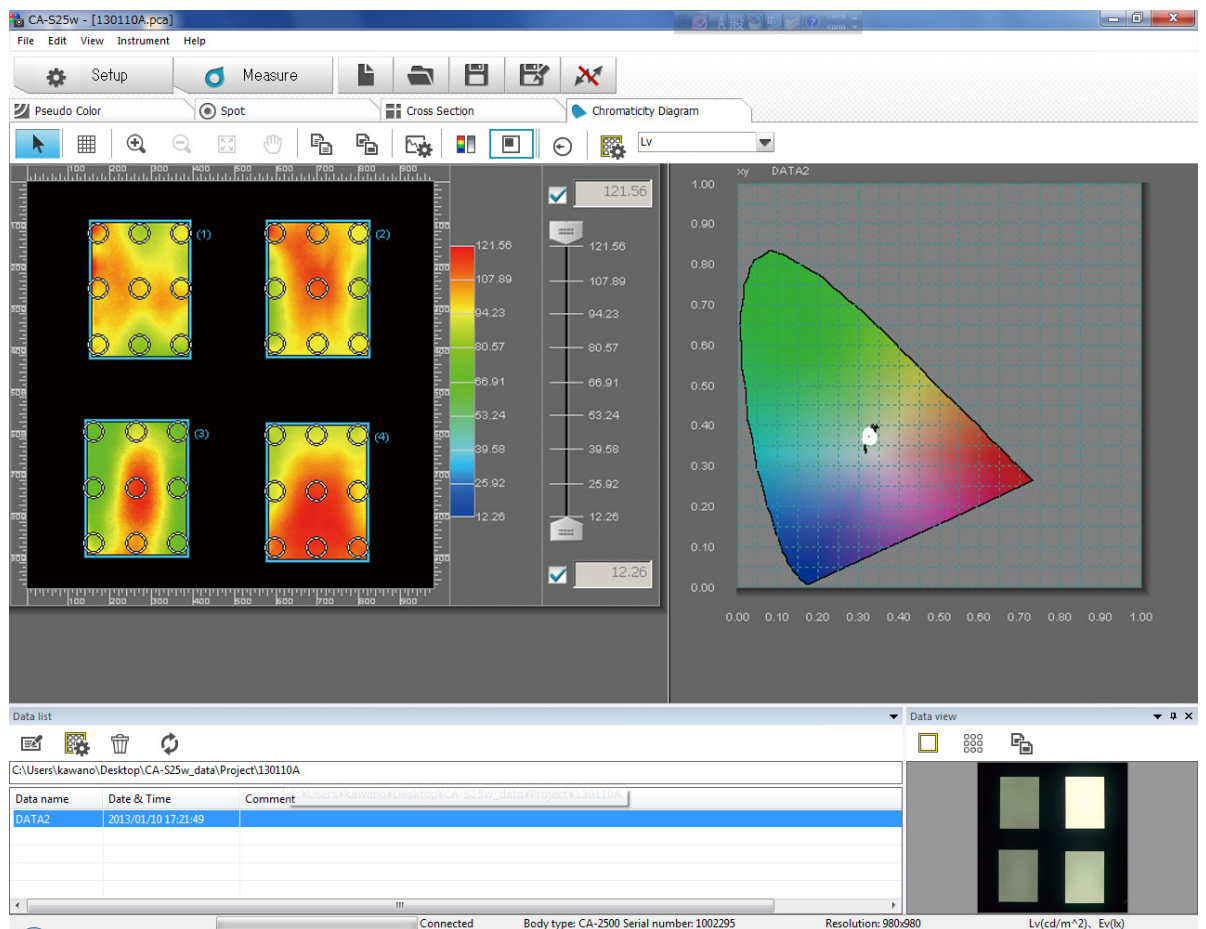



CA-S25w can also read data measured and saved with the previous software CA-S20w. Visit our website to download the latest CA-S25w free of charge.

### Focus assist function

Focus adjustment can be performed easily by viewing the cross-sectional slope of the luminance at the border between bright and dark areas.



When subject is not in focus

When subject is in focus

### Positioning assist function

The positioning and orientation (tilt and twist) of the CA-2500 relative to the measurement subject can be easily checked while making fine adjustments, reducing the work and time required to achieve proper positioning and orientation.

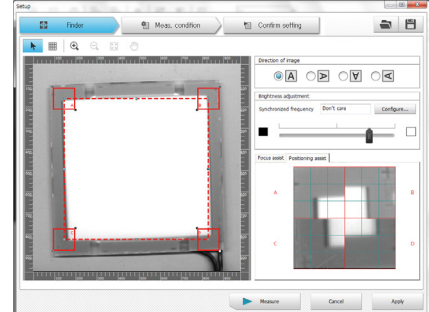

### Automatic measurement area extraction function

The light-emitting areas of measurement subjects can be automatically extracted and set as evaluation regions. This eliminates the need for manually defining and positioning evaluation regions, reducing the setup time required.

### Various data evaluation screens

#### Pseudocolor display

Luminance and chromaticity distribution can be easily observed.

#### Spot measurement

The size and number of spots to be evaluated (indicated by black circles in the screen example above) can be freely defined by the user to enable multi-point measurement using the average values of each spot. Up to a maximum of 2500 spots can be defined.

#### Chromaticity diagram display

Variations in chromaticity can be displayed on the chromaticity diagram display.

### Multi-subject measurement capability

Evaluation of the mura (unevenness) of multiple subjects can now be performed simultaneously. With the previous CA-S20w, the same tone gradation scale was used for all subjects; if subject luminances were very different, adjusting the scale to properly view one subject caused saturation of tones in evaluation areas for other subjects. But with CA-S25w, each evaluation area has its own tone gradation scale which can be individually adjusted according to the subject luminance. This allows the mura of multiple subjects with widely different luminances to be viewed simultaneously on the same screen.

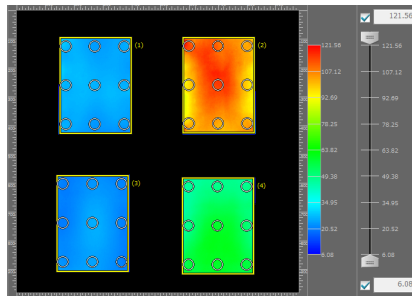

With single-scale setting of previous software

### Other convenient functions

#### Data transfer to Excel®, etc.

The desired range of data or spot values can be selected and transferred to Excel®, Word®, etc. via the clipboard. The various graphs and displays can also be copied and pasted, making it easy to create reports.

#### Multiple exposure function

By combining measurement data obtained using exposure times optimized for different luminance levels, subjects requiring a wide dynamic range (such as a gray scale) can be easily measured.

#### CSV file import

Measurement data can be stored in CSV format. The stored CSV-format data can then be imported and displayed in pseudocolor graphs, etc.

#### User color gamut calibration

User calibration can be performed for each color gamut of the measurement subject, improving chromaticity measurement accuracy when measuring subjects that use multiple colors, such as automobile instrument panels that use LEDs of various colors.

# Mura Evaluation Software CA-Mura (Optional accessory)

Optional add-in software for Data Management Software CA-S25w

## Quantification of luminance and chromaticity mura (unevenness) of various types of displays using 3 original index values: Luminance evaluation value, Color evaluation value, and Generic mura evaluation value

In the past, it has been difficult to quantitatively define the degree of mura of displays. Mura Evaluation Software CA-Mura processes the measurement data from the 2D Color Analyzer CA-2500 to provide mura values that closely correlate with the degree of mura determined by visual evaluation. The closer these values are to zero, the less mura exhibited by the display.

### Mura Evaluation Software CA-Mura system requirements

In addition to the system requirements for Data Management Software CA-S25w (Windows® 11 is not supported)

<Compatible instruments>  
CA-2500 controlled by CA-S25w

<Display language>  
English, Simplified Chinese, or Japanese (Selectable at time of installation)

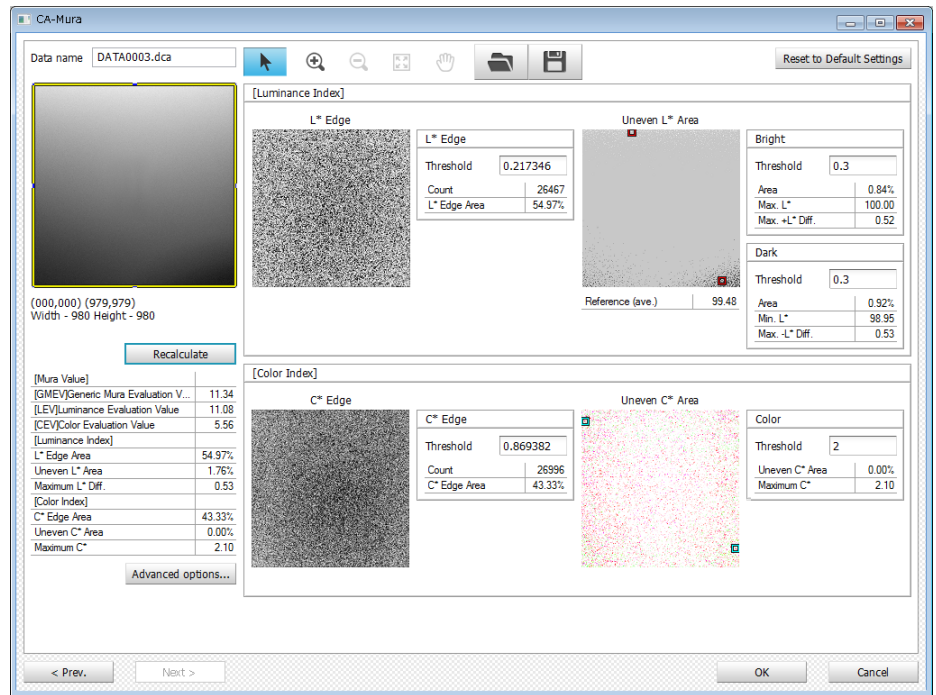

CA-Mura display example

## CA-Mura evaluation

Shown below are the CA-Mura evaluation data for three kinds of displays with different degrees of mura measured using the 2D Color Analyzer CA-2500. \*Sample display images are examples only.

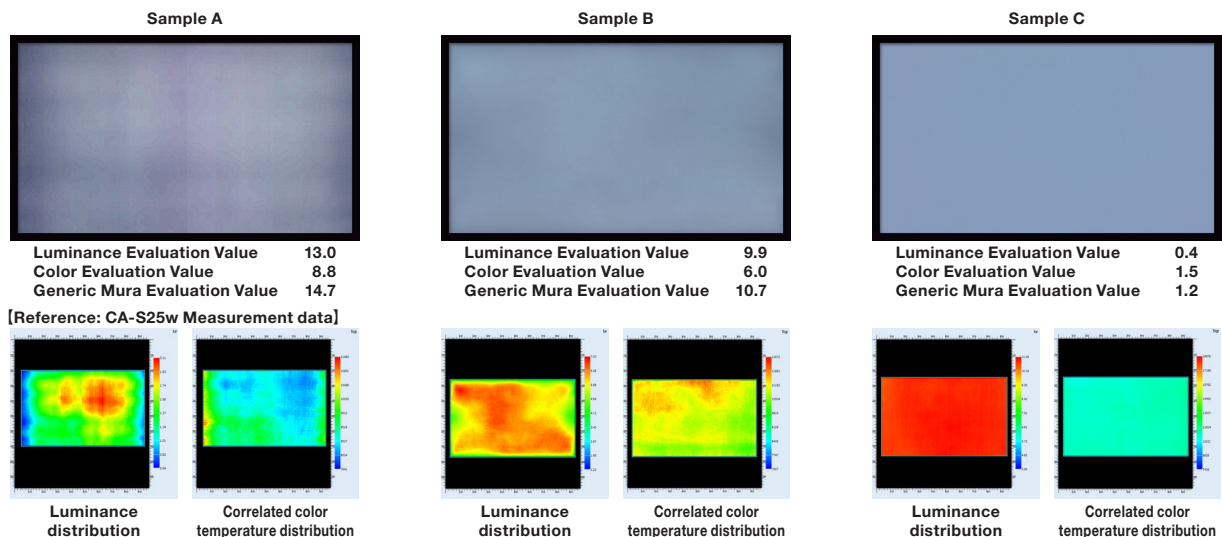

## Algorithm

CA-Mura determines the luminance distribution and chromaticity distribution from the XYZ data measured by the 2D Color Analyzer, and applies the spatial characteristics of human vision.

These data are then converted to the L\*a\*b\* color space, and after edge and light/dark processing (for luminance mura) and high-chromaticity processing (for chromaticity mura), the Luminance evaluation value (LEV), Color evaluation value (CEV), and the Generic mura evaluation value (GMEV) based on LEV and CEV are calculated.

Determination of these values is performed using the mura quantitative evaluation method developed by Sony Corporation.

# Additional information on the 2D Color Analyzer CA-2500 system and accessories

## System Diagram

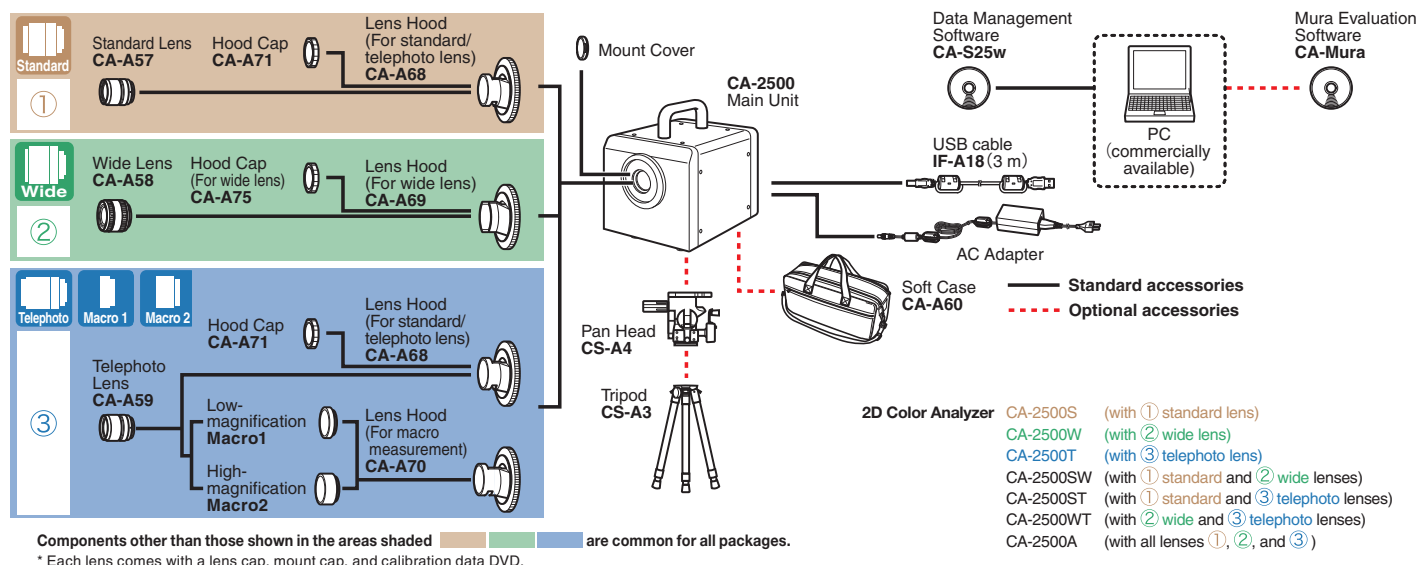

## Measurable object size with typical measurement distances (Width/height of measurement square)

Distance (mm)	Standard lens			Wide lens			Telephoto lens			Low magnification macro ring			High magnification macro ring		
	Measurement size (mm)	Measurable display size (inches)		Measurement size (mm)	Measurable display size (inches)		Measurement size (mm)	Measurable display size (inches)		Measurement size (mm)	Measurable display size (inches)		Measurement size (mm)	Measurable display size (inches)	
		16 : 9	4 : 3		16 : 9	4 : 3		16 : 9	4 : 3		16 : 9	4 : 3		16 : 9	4 : 3
250	98	4.4	4.8	190	8.6	9.3									
300	121	5.5	6	235	11	12							27	1.2	1.3
500	212	9.6	10.4	416	19	20				57	2.5	2.8			
1,000	439	20	22	869	39	43	130	5.9	6.4						
2,000	892	40	44	1,776	80	87	275	12	14						
3,000	1,345	61	66	2,682	121	132	420	19	21						
5,000	2,252	102	111	4,495	203	221	711	32	35						

## Data Management Software CA-S25w

### System Requirements

- OS** Windows® 10 Pro 32-bit, 64-bit  
Windows® 11 Pro  
(English, Simplified Chinese, or Japanese)
- The hardware of the computer system to be used must meet or exceed the greater of the recommended system requirements for the compatible OS being used or the following specifications.
- CPU** Pentium® 4 2.8 GHz equivalent or higher
- Memory** 1,024 MB or more
- Hard Disk** Needs free space of at least 80 MB on system drive (where OS is installed)  
In addition, each lens needs the following free spaces for installing calibration data.  
For standard lens: approx. 540 MB  
For wide lens: approx. 470 MB  
For telephoto lens: approx. 1.3 GB  
To save measurement data on hard disk, additional free space is required (approx. 110 MB for 10 measurement data)  
Approx. 1 MB required for setting files containing spot settings, measurement condition settings, etc.
- Display** Display capable of at least 1,280 x 768 dots / 65,536 colors (High color, 16-bit)
- Others** Optical drive capable of reading CD-ROM (for installing software) and DVD-ROM (for installing calibration data) necessary.  
USB port: For connecting measuring instrument
- Controllable instruments** : CA-2500
- Display language** : English, Simplified Chinese, or Japanese (Selectable at time of installation)

# Main Specifications CA-2500

Model	CA-2500S	CA-2500W	CA-2500T				
Receptor	CCD image sensor (monochrome); 2/3-inch; Effective number of pixels: 1,000 x 1,000 pixels; Equipped with XYZ filter (closely matches CIE 1931 color-matching function) and ND filter						
Lens	Interchangeable Standard, wide, and telephoto lenses; low-magnification and high-magnification macro rings (for use with telephoto lens)						
Measurement points (Resolution)	980 x 980 (490 x 490 or 196 x 196 selectable by using Data Management Software CA-S25w)						
Color indication modes	XYZ, L <sub>v</sub> x <sub>y</sub> , L <sub>v</sub> u'v', TΔuv, Dominant wavelength, Excitation purity, L <sub>v</sub> contrast						
Display modes	Pseudocolor, Chromaticity diagram, Spot, Cross section, Color difference						
Measurement sizes (length per side of square) (*1)	Standard lens		Wide lens		Telephoto lens		
	Approx. 98 mm or more (depending on the distance)		Approx. 145 mm or more (depending on the distance)		Approx. 115 mm or more (depending on the distance)		
Measurable size for typical measurement distances (size/distance)	98 mm / 250 mm		145 mm / 200 mm		115 mm / 900 mm		
	210 mm / 500 mm		410 mm / 500 mm		275 mm / 2,000 mm		
	440 mm / 1,000 mm		850 mm / 1,000 mm		420 mm / 3,000 mm		
	890 mm / 2,000 mm		1,770 mm / 2,000 mm				
Measurement luminance range (including ND filter use)	0.05 - 100,000 cd/m <sup>2</sup>		0.05 - 100,000 cd/m <sup>2</sup>		0.25 - 100,000 cd/m <sup>2</sup>		
Measurement time (*2)	Single : Approx. 5 sec. or more; 4-time integration: Approx. 6 sec. or more; 16-time integration: Approx. 10 sec. or more; 64-time integration : Approx. 25 sec. or more; 256-time integration : Approx. 80 sec. or more						
Accuracy (*3)	Luminance	±3 %		±3 %		±3 %	
	Chromaticity	±0.005		±0.005		±0.005	
Repeatability (*4)	Luminance	0.5 %		0.5 %		0.5 %	
	Chromaticity	0.001		0.001		0.001	
Inter-point error (*5)	Luminance (*6)	±2 %		±2 %		±2 %	
	Chromaticity (*6)	±0.002		±0.002		±0.002	
	Luminance (*7)	±3 %		±3 %		±3 %	
	Chromaticity (*7)	±0.003		±0.003		±0.003	
Other functions	Measurement sync (Synchronization frequency selectable), User calibration, Integration function						
Interface	USB 2.0 or higher						
Operation temperature / humidity range (*8)	10-30°C, Relative humidity 70% or less/No condensation						
Storage temperature / humidity range (*8)	0-30°C, Relative humidity 70% or less/No condensation, 30-35°C, Relative humidity 55% or less/No condensation						
Size	Body only	160 (W) x 164 (H) x 192 (D) mm (Height including handle: 211 mm)					
	When lens and lens hood are attached	223 (D) mm	219 (D) mm	224 (D) mm	230 (D) mm	237 (D) mm	
Weight	3.5 kg approx. (when standard lens and lens hood are attached)						
Power	AC Adapter						

- \*1: Error in angle of view: 7%
- \*2: Measurement time differs depending on brightness of measurement object, PC performance, and data processing contents.  
The specifications above were obtained under Konica Minolta's measurement conditions shown below:  
PC CPU : Intel Core i7-3770 3.40GHz  
Memory : 8GB  
Data processing : Pseudocolor display of luminance data  
Resolution : 980 x 980  
Shutter speed : Y measurement : 1/64 sec., XZ measurement : 1/32 sec.  
Measurement subject brightness:  
Standard/wide lens: Approx. 80 cd/m<sup>2</sup>, Telephoto lens: Approx. 300 cd/m<sup>2</sup>  
Low-magnification macro ring and telephoto lens: Approx. 400 cd/m<sup>2</sup>,  
High-magnification macro ring and telephoto lens: Approx. 600 cd/m<sup>2</sup>
- \* The measurement time becomes longer when the object is dark. The longest measurement time is approx. 14 seconds with 1-time integration, approx. 45 seconds with 4-time integration, approx. 3 minutes with 16-time integration, approx. 11 minutes with 64-time integration and approx. 44 minutes with 256-time integration
- \*3: The specifications above were obtained under Konica Minolta's measurement conditions shown below:  
Measurement subject brightness:  
Standard/wide lens: Approx. 35 cd/m<sup>2</sup>, Telephoto lens: Approx. 140 cd/m<sup>2</sup>  
Low-magnification macro ring and telephoto lens: Approx. 250 cd/m<sup>2</sup>,  
High-magnification macro ring and telephoto lens: Approx. 250 cd/m<sup>2</sup>
- Distance: Minimum distance of each lens, Evaluation: Based on the average obtained within 10% range at the center of the screen, Temperature: 23°C±2°C, Relative humidity: 40%±10%, Measuring light: White, reference light source, Integration: 64 times (Normal mode)
- \*4: The specifications above were obtained under Konica Minolta's measurement conditions shown below:  
Resolution: 196 x 196, Shutter speed: Y measurement: 1/64 sec., XZ measurement: 1/32 sec. Gain: Normal (x1), Light intensity level: Midpoint of appropriate light intensity range, Evaluation: Based on the maximum repeatability (2σ) of all pixels, Temperature: 23°C±2°C, Relative humidity: 40%±10%, Measurement subject: White, reference light source, Integration: 64 times (Normal mode)
- \*5: The specifications above were obtained under Konica Minolta's measurement conditions shown below:  
Measurement subject brightness:  
Standard/wide lens: Approx. 40 cd/m<sup>2</sup>, Telephoto lens: Approx. 160 cd/m<sup>2</sup>  
Low-magnification macro ring and telephoto lens: Approx. 200 cd/m<sup>2</sup>,  
High-magnification macro ring and telephoto lens: Approx. 350 cd/m<sup>2</sup>
- Distance: Calibration distance of each lens, Resolution: 196 x 196  
Evaluation (\*6) : Based on the maximum/minimum values obtained in a square at the center of the screen measuring 60% of the height and width of the entire screen  
(\*7) : Based on the maximum/minimum values obtained in the entire screen  
Temperature: 23°C±2°C, Relative humidity: 40%±10%, Measurement subject: White, reference light source, Integration: 64 times (Normal mode)
- \*8: Even if the instrument is stored within the specified usage (or storage) temperature humidity range, the displayed value may change depending on long-period usage or storage conditions.

## Cautions Regarding Temperature / Humidity Conditions for CA-2500

It is recommended that the instrument be used and stored under standard conditions (Temperature: 23° C; Relative humidity: 40 %), and that areas subject to high temperature and/or humidity be avoided. In addition, in order to maintain the measurement accuracy or this instrument, it is recommended that it be inspected regularly about once a year. For details on having the instrument inspected, please contact the nearest Konica Minolta authorized service facility.  
Even if the product is used within the specified operating temperature/humidity range or stored within the specified storage temperature/humidity range, the displayed values may be affected by long-term conditions of use or storage.

If the instrument is left under the following high-temperature conditions for a long period of time, the displayed values may change as follows:

Temperature: 30° C; Relative humidity: 70 %; Period under these conditions: 720 hours (30 days)

Accuracy: Luminance: ±0.4%; Chromaticity: ±0.003

Inter-point error: Luminance: ±0.2 %; Chromaticity: ±0.0003

Temperature: 35° C; Relative humidity: 55 %; Period under these conditions: 336 hours (14 days)

Accuracy: Luminance: ±1%; Chromaticity: ±0.006

Inter-point error: Luminance: ±0.5 %; Chromaticity: ±0.001

These differences in display values are due to the instrument materials and/or components being affected by the temperature and humidity conditions of long-term use or storage. In particular, optical filters are easily affected by temperature or humidity. Although measures have been taken to improve resistance to temperature/humidity changes, the accumulated effect of long-term use or storage may affect the displayed values.

- KONICA MINOLTA, the Konica Minolta logo and symbol mark, and "Giving Shape to ideas" are registered trademarks or trademarks of KONICA MINOLTA, INC.
- Other company names and product names used herein are trademarks or registered trademarks of the respective companies
- The specifications and appearance shown herein are subject to change without notice.
- Some lamp control methods may make accurate measurements difficult.
- For details, please contact your nearest Konica Minolta sales office or dealer.
- If you have any questions about specifications, please contact your Konica Minolta representative.

**SAFETY PRECAUTIONS**



For correct use and for your safety, be sure to read the instruction manual before using the instrument.

- Always connect the instrument to the specified power supply voltage. Improper connection may cause a fire or electric shock.

ISO Certifications of KONICA MINOLTA, Inc., Sakai Site



JQA-QMA15888  
Design, development, manufacture/  
manufacturing management, calibration, and  
service of measuring instruments



JQA-E-90027  
Design, development,  
manufacture, service and sales  
of measuring instruments

**CONTACT US - Global Network**

<https://www.konicaminolta.com/instruments/network/index.html>

