



KONICA MINOLTA

Ideal for measuring color temperature

Chroma Meter CL-200A

Even measures new light sources such as LED lighting and organic EL lighting



A compact, lightweight instrument with a detachable receptor. Includes convenient, easy-to-use software.

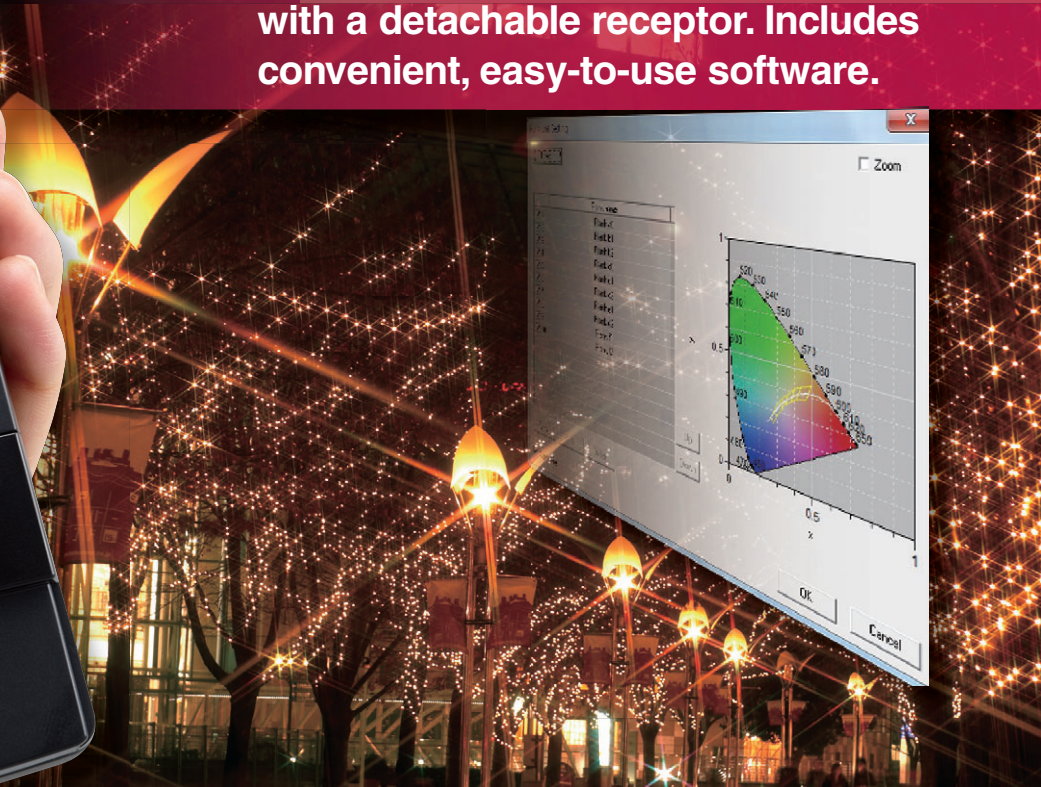

Giving Shape to Ideas

De facto industry standard for measuring color temperature!

Compact and easy to carry

The CL-200A's compact body fits in your palm. Battery-powered so it can be taken along and used anywhere.



Detachable receptor head

The receptor head can be detached and then connected to the main body using a normal LAN cable*, making it easy to install the sensor in an inspection system.

* Optional Adapter Units required for receptor head and main body

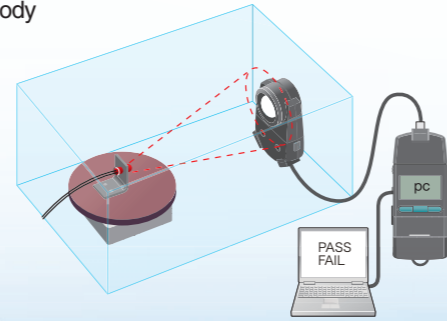

Data transfer using main body buttons

When using the CL-200A with Data Management Software CL-S10w (included), measurements can be taken and data transferred to Excel® using the main body buttons as well as computer keys.

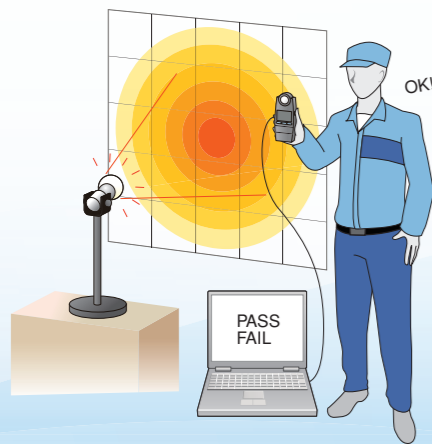

Excel® add-in software included

Easy, convenient Excel® add-in

Measurement data from the CL-200A can be transferred directly into Excel®. The transferred data can then be managed freely within Excel®.

Includes LED ranking function

Color variations, the top topic in the LED industry, can be quantified and a ranking function is also provided.

JIS correlated color temperature

Correlated color temperature is determined using the equations defined by JIS (Japanese Industrial Standards).

Multi-point measurement and user calibration also possible

Multi-point measurement management using up to 30 receptor heads is possible.

User calibration function enables compensation of measurement values to match a desired standard. Calibration can be performed by two methods: Single-point calibration or RGB calibration.

Data Management Software CL-S10w (Standard accessory)

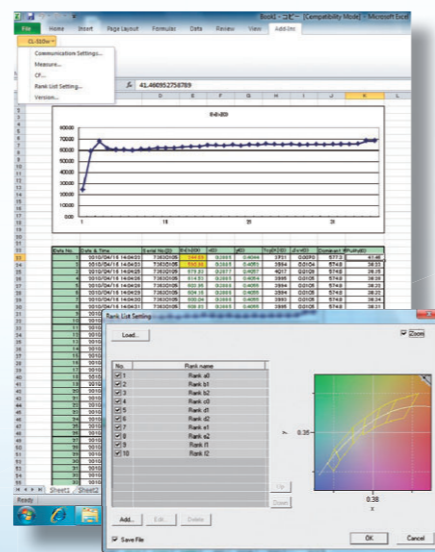

Can also measure illuminance (JIS AA class)

Measures color temperature and chromaticity!



Measures dominant wavelength!



Even measures excitation purity!



Application examples

For lighting production and adjustment

When using various types of light sources in a room or open space, it is sometimes necessary to check the color of the lighting.

By using the CL-200A, it is possible to adjust the lighting color so that the food in a restaurant looks delicious.



For evaluating light source characteristics

Evaluation of the light distribution of LED illumination modules or the illuminance distribution of lighting fixtures can be evaluated.

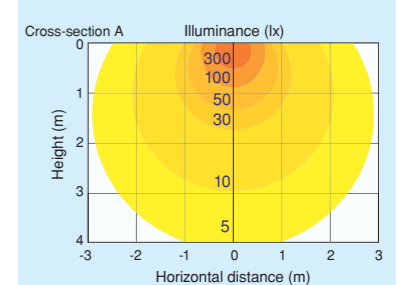

For color-viewing cabinet maintenance

A color-viewing cabinet like that shown at left is used in industries such as the printing industry to visually evaluate finished work under controlled conditions. This color-viewing cabinet provides illumination at a specific illuminance and color temperature by using fluorescent lamps, halogen lamps, etc. The CL-200A can be used for the daily maintenance and control of these lamps as well as to indicate when replacement is needed.



For projector light-source research and color inspection

The CL-200A can be used to measure the white balance and uniformity of microprojectors, etc. with internal LED light sources. The ability to connect multiple receptors using LAN cables enables measurement of not only a single point in the center, but up to a maximum of 30 points over the entire projected area.

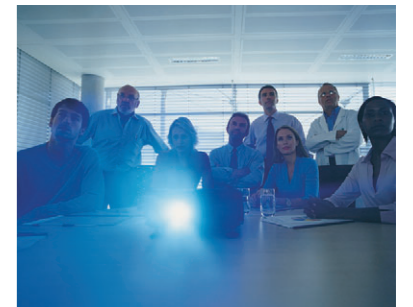

For LED billboard development and maintenance

The CL-200A enables quality control of the LED modules for digital signage to be performed easily. If modules with different color tones are used together, the billboard will look mottled, but by measuring the chromaticity and color temperature of modules using the CL-200A and selecting modules based on measured values, billboard uniformity can be achieved.



For accurate measurements of color temperature, use the CL-200A!

CL-200A

The CL-200A has sensors that closely match the CIE*-defined color-matching functions which are intended to correspond to the response of the human eye to enable precise color measurement. The measurement results can be displayed in various color notations such as "Correlated color temperature and Δuv " according to the application.

*CIE: International Commission on illumination

Photographic color meter

In order to take more beautiful pictures, it is sometimes necessary to attach filters in front of the camera lens to compensate for the color of the light illuminating the subject. A photographic color meter is a meter used to select the appropriate filters, with the sensitivity of its sensors adjusted to match that of the film or digital camera sensor. In addition, because it uses photographic color temperature, which is calculated based mostly on the blue/red balance of the illumination, large errors may occur if it is used to measure light sources with non-continuous spectrums.

[Actual measurement data for daylight-color LED bulb]

	Measured color temperature	Color-temperature difference from standard-instrument measured value
Our company's standard instrument	5,045	0
CL-200A	5,011	-34
Photographic color meter	5,600	555

Color temperature and correlated color temperature

Color temperature

When an ideal blackbody* is heated, it begins to emit light, and as the temperature increases the color of the emitted light changes from red to yellow to white. Since the color of the emitted light is determined by the temperature of the blackbody, the color of the light emitted by the blackbody can be expressed as the absolute temperature of the blackbody (in Kelvin). This color notation scale is called "color temperature". For example, a 7,000K color would be the color of the light emitted by a blackbody heated to 7,000K. Figure 1 shows the color of light emitted by a blackbody at various temperatures plotted on an xy chromaticity diagram. This curve is called the "blackbody locus"; "color temperature" expresses a color on this blackbody locus.

Correlated color temperature

Since the color of white light emitted by illumination equipment and displays is generally close to the blackbody locus, the color of such light sources is normally expressed using "color temperature".

However, the color of such light sources is not directly on the blackbody locus. Because of this, a way to enable similar color expression for colors within a larger region close to the blackbody locus was devised. This is called "correlated color temperature", and the larger region is shown by the isotherms on the xy chromaticity diagram in Figure 2.

To accurately express the correlated color temperature of a light-source color, it is necessary to state not only the correlated color temperature but the difference from the blackbody locus, normally in terms of Δuv .

*Blackbody
An ideal radiator. A body which completely absorbs all incident electromagnetic radiation. Although a perfect blackbody does not actually exist, coal is a familiar object that acts similarly.

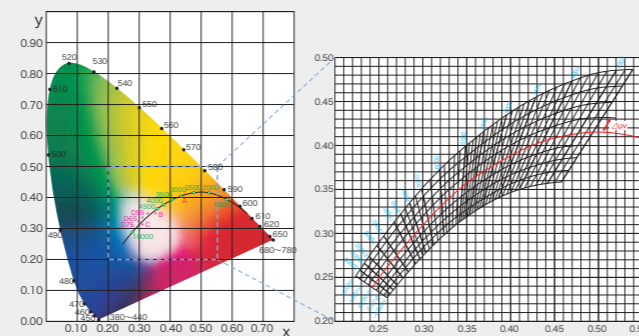

Figure 1: Blackbody locus on xy chromaticity diagram

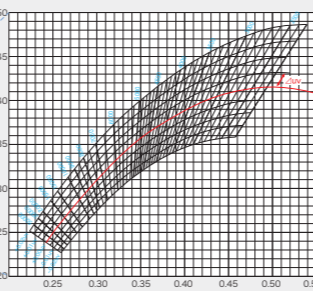

Figure 2: Closeup of blackbody locus on xy chromaticity diagram showing correlated color temperature region

General Reference Information Measurements in the LED manufacturing process

When made from blue LED and phosphor

The blue light emitted by the LED mixes with the yellow light emitted by the phosphor to create white light.

Problem:

Since the spectral emission distribution of the blue light emitted by the LED varies for each unit, variations in the resulting white light will occur. Since usually LED lamps use several LEDs, control of color mixing is necessary.

General solution:

- ① Measure the spectral emission characteristics of each LED element and rank them accordingly.
- ② Measure the emission characteristics of the phosphor and rank accordingly.
- ③ Combine the ranked LED elements and ranked phosphor materials to achieve the desired white light.
- ④ Inspect the output light quality of the final assembled white LED lamp.

Colors mix to create white light!

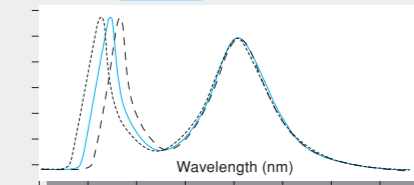
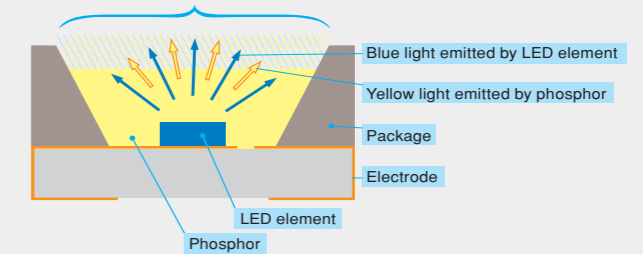

Variations in white light



How the CL-200A can help:

The CL-200A can measure the chromaticity from the phosphor and also inspect the output light quality of the final assembled white LED lamp.

Multi-point illuminance measuring system

• 5-point example: Architectural lighting, etc.

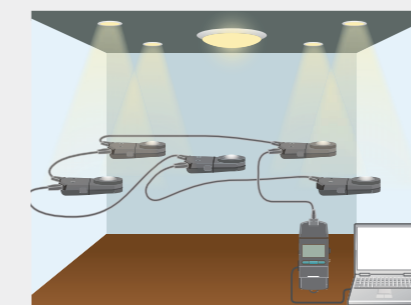

• 9-point example: Projectors, etc.

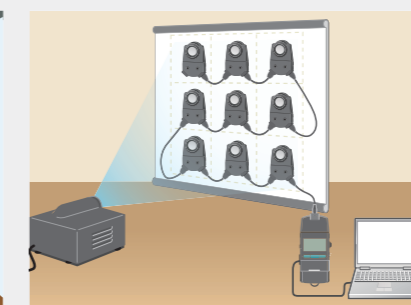

• 25-point example: Street lighting, etc.

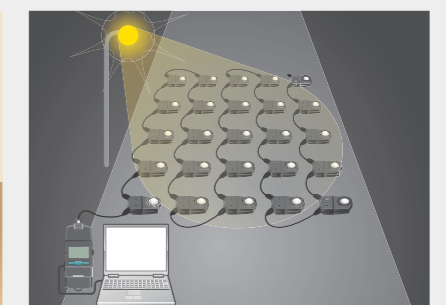

[CL-200A 9 point measuring system composition]

Chroma Meter CL-200A	1 unit
CL-200A Receptor Head	8 units
Adapter Unit for Main Body T-A20	1 unit
Adapter Unit for Receptor Head T-A21	9 units
AC Adapter	1 unit
Data Management Software CL-S10w	1 set

System Diagram

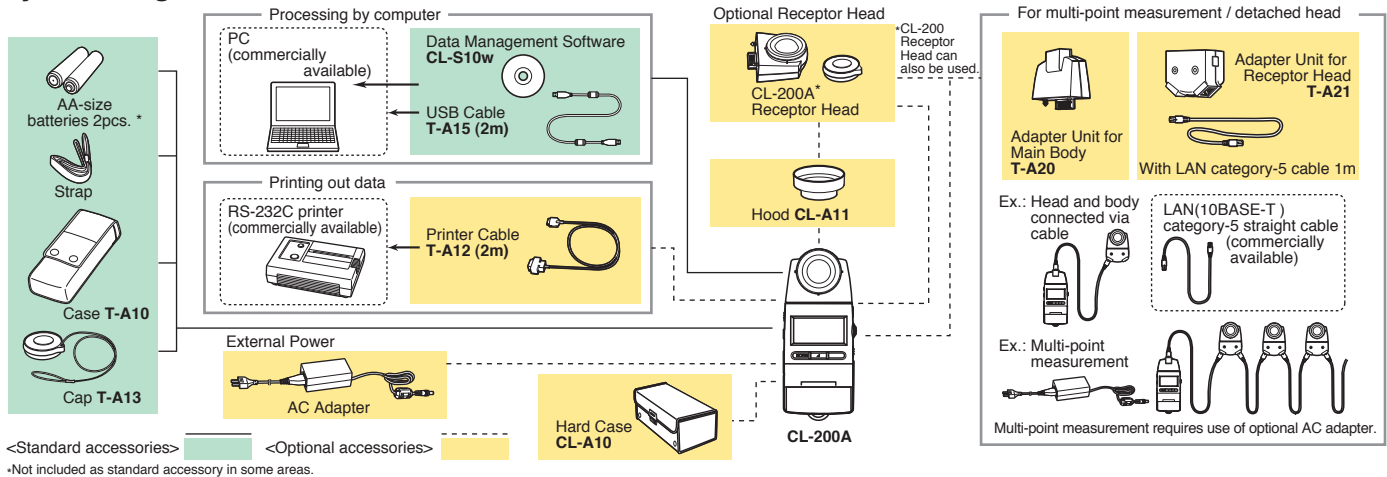

Main Specifications of Chroma Meter CL-200A

Model	Chroma Meter CL-200A
Illuminance meter class	Conforms to requirements for Class AA of JIS C 1609-1: 2006 "Illuminance meters Part 1: General measuring instruments"
Relative spectral responsivity	Closely matches CIE Standard Observer curves $\bar{x}(\lambda)$, $\bar{y}(\lambda)$, and $\bar{z}(\lambda)$ Within 6% (fi) of the CIE spectral luminous efficacy $V(\lambda)$
Cosine correction characteristics (f_2)	E_V : Within 3%
Receptor	Silicon photocell
Measuring function	Tristimulus values: XYZ Chromaticity: E_Vxy ; $E_Vu'v'$; E_V , Dominant wavelength, Excitation purity Correlated color temperature: E_VT_{cp} ; T_{cp} (JIS method; available only with CL-S10w) Color difference: $\Delta(XYZ)$, $\Delta(E_Vxy)$, $\Delta(E_Vu'v')$, $\Delta E_V \Delta u'v'$ (Target: 1)
Other function	User calibration function, Data hold function, Multi-point measurement (2 to 30 points)
Measuring range	0.1 to 99,990 lx, 0.01 to 9,999 fcd (Chromaticity: 5 lx, 0.5 fcd or above) in four automatically selected ranges (lx or fcd is switchable)
Accuracy*	E_V (Linearity): $\pm 2\% \pm 1$ digit of displayed value xy : ± 0.002
Repeatability*	E_V : $0.5\% + 1$ digit (2σ), xy : ± 0.0005
Temperature drift	E_V : $\pm 3\% \pm 1$ digit of displayed value, xy : ± 0.003
Humidity drift	E_V : $\pm 3\% \pm 1$ digit of displayed value, xy : ± 0.003
Measurement speed	2 times/sec. (continuous measurement with 1 receptor head)
Computer interface	USB
Printer output	RS-232C
Display	4-significant-digit LCD with back-light illumination
Operation temperature/humidity range	-10 to 40°C, relative humidity 85% or less (at 35°C) with no condensation
Storage temperature/humidity range	-20 to 55°C, relative humidity 85% or less (at 35°C) with no condensation
Power	2 AA-size batteries / AC adapter AC-308 (optional; for 1 to 10 receptors) or AC adapter AC-311 (optional; for 1 to 30 receptors)
Battery performance	72 hours or longer (When alkaline batteries are used) in continuous measurement
Size (W x H x D)	69x174x35mm (2-6/16x6-14/16x1-7/13in.)
Weight	215g (7.6 oz.) not including batteries

* 800 lx, Standard Illuminant A measured

Main Specifications of Data Management Software CL-S10w

Type	Add-in for Excel® * Excel is required to use this add-in.
Operating environment	One of the following environments: Windows® 7 Professional 32-bit or 64-bit + Excel® 2007 32-bit or Excel® 2010 32-bit Windows® 8.1 Pro 32-bit + Excel® 2010 32-bit or Excel® 2013 32-bit Windows® 8.1 Pro 64-bit + Excel® 2010 32-bit, Excel® 2013 32-bit, or Excel® 2013 64-bit Windows® 10 Pro 32-bit + Excel® 2013 32-bit or Excel® 2016 32-bit Windows® 10 Pro 64-bit + Excel® 2013 32-bit or 64-bit, or Excel® 2016 32-bit or 64-bit • OS languages: English, Japanese, Simplified Chinese, Traditional Chinese • For details on system requirements for above versions of Windows® and/or Excel®, refer to their respective specifications.
Compatible instruments	CL-200A, CL-200*, CL-500A * Some functions not usable with CL-200.

KONICA MINOLTA, INC.
Konica Minolta Sensing Americas, Inc.
Konica Minolta Sensing Europe B.V.

Osaka, Japan
New Jersey, U.S.A.
European Headquarter /BENELUX
German Office
French Office
UK Office
Italian Office
Swiss Office
Nordic Office
Polish Office
Turkish Office
SE Sales Division
Beijing Office
Guangzhou Office
Chongqing Office
Qingdao Office
Wuhan Office

Phone : 888-473-2656 (in USA), 201-236-4300 (outside USA)
Nieuwegein, Netherlands
München, Germany
Roissy CDG, France
Warrington, United Kingdom
Cinisello Balsamo, Italy
Dietikon, Switzerland
Västra Frölunda, Sweden
Wrocław, Poland
Istanbul, Turkey
Shanghai, China
Beijing, China
Guangdong, China
Chongqing, China
Shandong, China
Hubei, China
Singapore
Goyang-si, Korea

Fax : 201-785-2482
Fax : +31 (0) 30 24 81 211
Fax : +49 (0) 89 4357 156 99
Fax : +33 (0) 1 80 11 10 82
Fax : +44 (0) 1925 711143
Fax : +39 02849488.30
Fax : +41 (0) 43 322-9809
Fax : +48 (0) 71 73452 10
Fax : +90 (0) 212-253 49 69
Fax : +86- (0) 21-5489 0005
Fax : +86- (0) 10-8522 1241
Fax : +86- (0) 20-3826 4223
Fax : +86- (0) 23-6773 4799
Fax : +86- (0) 532-8079 1873
Fax : +86- (0) 27-8544 9991
Fax : +65 6560-9721
Fax : +82(0)31-995-6511

Konica Minolta Sensing Singapore Pte Ltd.
Konica Minolta Sensing Korea Co., Ltd.
Addresses and telephone/fax numbers are subject to change without notice. For the latest contact information, please refer to the KONICA MINOLTA Worldwide Offices web page :

©2010 KONICA MINOLTA, INC.

Dimensions (Units:mm)

With receptor head attached to main body

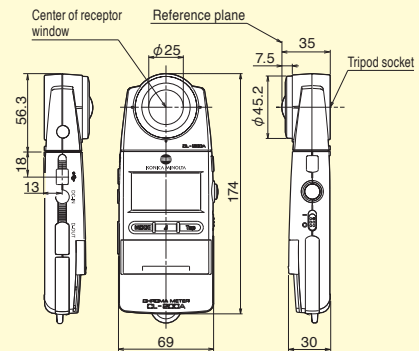

With adapter unit attached to receptor head

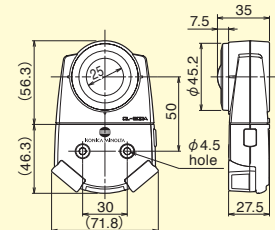

- Konica Minolta, the Konica Minolta logo and symbol mark, and "Giving Shape to Ideas" are registered trademarks or trademarks of KONICA MINOLTA, INC.
 - Windows® and Excel® are trademarks of Microsoft Corporation in the USA and other countries.
 - The specifications and appearance shown herein are subject to change without notice.
 - Screens shown are for illustration purpose only.
 - Some lamp control methods may make accurate measurements difficult.
- For details, please contact your nearest Konica Minolta sales office or dealer.

SAFETY PRECAUTIONS



For correct use and for your safety, be sure to read the instruction manual before using the instrument.

- Always connect the instrument to the specified power supply voltage. Improper connection may cause a fire or electric shock.
- Be sure to use the specified batteries. Using improper batteries may cause a fire or electric shock.

ISO Certifications of KONICA MINOLTA, Inc., Sakai Site



JQA-QMA15888
Design, development, manufacture/
manufacturing management, calibration,
and service of measuring instruments



JQA-E-80027
Design, development, manufacture/
manufacturing management, calibration,
and service of measuring instruments

<https://konicaminolta.com/instruments/network>

9242-4876-12 BJDPK16