

Spectrophotometer *CM-17d* *CM-16d*

En Instruction Manual



Please read before using the instrument.



KONICA MINOLTA



■ Notification for California Customers

Perchlorate Material - Special handling may apply,
see www.dtsc.ca.gov/hazardouswaste/perchlorate.

Official names for applications and the like used in this manual

(Wording used in text)	(Official name)
Bluetooth	Bluetooth®

Trademarks

- The Bluetooth® mark and logo are registered trademarks of The Bluetooth SIG, Inc. and are used under license.
- The KONICA MINOLTA logo and symbol marks and SpectraMagic are registered trademarks of KONICA MINOLTA, Inc.

■ Safety Symbols

The following symbols are used in this manual and on the product to prevent accidents that may occur because of incorrect use of the instrument.



Denotes an instruction regarding a safety warning or note.
Read the instruction carefully to ensure safe and correct use.



Denotes a prohibited operation.
This operation must never be performed.



Denotes an instruction.
This instruction must be strictly adhered to.



Denotes an instruction.
Be sure to disconnect the plug from the outlet.



Denotes a prohibited operation.
Never disassemble the instrument.



This symbol indicates alternating current (AC).



This symbol indicates direct current (DC).



This symbol indicates class II protection against electric shock.







Notes on This Manual









- Copying or reproduction of all or part of the contents of this manual without the permission of KONICA MINOLTA is strictly prohibited.
- The contents of this manual are subject to change without prior notice.
- Every effort has been made in the preparation of this manual to ensure the accuracy of its contents. However, should you have any questions or find any errors, please contact your retailer or a **KONICA MINOLTA-authorized service facility**.
- KONICA MINOLTA will not accept any responsibility for consequences arising from the use of the instrument.

Safety Precautions

To ensure correct use of this instrument, read the following points carefully and adhere to them. After you have read this manual, keep it in a safe place where it can be referred to anytime a question arises.

	WARNING (Failure to adhere to the following points may result in death or serious injury.)
	Do not use the instrument in places where flammable or combustible gases (gasoline, etc.) are present. Doing so may cause a fire.
	Be sure to turn the instrument OFF in areas where use is prohibited, such as in airplanes or hospitals. Using the instrument in such areas may affect the electronics and medical equipment, which may cause an accident.
	Always use the specified AC adapter (100 to 240V ~ 50/60Hz; North America or Taiwan: 100 to 120V, Japan: 100V) or one that supports USB Power Delivery (15 W or more) and conforms to national regulations plugged into an indoor outlet of the rated voltage. If an AC adapter other than those specified by KONICA MINOLTA is used, or if the adapter is connected to an unsupported voltage, it may result in damage to the adapter, fire, or electric shock.
	If the instrument will not be used for a long time, disconnect the AC adapter from the AC outlet. Accumulated dirt or water on the prongs of the AC adapter's plug may cause a fire. Clean off any dirt or water on the prongs of the AC adapter's plug before use.
	Do not insert or disconnect the AC adapter with wet hands. Doing so may cause electric shock.
	Do not disassemble or modify the instrument or the AC adapter. Doing so may cause a fire or electric shock.
	Do not operate the instrument if it or the AC adapter is damaged, or if smoke or odd smells occur. Doing so may cause a fire. In such situations, turn the power OFF immediately, disconnect the AC adapter from the AC outlet, remove the battery, and contact the nearest KONICA MINOLTA-authorized service facility .
	Do not allow liquid or metal objects to enter the instrument and the AC adapter. Doing so may cause a fire or electric shock. Should liquid or metal objects enter the instrument, turn the power OFF immediately, disconnect the AC adapter from the AC outlet, remove the battery, and contact the nearest KONICA MINOLTA-authorized service facility .
	Do not forcibly bend, twist, or pull the cords or cables. Also, do not scratch, fabricate, or place heavy objects on the cables. Doing so may damage the cable and cause a fire or electric shock.
	Firmly push the AC adapter power plug completely into the outlet. Incomplete insertion may cause fire or electric shock.
	Do not dispose of the battery in a fire or short-circuit, heat, or disassemble the battery. Doing so may cause the battery to rupture or leak, which could result in fire or injury.
	In the event that a battery leaks and the fluid comes into contact with the eyes, do not rub the eye. Wash it with clean water, and then immediately consult a doctor. If the leaked fluid comes into contact with skin or clothing, immediately rinse with water. In addition, stop using the instrument if the battery has leaked.
	Use the product (AC adapter or USB cable connection required) or the dedicated charger to charge the lithium-ion battery. If charging conditions or a charger different from that specified is used for charging, the battery may leak, overheat, or catch fire.
	When disposing of the lithium-ion battery used in this instrument, use tape or some other material to electrically insulate the contacts. Contact with other metals may cause the battery to overheat, rupture, or catch fire. Properly dispose of the lithium-ion battery according to local regulations or recycle the lithium-ion battery.

	Do not touch the battery with wet hands. Doing so may result in electric shock or a malfunction.
	Do not use, charge, or store the lithium-ion battery in a high-temperature environment. Doing so may cause the battery to overheat, catch fire, or rupture.
	Do not throw or submit the lithium-ion battery to strong impacts such as from a fall from a high location. If the lithium-ion battery is deformed or if the built-in protection system is broken, an abnormal current or voltage may be applied to the battery during charging, which may cause the battery to overheat, rupture, or catch fire.
	Do not step on the lithium-ion battery or pierce with a nail or hit with a hammer. If the lithium-ion battery is deformed or if the protection system is damaged, the battery may overheat, rupture, or catch fire.
	Should an unusual odor, heat, discoloration, deformation, or other previously unnoticed abnormality occur during use, charging, or storage, remove the battery from the instrument or charger and discontinue use. Continued use of a battery in this condition may cause the battery to overheat, rupture, or catch fire.
	If the lithium-ion battery is found to be leaking or emitting an unusual odor, keep the battery away from any open flames. The electrolytic solution from the battery may catch fire, causing rupture or fire.
	Do not look directly at the lamp. The lamp is extremely bright and emits ultraviolet rays. Looking directly at the light may injure the eyes.

	CAUTION (Failure to adhere to the following points may result in injury or damage to the instrument or other property.)
	Do not place the instrument on an unstable or sloping surface. Doing so may result in the instrument dropping or overturning, causing injury. Be careful not to drop the instrument when carrying it as well.
	Take care not to pinch yourself on the areas of the instrument that open and close. Doing so may result in injury.
	Do not use the instrument if the specimen measuring port (measurement area) is in the line of sight. Doing so may result in injury to the eye.
	Take sufficient care when handling the target mask with glass. The glass of the target mask may become cracked, resulting in injury. Also, when using a target mask with glass, be sure to use the wrist strap correctly when using the instrument.
	When using the AC adapter, make sure, that an AC outlet is located near the instrument, and that the AC adapter can be connected to and disconnected from the AC outlet easily.
	When cleaning the instrument, unplug any USB cables and remove the lithium-ion battery from the instrument. Failure to do so may result in electric shock.
	Do not use any battery other than that specified for use with the instrument. When inserting a battery into the instrument, be sure to insert the battery correctly according to the polarity (positive +, negative -) display on the instrument. Fire, injury, or stains on surroundings may occur if the battery is damaged or leaking.
	Do not use a wet lithium-ion battery. Also, do not leave a wet battery in the battery compartment. Doing so may cause the battery to rupture or overheat, which could result in fire or injury.

Introduction

The CM-17d/CM-16d is a high-precision, lightweight, and compact spectrophotometer capable of measuring color and color differences for use in a variety of industrial fields.

Packing materials of the product

Be sure to keep all packing materials used for shipping the instrument (cardboard box, cushioning material, plastic bags, etc.). This instrument is a precision measuring instrument. When transporting the instrument to a service facility for maintenance or for other reasons, be sure to use the packing materials to minimize shock or vibration. If the packing materials are lost or damaged, contact a **KONICA MINOLTA-authorized service facility**.

Notes on Use

The instrument must be used correctly. Using the instrument in a manner other than that described in the instruction manual may result in injury, electric shock, or damage to equipment.

Operating Environment

- The AC adapter for the instrument (AC-A405) has been designed exclusively for indoor use. Outdoor use is prohibited.
- This instrument is composed of precision electronic components. Never disassemble the instrument.
- Always use the specified AC adapter (100 to 240V \sim 50/60Hz; North America or Taiwan: 100 to 120V, Japan: 100V) or one that supports USB Power Delivery (15 W or more) and conforms to national regulations plugged into an indoor outlet of the rated voltage. Use an AC power supply of the rated voltage (within $\pm 10\%$).
- This instrument is a staining degree 2 product (equipment to be used primarily in manufacturing environments, laboratories, warehouses, and similar locations). This instrument should be used in environments where exposure to metallic dust or condensation is not a concern.
- This instrument is an overvoltage category I product (equipment for connection to circuits in which measures are taken to limit transient overvoltage to an appropriately low level).
- Take care to prevent foreign matter from entering the instrument. Using the instrument while subjected to intrusion of water or metals is extremely dangerous.
- Using the instrument in direct sunlight or near heating equipment can cause the internal temperature of the instrument to become much higher than the ambient temperature, resulting in malfunction. Do not use the instrument in such areas.
- Avoid subjecting the instrument to sudden temperature changes and condensation.
- Do not use the instrument in areas where dust, smoke, or chemical gases are present, or in extremely humid environments.
- This instrument should be used in an environment with an ambient temperature between 5°C and 40°C, a relative humidity of 80% (up to 35°C; the upper limit decreases linearly to 62% from 35°C to 40°C), and no condensation. Use of the instrument outside this range will result in unsatisfactory performance.
- Do not use the instrument at altitudes higher than 2,000 m.
- Do not use the instrument near equipment that produces a strong magnetic field (such as speakers).
- This instrument complies with Electrical equipment for measurement, control and laboratory use - EMC(Electromagnetic Compatibility) requirements - Part 1: General requirements (EU Harmonized Standards EN 61326-1:2021). Conformity verification is performed under KONICA MINOLTA' s test conditions in an INDUSTRIAL ELECTROMAGNETIC ENVIRONMENT specified in the relevant harmonized standards. The limit of performance degradation when subjected to continuous disturbance during immunity testing is up to twice KONICA MINOLTA's repeatability specifications (ΔE^*ab).
- To secure the instrument for use, make sure the instrument is firmly attached with no possibility of falling off. Failure to do so may result in harm to the instrument or people and objects around the instrument.

System

- Do not subject the instrument to strong vibrations or impacts.
- Do not pull, forcibly bend, or apply excessive force to the connected cables and cords. Doing so may cause the cable or cord to break.
- Do not allow the specimen measuring port of the instrument to become dirty or subject the aperture to impact. Place the instrument on the calibration stage when not in use.
- If the instrument is exposed to strong external static electricity, the LCD may go blank or fail to display information correctly. Communication with a connected external device may also be interrupted. In such cases, turn the power OFF and then ON again. If black smudges appear on the LCD, wait until they disappear naturally.
- When turning the power OFF and then ON again, wait several seconds after turning the power OFF before turning the power ON again.
- The instrument should be connected to a power source with as little noise as possible.
- When a malfunction or abnormal behavior occurs, turn the power OFF immediately, disconnect the AC adapter and the USB cable, and refer to [P. 154](#) “Troubleshooting”.
- Should the instrument break down, do not try to disassemble and repair the instrument. Contact a **KONICA MINOLTA-authorized service facility**.

Backup Battery

- Various settings are stored in the instrument’s built-in battery-powered backup memory. The backup battery will be charged when the instrument is powered or when the lithium-ion battery is being charged, regardless of whether the power switch is turned ON/OFF. The backup battery takes 20 hours to become fully charged, and there is no danger of overcharging. At full charge, the backup battery can store data for up to one year. However, the backup battery may not be fully charged when the instrument is purchased. The backup battery will charge as the instrument is being used.
- Do not attempt to replace the built-in backup battery. The battery should only be replaced by KONICA MINOLTA. To replace the backup battery, please contact a **KONICA MINOLTA-authorized service facility**.
- It is recommended to manage important data and settings using the optional SpectraMagic NX2 software.

White Calibration Plate

- The calibration data for the white calibration plate was measured at 23°C. To achieve the highest accuracy when measuring absolute values, white calibration and measurement should be performed at 23°C.
- Do not allow the white calibration plate to become scratched or dirty.
- When the white calibration plate is not in use, be sure to close the cap so that the plate is not exposed to light.

Power Source

- Make sure that the power is turned OFF when the instrument is not in use.
- This instrument should be used connected to a power supply that supports USB Power Delivery (15 W or more) or with the lithium-ion battery installed.
- Make sure the AC adapter output plug is not short-circuited. Doing so may cause a fire or electric shock.
- Do not connect the AC adapter to an overloaded electrical circuit. In addition, do not wrap or cover the AC adapter with cloth or other material while in use. Doing so may cause an electric shock or fire.
- When removing the AC adapter from the instrument, first remove the power cord from the outlet, and then remove the output plug.

Introduction (Cont.)

Battery

- Use only the standard accessory lithium-ion battery or the optional accessory lithium-ion battery CM-A235 (RRC1120). Absolutely do not use any other type of battery.
- The battery in the instrument will be charged from the power supplied through the USB cable regardless of whether the instrument is turned ON or OFF.
- The battery is not charged upon purchase and must therefore be charged.
- The battery is fully charged in approximately 3.5 hours when connected to a power supply that supports USB Power Delivery (15 W or more), and in approximately 6 hours when connected to any other power supply. There is no need to worry about overcharging.
- The lithium-ion battery will self-discharge. The battery will become unusable due to over discharging if left for a long period. Charge the battery for at least one hour using the instrument or an optional battery charger at least semiannually.
- After using up the lithium-ion battery, do not leave it uncharged.
- Charging should be performed at between 5 and 40°C. Charging will not be performed outside this temperature range.
- If the lithium-ion battery will not be used for a long period, remove the battery from the instrument and store it in a location not subject to high temperatures or high humidity.

■ Notes on Storage

- Storing the instrument in direct sunlight or near heating equipment can cause the internal temperature of the instrument to become much higher than the ambient temperature, resulting in malfunction. Do not store the instrument in such areas.
- This instrument should be stored at a temperature between 0°C and 45°C with a relative humidity of 80% or less (at 35°C) and no condensation. Storing the instrument in an environment with high temperatures and high humidity will result in unsatisfactory performance. Storing the instrument together with the drying agent at or near room temperature is recommended.
- Make sure that the instrument is not subjected to condensation when stored. In addition, take care to prevent rapid temperature changes to prevent condensation from occurring when transporting the instrument to the storage location.
- Do not store the instrument in areas where dust, smoke, or chemical gases are present. Doing so may cause deterioration in performance or a malfunction.
- Do not leave the instrument inside the cab or trunk of a vehicle. Otherwise, the temperature and/or humidity may exceed the allowable range for storage, resulting in a malfunction.
- Dust inside the specimen measuring port may prevent accurate measurements from being performed. When the instrument is not in use, cover the measuring port to prevent the intrusion of dust and the like.
- The white calibration plate may become discolored if left exposed to light. Therefore, make sure to close the cap when the plate is not in use in order to prevent the plate from being exposed to light.
- When not in use, store the instrument in the packing used for shipment or in the optional hard case and keep it in a safe place.
- Take care not to pinch yourself on the areas of the hard case that open and close. Doing so may cause injury.

■ Notes on Cleaning

- If the instrument becomes dirty, wipe it with a soft, dry cloth. Never use organic solvents (such as naphtha or thinner) or other chemicals for cleaning.
- If there is dust or dirt on the lens or the receptor window, use a blower or the like to blow it off. Never use organic solvents (such as naphtha or thinner) or other chemicals for cleaning.
- If the white calibration plate becomes dirty, wipe it with a soft, dry cloth. If the dirt is excessive, wipe with a cleaning cloth slightly moistened with ethanol. If the cleaning cloth is dirty, clean the cloth by washing it.
- If you are unable to remove dirt from the instrument through the above procedure, or if the instrument becomes scratched, contact a **KONICA MINOLTA-authorized service facility**.
- If the specimen measuring port of the instrument becomes dirty, contact a **KONICA MINOLTA-authorized service facility**.

■ Notes on Transporting

- When transporting the instrument, be sure to use the packing materials to minimize shock or vibration.
- When sending the instrument in for service, package and send the instrument and all accessories.

■ Maintenance and Inspection

- To maintain measurement accuracy, the instrument should be inspected once a year. The wavelength analysis & adjustment (WAA) function can also be added to this product by subscribing to a maintenance contract. For information on inspection, contact the nearest **KONICA MINOLTA-authorized service facility**.

■ Disposal Method

- Make sure that the instrument, all accessories (including any used batteries), and the packing materials are either disposed of or recycled correctly in accordance with local laws and regulations.
- In the United States and Canada, you can recycle your lithium-ion battery through the Call2Recycle program. For more information, in the United States visit www.call2recycle.org and in Canada visit www.call2recycle.ca.



Table of Contents

■ Safety Symbols.....	ii	□ Attaching/Removing the Target Mask	35
Notes on This Manual.....	ii	■ White Calibration Cap CM-A298	37
Introduction	3	□ Attaching to/Removing from the Instrument... ..	37
■ Notes on Use	3	Calibration.....	38
■ Notes on Storage.....	5	■ Zero Calibration	38
■ Notes on Cleaning	6	■ White Calibration	40
■ Notes on Transporting	6	■ User Calibration	42
■ Maintenance and Inspection	6	Setting a Specimen	43
■ Disposal Method	6	■ Camera Viewfinder (CM-17d Only)	43
■ Conventions.....	9	Measurement	44
□ Instrument Firmware Version	9	■ Displaying the Measurement Results.....	45
Chapter 1 Before Using the Instrument... 10		□ <Sample> Detail Screen: Absolute Value.....	45
Accessories.....	11	□ <Sample> Detail Screen: "Difference" Tab	46
■ Standard Accessories	11	□ <Sample> Detail Screen: "Abs. & Diff." Tab	46
■ Optional Accessories.....	12	□ <Sample> Detail Screen: "Pass/Fail" Tab	47
System Diagram	15	□ <Sample> Detail Screen: "Custom" Tab	47
Names and Functions of Parts	16	□ <Sample> Detail Screen: "Abs. Graph" Tab	48
■ Control Panel	17	□ <Sample> Detail Screen: "Diff. Graph" Tab.....	48
Points to Remember	18	□ <Sample> Detail Screen: "Spectral Graph" Tab... ..	49
■ Initial Settings	18	□ <Sample> List Screen	49
■ Data Saving.....	18	■ Measurement (Simple Mode)	51
□ Display (LCD Screen).....	18	Handling the Sample	53
□ Status Bar	19	■ Print Data (Sample).....	54
□ Operation Keys	20	■ Edit Name	55
■ Menus.....	21	■ Data Management (Sample).....	56
■ Cleaning Parts	24	□ Delete.....	56
□ White Calibration Cap	24	□ Set Sample as Target	57
□ Target Mask	24	□ Change Target Reference	58
□ Inside the Integrating Sphere.....	24	□ Change List Position.....	59
■ Cradle	25	□ Delete All Data (Sample)	60
□ Using the Cradle to Charge the Instrument.....	25	■ Auto Target (Sample).....	61
□ Attaching/Removing the White Calibration Cap to/from the Cradle	26	□ Auto Target (Sample)	61
■ Vertical Leveling Jig	27	□ Threshold (Sample).....	62
□ Attaching the Vertical Leveling Jig	27	Pass/Fail Judgment for Color Difference.....	63
□ Removing the Vertical Leveling Jig.....	28	■ Pass/Fail Judgment Based on Tolerances	63
Chapter 2 Measurement 30		Color Difference Target Operation	65
Flow of Measurement	31	■ Print Data (Target).....	66
Preparation	32	■ Edit Name	67
□ Attaching the Wrist Strap	32	■ Data management (Target).....	68
□ Inserting the Battery	33	□ Delete.....	68
□ Connecting the AC Adapter.....	34	□ Set Group	69
□ Turning the Power ON/OFF.....	34	□ Change List Position.....	70
□ Measurement Area Selection (CM-17d).....	35	□ Edit Target Filter.....	71
		□ Data Protection.....	72
		□ Delete All Data (Target)	73
		■ Pass/Fail	74
		□ Tolerance Settings	75
		□ Tolerance List	76

- Warning Level Settings 77
- Parametric Coefficient Settings 78
- Input Colorimetric Data 79
 - Color Space 79
 - Input Data 80
- Default Data Settings 82
 - Tolerance List 83
 - Default Tolerance Settings 84
 - Warning Level Settings 85
 - Parametric Coefficient Settings 86
 - Set Group 87

Chapter 3 Setting 90

- Measurement Condition Settings 91
 - Measurement Condition Settings 91
 - Measurement Mode 92
 - Opacity Measurement 93
 - Measurement Option Settings 95
 - Specular Component 96
 - Auto Average (1 to 10) 97
 - Manual Average (1 to 30) 98
 - SMC Function (Outlier-Free Measurement) 99
 - SMC Threshold 100
 - SMC Times 101
 - Output Minus 102
 - Observation Condition Settings 103
 - Observer/Illuminant 1 104
 - Observer/Illuminant 2 106
 - Display Settings 107
 - Display Type 108
 - Color Space 109
 - Color Difference Equation 110
 - Custom 111
- Instrument Settings 112
 - Measurement Instrument Option Settings 112
 - User Type 113
 - Display Language Settings 114
 - Date Format Settings 115
 - Clock Settings 116
 - Screen Brightness 117
 - LCD Screen Display Orientation 118
 - Beep 119
 - Auto Power Off 120
 - Password Setting 121
 - Wake On Mode Settings 122

Chapter 4 Other Functions 124

- Connecting to an External Device 125
- ◎ Connecting to a Computer 125
 - Connecting via USB Cable 126

- Connecting Via Wireless LAN/Bluetooth 127
 - Instrument Preparation 127
 - Connecting the Wireless LAN/Bluetooth Module... 127
- Communication Setup (When Using Bluetooth)... 128
 - Bluetooth Function Settings 128
 - Connecting to a Computer 130
- Communication Setup (When Using Wireless LAN Function: Ad Hoc) 131
 - Wireless LAN Function: Ad Hoc Settings 132
 - Connecting to a Computer 132
- Communication Setup (When Using Wireless LAN Function: Infrastructure) 133
 - Wireless LAN Function: Infrastructure Settings... 134
 - Connecting to a Computer 134
- ◎ Connecting to a Printer/Barcode Reader... 135
 - Printer/Barcode Reader Preparation 135
 - Instrument Preparation 136
 - Registering a Bluetooth Address 136
 - Configuring PIN Code 137
 - Printing Data 138
 - Auto Print 139
- System Settings 141
 - Calibration Setup 141
 - Calibration Interval Messages 142
 - Annual Calibration Messages 143
 - User Calibration 144
 - Zero Calibration Skip 145
 - Displaying Diagnosis Info. 146
 - Displaying the Instrument Information 147
 - Displaying the Wavelength Analysis & Adjustment (WAA) Information 148
 - JOB Function 149

Chapter 5 Troubleshooting 150

- Message List 151
- Troubleshooting 154

Chapter 6 Appendix 156

- Wavelength Correction Function (WAA*) 157
- Specifications 158
- Dimensions 160

User Equation and User Class 161

Conventions

This manual describes how to safely operate the CM-17d/CM-16d using a specific procedure to perform measurement.

Viewing Pages

Symbols used in this manual are explained below.

- * Explanatory pages are constructed as follows. (The content of the explanatory illustration will differ from the actual page.)
- * Display screenshots used in the explanations may include different content and values, and may have a different layout than the actual display.

Procedure
Indicates an operating procedure.

Settings
Describes ranges and provides explanations regarding settings for the screen in question.

Memo
Provides useful information, supplementary explanations, and similar details.

Notes
Provides essential information for correct operation of the instrument. Always read this information before operating the instrument.

Display Type

Configure the display type for the measurement results.

Memo All display types are selected when the instrument is shipped from the factory.

Operating Procedure Start the procedure from the <Measurement cond.> -<Display cond.> screen.

- 1 Use [▲] or [▼] to move the cursor to "Display type", and then press the [Confirmation] key.
The <Display type> screen is displayed.
- 2 Use [▲] or [▼] to move the cursor to the desired display type, and then press the [Confirmation] key.

Settings

- Absolute value: Displays the absolute value of the colorimetric.
- Difference: Displays the color difference against the target color. The measurement that failed the pass/fail judgment based on the tolerance will be highlighted in red.
- Abs. & Diff.: Displays the absolute value and the color difference against the target color. The measurement that failed the pass/fail judgment based on the tolerance will be highlighted in red.
- Pass/Fail: Determines whether the color difference and gloss value difference related to the target are within the tolerance range set in advance. If within the tolerance, the judgment will be displayed as "Pass". If even one difference is not within the tolerance, the judgment will be displayed as "Fail".
- Custom: Displays the display color value and index set under "Custom" as the two illuminants.
- Abs. Graph: Displays a graph of the absolute value of the colorimetric.
- Diff. Graph: Displays a graph showing the color difference against the target color.
- Spectral Graph: Displays a graph showing the spectral reflectance. The [Confirmation] key can be used to move the wavelength displaying the spectral reflectance value.

Memo A check mark means the item is selected.

- 3 After all settings have been configured, use [▲] or [▼] to move the cursor to "OK", and then press the [Confirmation] key.
The selection is confirmed and the screen returns to the previous screen.

Notes If [ESC] is pressed without pressing the [Confirmation] key, the settings will not be changed, and the screen will return to the <Display cond.> screen.

Start screen
Indicates the initial screen from which the operation is commenced.

Screenshot
Indicates the state of the screen when the operation described to the left is carried out.

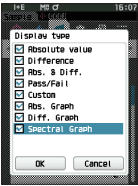
Instrument Firmware Version

The firmware version of the instrument can be viewed on the <Instrument info.> screen. For details, refer to [P. 147](#) "Displaying the Instrument Information" in this manual.

Chapter 1

Before Using the Instrument

Accessories.....	11
■ Standard Accessories	11
■ Optional Accessories.....	12
System Diagram	15
Names and Functions of Parts	16
■ Control Panel	17
Points to Remember	18
■ Initial Settings	18
■ Data Saving.....	18
■ Menus.....	21
■ Cleaning Parts.....	24
■ Cradle	25
■ Vertical Leveling Jig	27

Accessories

Standard and optional accessories are available with the instrument.

The standard and optional accessories listed here are the basic configuration and may vary depending on the region.

Memo The shape of some products may be different from those shown.

Standard Accessories

White Calibration Cap CM-A298

Used to perform calibration.

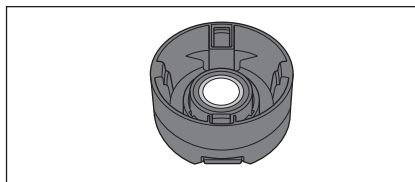

Cradle for Charging CM-A299

Used when charging the CM-17d or performing zero calibration. It can store the white calibration cap.

For the charging method, zero calibration method, and white calibration cap attachment and removal, refer to [P. 26](#).

* Optional accessory if CM-16d is purchased.

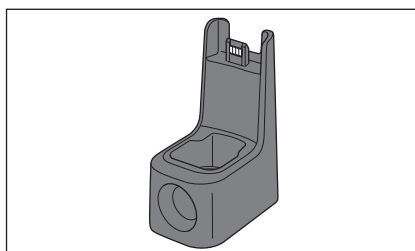

USB Cable (2m) Type-C IF-A45

Used to connect the instrument to a computer.

When using the AC adapter, power will be supplied through the cable.

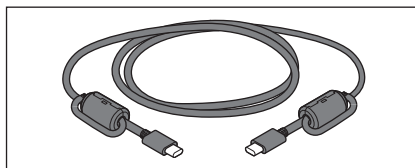

USB PD AC Adapter AC-A405

(UES60LCP-200300SPC)

Used to supply power from an AC outlet to the instrument.

Input: 100 to 240 V \sim , 50-60 Hz, 1.3 A

Output: 5 V $---$ 3 A

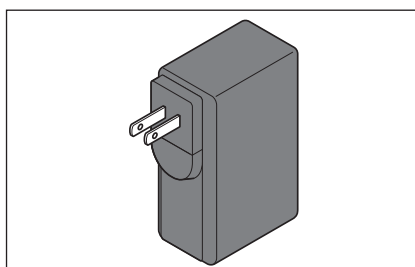

Target Mask

Used to change the illumination area (specimen measuring port) according to the specimen.

Target Mask	Ø8 mm (w/plate)	CM-A178	<for MAV>
Target Mask	Ø3 mm (w/plate)	CM-A179	<for SAV>
Target Mask	Ø8 mm (w/o plate)	CM-A180	<for MAV>
Target Mask	Ø3 mm (w/o plate)	CM-A181	<for SAV>

Memo

- The Ø8 mm target mask CM-A178 (for MAV) with a stabilizer is supplied when the instrument is shipped from the factory.
- Ø3 mm target masks CM-A179 and CM-A181 (for SAV) are not included with the CM-16d.

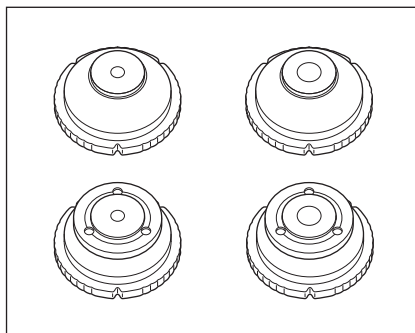

Wrist Strap CR-A73

Used to prevent users from inadvertently dropping the instrument.

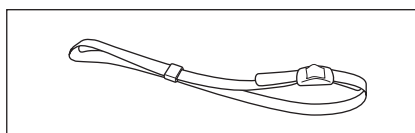

Configuration Tool CM-CT1 (Ver. 1.5 or later)

This PC software is used to configure display conditions and other settings as well as writing calibration data to measurement instruments from a computer.

Visit <https://www.konicaminolta.jp/instruments/support/download/color/cmct1/install.html>

to download the tool.

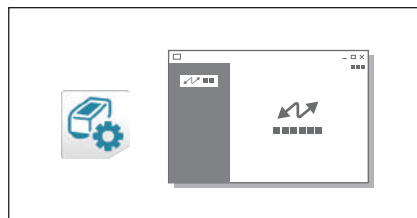

Optional Accessories

Target Mask Ø8 mm (w/glass) CM-A183

Used to measure wet, paste-like measurement objects.

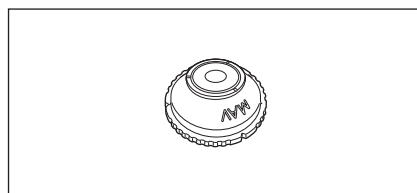

Li-ion rechargeable battery CM-A235 (RRC1120)

Insert the battery into the instrument, and connect the instrument to the AC adapter or to a computer using the IF-A28 USB cable to charge.

The battery itself can also be charged using a separately sold charger.

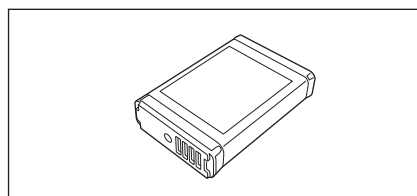

Battery Charger CM-A237 (RRC-SCC 1120)

Used as the dedicated charger to charge the lithium-ion battery.

An AC adapter for charging is included.

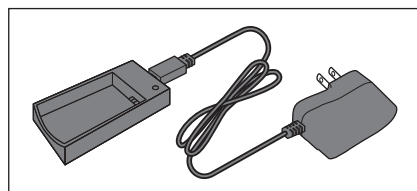

USB cable (2 m) IF-A28

Used to connect the instrument to a computer.

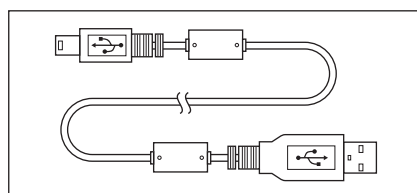

Vertical Leveling Jig CM-A304

Attached when the instrument is used with the measuring port facing up.

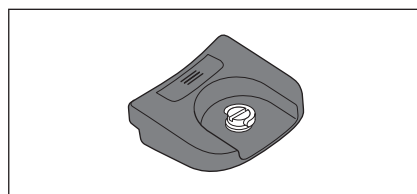

Hard Case CM-A297

Used for transporting the instrument and accessories.
May be included as a standard accessory in some regions.

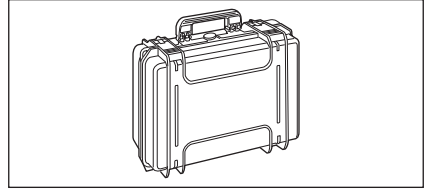

<Storage Example>

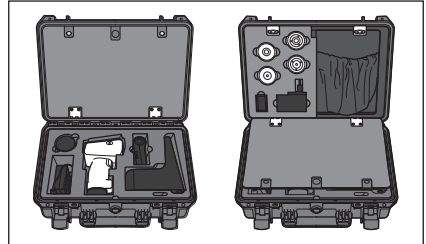

Granular-Materials Attachment CM-A184

Paste-like measurement objects, powders, etc., are placed inside so they can be measured under stable conditions.

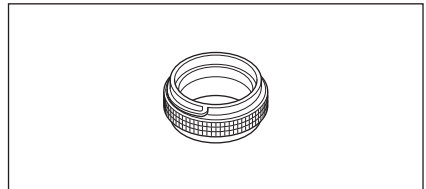

WLAN/Bluetooth Module CM-A300

Used for establishing wireless communication and transferring data between the instrument and a computer or a printer.

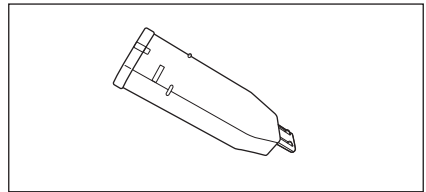

Bluetooth Printer (commercially available)

Prints out data from the instrument via Bluetooth communication.
* Only prints text. Does not print graphs.

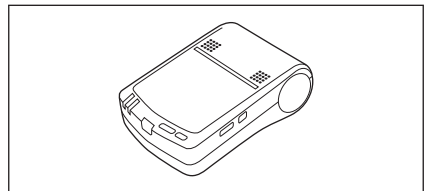

Rolled Paper (10 Rolls)

Used as printing paper for the optional printer.

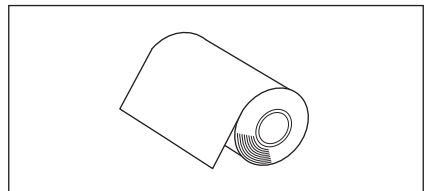

Color Plates (White, Black, and 12 Other Colors) CM-A247 to CM-A260

Used for simple diagnosis of instrument measurement performance (instrumental errors and repeatability).

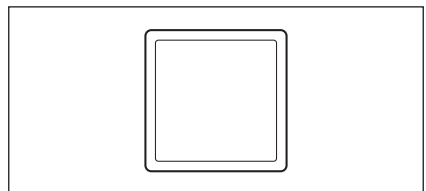

Color Data Software SpectraMagic NX2 (Ver. 1.3 or later)

A PC software used to control the instrument and manage data from a computer.

You can download it from the USB memory or

https://www.konicaminolta.jp/instruments/support/download/color/spectramagic_nx2/index.html

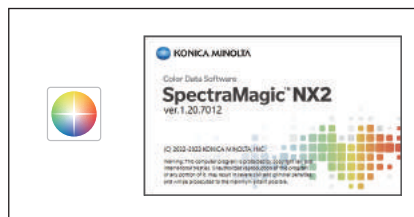

Zero Calibration Box CM-A182

Used to perform zero calibration.

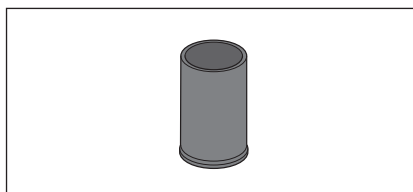

Color Tile (Green) CM-A101GN

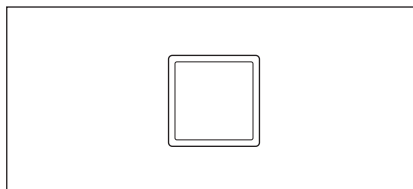

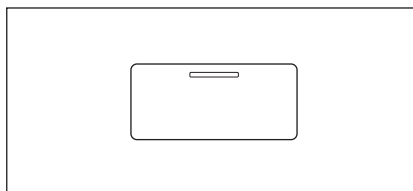

Charging Terminal Cap CM-A305

Cover that protects the charging terminal from dust when the cradle is not in use.



System Diagram

CM-17d/16d

-  Standard Accessories
-  Optional Accessories
-  Connection possible

Optional Software



Color Data Software
SpectraMagic NX2



Configuration Tool
CM-CT1
(Freely downloadable from the Web.)

Optional Accessories for connection



USB cable (2m)
Type-A - Mini-B
IF-A28**



WLAN/
Bluetooth module
CM-A300*

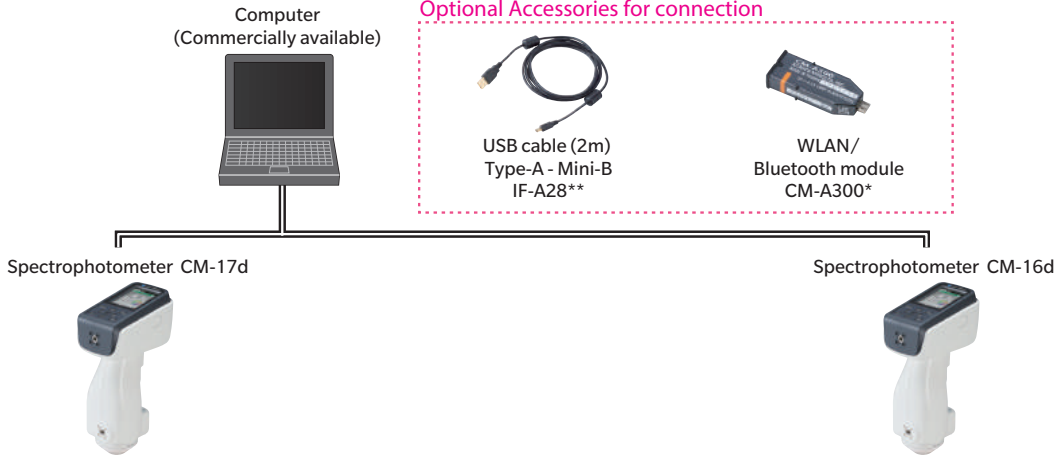





Standard Accessories for CM-17d



Cradle
for charging And Zero Calibration
CM-A299**

Target mask

			
ø8mm w/ plate CM-A178	ø8mm w/o plate CM-A180	ø3mm w/ plate CM-A179	ø3mm w/o plate CM-A181

Standard Accessories for CM-16d

Target mask

	
ø8mm w/o plate CM-A180	ø8mm w/ plate CM-A178

Standard Accessories

					
USB PD AC Adapter AC-A405*	USB cable (2m) Type-C - Type-C IF-A45**	Li-ion battery CM-A235*	White Calibration Cap CM-A298	Wrist strap CR-A73	Charging terminal cap CM-A305

Optional Accessories

					
Cradle for charging And Zero Calibration CM-A299**	Vertical Leveling Jig CM-A304**	Target mask ø8mm With glass CM-A183	Granular-materials Attachment CM-A184	Zero Calibration Box CM-A182	Hardcase CM-A297**
					
Li-ion battery CM-A235*	Li-ion battery Charger CM-A237	Color plate 14 colors CM-A247~CM-A260	Green tile CM-A101GN	Bluetooth Printer (commercially available) (Other, roll paper)	

* Depending on the location, some accessories may not be available.

** May be included as a standard accessory in some regions.

Memo The shape of some products may be different from those shown.

Names and Functions of Parts

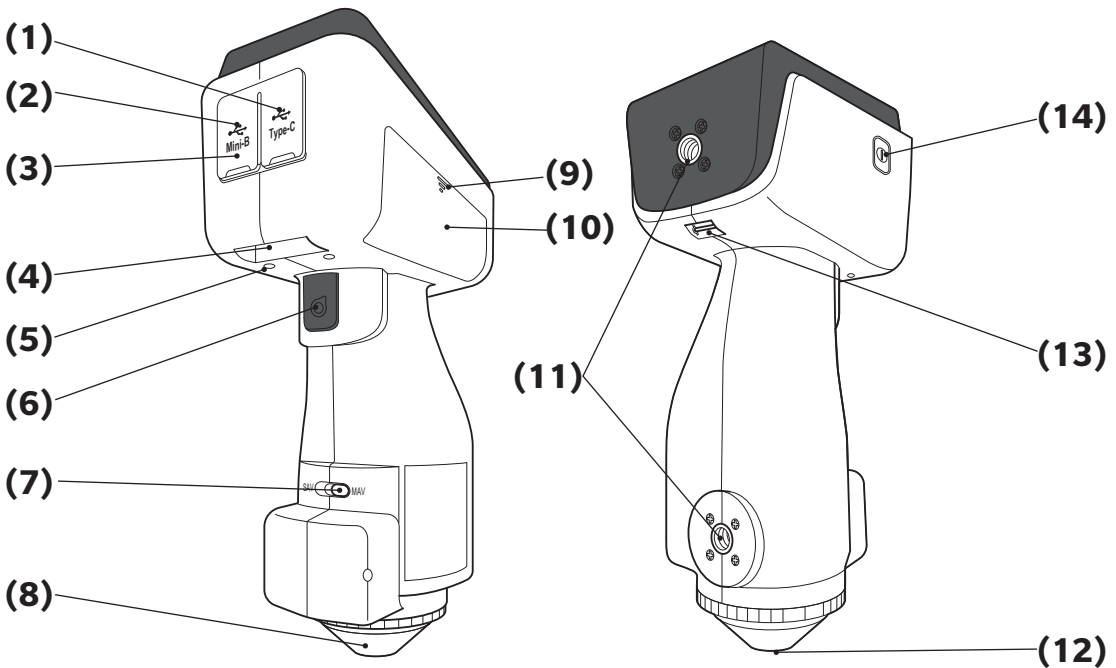

- (1) **USB Connection Terminal (Type C)** Used to connect the instrument to a computer with the supplied USB cable (IF-A45).
- (2) **USB Connection Terminal (Mini-B)** Used to connect the instrument to a computer with the specified USB cable (IF-A28).
- (3) **Connector Protection Cover** Cover that protects USB connection terminals (1) and (2).
- (4) **Charging Terminal** Used when charging the instrument using the cradle.
- (5) **Charging Terminal Cap** Cover that protects the charging terminal from dust when the cradle is not in use.
- (6) **Measurement Button** Press to calibrate or measure.
- (7) **Measurement Area Switch** Operated to switch the lens position according to the measurement area.

Memo

The CM-16d does not include this switch.
- (8) **Target Mask** The illumination area can be changed according to the setting of the measurement area switch, and the mask can also be replaced according to the application.

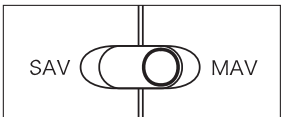

- (9) **Open/Close Part of Battery Compartment Cover** Press to open and close the battery compartment cover.
- (10) **Battery Compartment Cover** Slide this cover open when charging the battery or attaching the wireless LAN/Bluetooth module.
- (11) **Jig Mounting Screw Holes** Used for mounting accessories to the instrument.
(For mounting screws, use 1/4-20UNC.)
- (12) **Specimen Measuring Port** Port for measuring the specimen. The port diameter can be changed by replacing the target mask.

Notes The measurement area cannot be changed if using the CM-16d.
- (13) **Strap Holder** Used to attach the included wrist strap.

Memo For the attachment method, refer to P.32 "Attaching the Wrist Strap" in this manual.
- (14) **Power Switch** Used to turn the power ON/OFF. The instrument switches between ON/OFF every time the power switch is pressed.

■ Control Panel

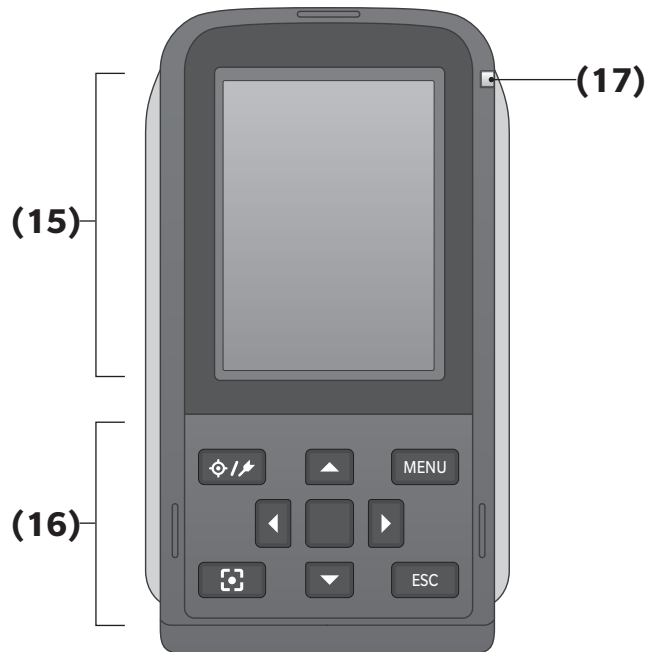
The front of the instrument contains the LCD screen, upon which the instrument displays measurement results and messages, and the control keys, which are used to set measurement options or to change displays.



(15) LCD Screen

Displays setting items, measurement results and messages.

(16) Control Panel

Used to switch screens or select/determine/save setting items. For details, refer to P. ** "Operation Keys".

(17) Charging Lamp

Lights up orange when charging via USB power. When charging is complete, the lamp will turn blue.

Points to Remember

Initial Settings

When first turning the instrument ON after purchasing, the language setting screen will be displayed. Please select the language.

The display language can be selected from 11 languages including English.

For details, refer to P. 112 “Measurement Instrument Option Settings”.

The language selection menu can be displayed by turning ON the instrument while holding down [MENU].

Data Saving

Data used with this instrument are saved automatically within the instrument.

Data on the instrument can also be imported to a computer using the optional accessory Color Data Software SpectraMagic NX2.

Display (LCD Screen)

The LCD screen displays measurement settings, measurement results, and messages. It also indicates the status of the instrument with icons.

The basic screen layout is shown below.

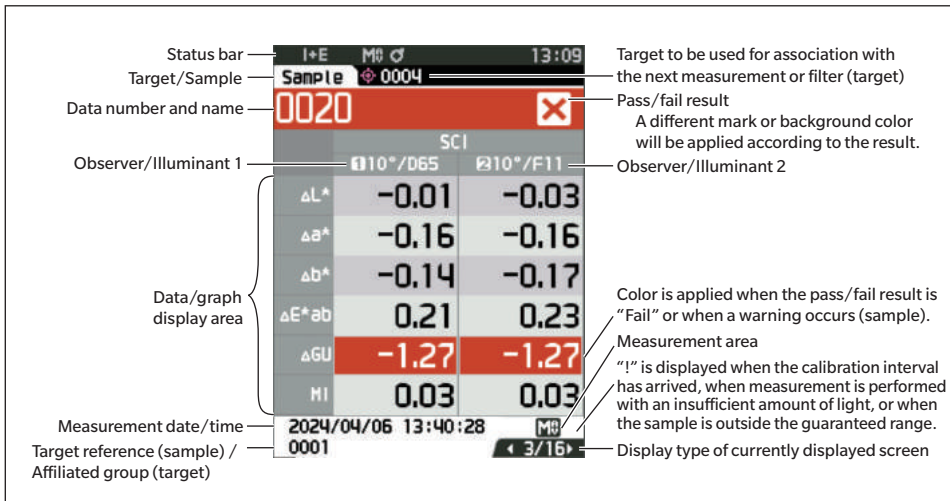

□ Status Bar

This section describes the icons displayed at the top of the screen.

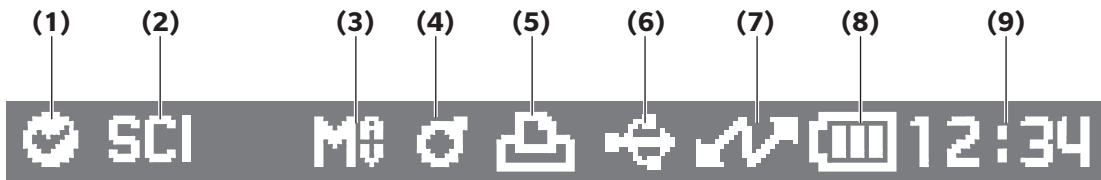

	Display	Description (Status)	Meaning
(1)	/ /None	Instrument diagnosis result (* Support for this function is planned with optional PC software. It is not currently available.)	Pass / Check required / No diagnosis result
(2)	/ /	Specular component status	SCI / SCE / SCI+SCE
(3)	/	Measurement area	MAV / SAV
(4)	/ /	Calibration status	Measurement possible / Measurement possible (calibration recommended) / Calibration required
(5)	/None	Auto print	Auto print ON / OFF
(6)	/ / /None	Communication type	USB communication ON / Bluetooth communication ON / Wireless LAN communication ON / None
(7)	/ /None	Communication status	Communication ON / Communication key ON / Communication OFF
(8)	/ / / / / / / /	Power status	Battery capacity (Full/OK/Low) / Charging / Battery degradation status (Full/OK/Low/None) / No battery
(9)		Current time	Hour:Minute

□ Operation Keys

Use these keys to set items or change screens according to the guide on the LCD screen.

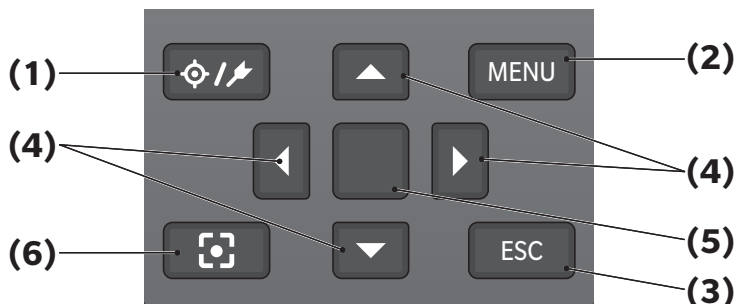

- (1) [**⚙️/⚡**] (**Target/Sample**) key Switches between **<Target> screen** and **<Sample> screen**.
- (2) [**MENU**] key Displays the **<Settings> screen**.
- (3) [**ESC**] key Returns to the previous screen without configuring the settings when pressed on the **<Settings> screen**, and returns to list screen when pressed on the sample details screen.
- (4) [**◀, ▶, ▲, ▼**] keys Switches screen tabs from the **Results Display screen**, moves the cursor on the **<Settings> screen**, or changes the selected value.
- (5) [**Confirmation**] key Sets the item or setting indicated by the cursor on the various setting screens. This key also switches to detail screens for data selected in the list displayed on the **Results Display screen**.
- (6) **Camera Viewfinder key** Displays the measurement point confirmation screen. Also closes the measurement point confirmation screen to return to the **<Target>** or **<Sample>** screen.
The measurement point confirmation screen can also be launched by pressing and holding the measurement button (at least 0.5 seconds).

Menus

Target menu

Print data [P. 66](#)

Edit name [P. 67](#)

Data management

Delete data [P. 68](#)

OK/Cancel

Set group [P. 69](#)

OK/Cancel

Edit group

Change list position [P. 70](#)

Target number selection

Edit Target filter [P. 71](#)

OFF / only saved data / only group

Protect data [P. 72](#)

OFF/ON

Delete all data [P. 73](#)

OK/Cancel

Pass/Fail

Edit tolerance [P. 75](#)

OK/Cancel

Tolerance list [P. 76](#)

Index selection

Warning level [P. 77](#)

0 to 100%

Parametric coef. [P. 78](#)

l (CMC), c (CMC),
l (ΔE^*94), c (ΔE^*94),
l ($\Delta E94S$),
c ($\Delta E94S$),
h ($\Delta E94S$),
l ($\Delta E00$), c ($\Delta E00$),
h ($\Delta E00$)

Input Colorimetric data

Color space [P. 79](#)

XYZ / L*a*b* / Hunter Lab

Input Data [P. 80](#)

Sample menu

Print data [P. 54](#)

Edit name [P. 55](#)

Data management

Delete data [P. 56](#)

OK/Cancel

Set Sample as Target [P. 57](#)

Target number selection

Change Target reference [P. 58](#)

Target number selection

Change list position [P. 59](#)

Sample number selection

Delete all data [P. 60](#)

OK/Cancel

Auto Target

Auto Target [P. 61](#)

OFF/ON

Threshold [P. 62](#)

0.01 to 9.99

Measurement cond.

Measurement mode [P. 92](#)

Color/Opacity

Measurement setup

Specular Component [P. 96](#)

SCI / SCE / SCI+SCE

Auto average [P. 97](#)

1 to 10 times

Manual average [P. 98](#)

1 to 30 times

Manual average option (SMC average option) [P. 98](#)

Manual save / Auto save

SMC [P. 99](#)

OFF/ON

SMC Threshold [P. 100](#)

0.01 to 9.99

SMC Times [P. 101](#)

3 to 10 times

Output Minus [P. 102](#)

OFF/ON

Observer/Illuminant

Observer/Illuminant 1 [P. 104](#)

2°A/C/D50/D65/ID50/
ID65/F2/F6/F7/F8/F10/
F11/F12/LED-B1/LED-B2/
LED-B3/LED-B4/LED-B5/
LED-BH1/LED-RGB1/
LED-V1/LED-V2/User1/
User2/User3
10°A/C/D50/D65/ID50/
ID65/F2/F6/F7/F8/F10/
F11/F12/LED-B1/LED-B2/
LED-B3/LED-B4/LED-B5/
LED-BH1/LED-RGB1/
LED-V1/LED-V2/User1/
User2/User3

Observer/Illuminant 2 [P. 106](#)

2°A/C/D50/D65/ID50/
ID65/F2/F6/F7/F8/F10/
F11/F12/LED-B1/LED-B2/
LED-B3/LED-B4/LED-B5/
LED-BH1/LED-RGB1/
LED-V1/LED-V2/User1/
User2/User3
10°A/C/D50/D65/ID50/
ID65/F2/F6/F7/F8/F10/
F11/F12/LED-B1/LED-B2/
LED-B3/LED-B4/LED-B5/
LED-BH1/LED-RGB1/
LED-V1/LED-V2/User1/
User2/User3/None

Display cond.**Display type** [P. 108](#)

Absolute value, Difference,
Abs. & Diff., Pass/Fail,
Custom, Abs. Graph, Diff.
Graph, Spectral Graph

Color space [P. 109](#)

L*a*b*, L*C*h, Hunter Lab,
Yxy, XYZ, Munsell (C)

Equation [P. 110](#)

ΔE^*ab , CMC, ΔE^*94 ,
 ΔE^*94 (Special),
 $\Delta E00$, ΔE (Hunter),
 $\Delta E99o$, FMC2

Custom 01 to 14 [P. 111](#)

L*, a*, b*, ΔL^* , Δa^* , Δb^* , C*, h,
 ΔC^* , ΔH^* , L, a, b, ΔL , Δa , Δb ,
X, Y, Z, DXYZ, DX, DY, DZ, ΔX ,
 ΔY , ΔZ , x, y, Δx , Δy , H, V, C,
 ΔE^*ab , CMC, ΔE^*94 ,
 ΔE^*94 (Special), $\Delta E00$,
 ΔE (Hunter), MI, Wle, ΔWle ,
Wlc, ΔWlc , Tint, $\Delta Tint$, Yle,
 ΔYle , Yld, ΔYld , B, ΔB , $\Delta E99o$,
Greyscale (ISO A105),
 $8^\circ GU$, $\Delta 8^\circ GU$, K/S St (ΔE^*),
K/S St (MAX Abs), K/S St
(Apparent), Staining ISO
105-A04, FMC2, ΔL (FMC2),
 $\Delta Cr-g$ (FMC2), $\Delta Cy-b$ (FMC2),
Blackness (My),
 $\Delta Blackness$ (My),
Jetness (Mc), $\Delta Jetness$ (Mc),
Undertone (dM),
 $\Delta Undertone$ (dM), UE1, UC1,
UE2, UC2, UE3, UC3, ---
(None)

Setting**Instrument Mode**

Normal/Simple

Default data setup [P. 82](#)**Tolerance list**

ΔL^* , Δa^* , Δb^* , ΔC^* , ΔH^* , ΔL , Δa ,
 Δb , ΔX , ΔY , ΔZ , Δx , Δy , ΔE^*ab ,
CMC, ΔE^*94 , ΔE^*94 (Special),
 $\Delta E00$, ΔE (H), MI, ΔWle , ΔWlc ,
 $\Delta Tint$, ΔYle , ΔYld , ΔB , $\Delta E99o$,
DXYZ, DX, DY, DZ, ΔOP
GS, K/S St (ΔE^*),
K/S St (MAX Abs),
K/S St (Apparent),
Staining ISO 105-A04, FMC2,
 ΔL (FMC2), $\Delta Cr-g$ (FMC2),
 $\Delta Cy-b$ (FMC2), $\Delta 8^\circ GU$,
 $\Delta Blackness$ (My),
 $\Delta Jetness$ (Mc),
 $\Delta Undertone$ (dM)

Default tolerance [P. 84](#)

OK/Cancel

Warning level [P. 85](#)

0 to 100%

Parametric coef. [P. 86](#)

I (CMC), c (CMC), I (ΔE^*94),
c (ΔE^*94), h (ΔE^*94),
I ($\Delta E94S$), c ($\Delta E94S$),
h ($\Delta E94S$), I ($\Delta E00$), c ($\Delta E00$),
h ($\Delta E00$)

Set group [P. 87](#)

Group number selection →
Group name setting

Calibration setup**Calibration interval** [P. 142](#)

01 to 24 hours

Annual calibration [P. 143](#)

OFF/ON

User calibration [P. 144](#)

OFF/ON

Zero cal. skippable [P. 145](#)

Disable/Enable

Communication setup**Auto print** [P. 139](#)

OFF/ON

Wireless Setting	P. 127
	OFF / Bluetooth / AdHoc / Infrastructure1 / Infrastructure2 / Infrastructure3 / Infrastructure4

WLAN Info.	
	Wireless LAN method, IP address, SSID, version information display

Meter PIN code	P. 128
	4 to 8 digits (Initial value is "0000")

Printer address	P. 136
	000000000000

Printer PIN code	P. 137
	4 to 8 digits (Initial value is "0000")

Scanner address	P. 136
	000000000000

Scanner PIN code	P. 137
	4 to 8 digits (Initial value is "0000")

Instrument setup

User type	P. 113
	Administrator / Worker

Language	P. 114
	English / 日本語 / Deutsch / Français / Español / Italiano / 中文 / Português / Polski / Русский язык / Türkçe

Date format	P. 115
	[yyyy/mm/dd]/[mm/dd/ yyyy]/[dd/mm/yyyy]

Date & time	P. 116
	0000/00/00 00:00

Brightness	P. 117
	5/4/3/2/1

Direction	P. 118
-----------	--------

Beep	P. 119
	OFF/ON

Auto power off	P. 120
	00 to 60 minutes

Password Setting	P. 121
	8 digits (Initial value is "00000000")

Wake On Mode	P. 122
	OFF/ON

Diagnosis info.	P. 146
WAA info.	P. 148

License, Expiration Date

Diagnosis info.	
-----------------	--

Instrument info.	P. 147
------------------	--------

Product name, Version, Serial number

Calibration

Calibration (Excluding Zero Cal.)	P. 40
White calibration	

Calibration (Including Zero Cal.)	P. 38
Zero calibration → White calibration	

JOB

JOB 1 to 5

■ Cleaning Parts

- When a white calibration plate becomes dirty, gently wipe the dirt off with a soft dry cloth. If the dirt is difficult to remove, wipe it off with a cloth dampened with commercially available lens cleaning solution. Then remove the solution with a cloth dampened with water, and leave the plate to dry.
- When a part other than the white calibration plate becomes dirty, lightly wipe the dirt off with a cloth dampened with water or soapy water. Never use solvents such as thinner or naphtha.

□ White Calibration Cap

- When a white calibration plate becomes dirty, gently wipe the dirt off with a soft dry cloth.
- If the dirt on the white calibration plate does not come off easily, wipe using a cloth soaked in ethanol.
- When a part other than the white calibration plate becomes dirty, lightly wipe the dirt off with a cloth dampened with water or soapy water.

- Notes**
- **Be careful not to scratch the white calibration plate.**
 - **Never use solvents such as thinner or naphtha.**
 - **Scratches or dirt on the white calibration plate may affect measurement values.**

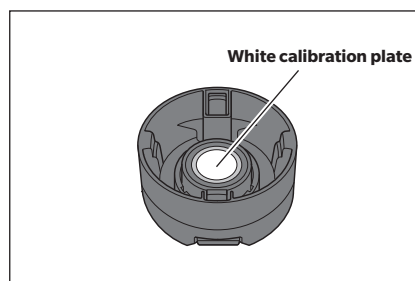

□ Target Mask

Target mask Ø8 mm (with stabilizer) CM-A178 <for MAV>

Target mask Ø3 mm (with stabilizer) CM-A179 <for SAV>

Target mask Ø8 mm (without stabilizer) CM-A180 <for MAV>

Target mask Ø3 mm (without stabilizer) CM-A181 <for SAV>

- Use a blower to blow off dirt or dust on the target mask.
- If the dirt on the outside surface of the target mask does not come off easily, wipe using a soft cloth soaked in ethanol.

- Notes** **Do not touch the painted surface of the integrating sphere.**

Target mask Ø8 mm (with glass)

- Use a blower to blow off dirt or dust on the target mask.
- If the dirt on the outside or inside surface of the target mask does not come off easily, remove the target mask from the instrument, and wipe the target mask using a soft cloth soaked in ethanol.

- Notes**
- **Take sufficient care when handling the target mask with glass.**
The glass of the target mask may become cracked, resulting in injury.

□ Inside the Integrating Sphere

- Remove the target mask.

Memo To attach/remove the target mask, refer to P. ** "Attaching/Removing the Target Mask".

Use a blower to blow off dust or dirt inside the integrating sphere.

- Notes**
- **Do not touch the white-coated inner surface of the integrating sphere, wipe it with a cloth or put an object inside it. If the target mask is dirty, and the dirt cannot be removed by a blower or the like, contact a KONICA MINOLTA-authorized service facility.**

■ Cradle

The CM-17d comes with a cradle (charging stand) as an accessory. The cradle serves the following three roles.

- (1) Allows the instrument to be charged by connecting the AC adapter to the cradle.
- (2) Allows zero calibration to be performed by using the cradle. → Refer to [P. 38 Calibration > Zero Calibration](#).
- (3) Can store the white calibration cap.

□ Using the Cradle to Charge the Instrument

Operating Procedure

- 1 **Connect the USB Type-C cable (2 m) IF-A45.**

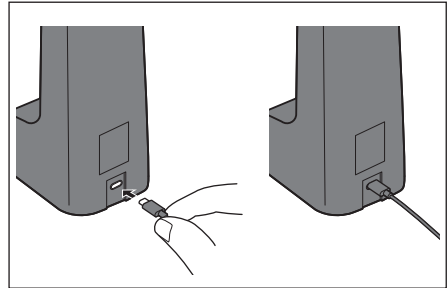

- 2 **Connect the USB PD AC adapter (AC-A405) and the USB cable, and then connect the AC adapter to the power supply.**

Memo The instrument can also be charged by connecting the cable to the USB terminal of a PC, etc.

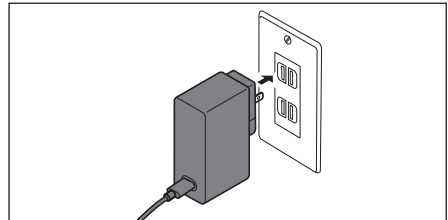

- 3 **Plug the charging terminal of the instrument into the charging terminal of the cradle to start charging. While charging, the charging lamp will light up orange. When charging is complete, the lamp will turn blue.**

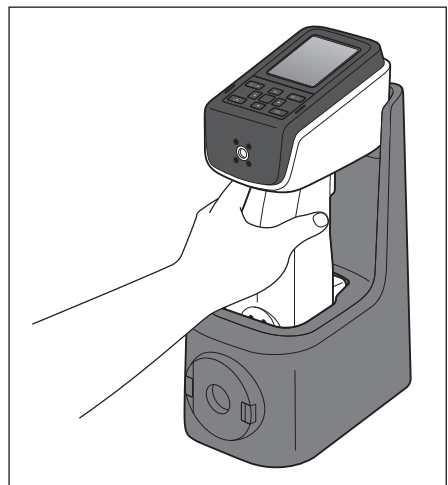

□ Attaching/Removing the White Calibration Cap to/from the Cradle

Operating Procedure

- 1 Attach the white calibration cap by pushing it onto the front of the cradle until a click is heard.**
- 2 Remove the white calibration cap by pinching the two knobs and pulling it toward you.**

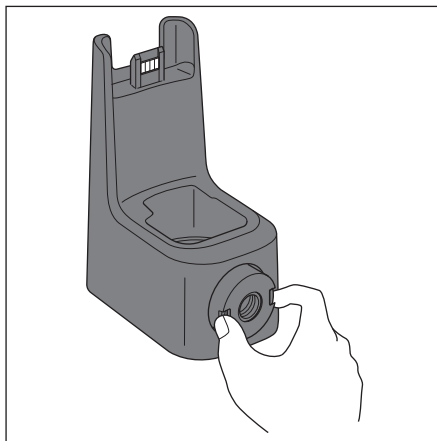

■ Vertical Leveling Jig

Attached and used when measuring with the CM-17d/16d with the measuring port facing upward.

□ Attaching the Vertical Leveling Jig

1 Tilt the instrument sideways.

Memo If a cradle is available, the vertical leveling jig can be mounted stably while the instrument is placed on the cradle.

2 Place the vertical leveling jig so that it aligns with the top of the control panel.

Memo Fix the vertical leveling jig in place so that the vertical leveling jig (rib) is touching the cover on the top of the control panel.

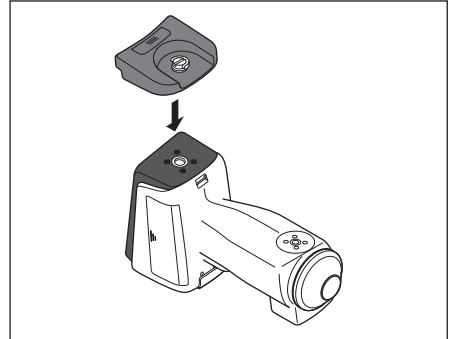
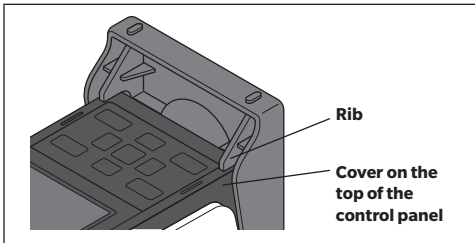

3 Insert the vertical leveling jig screw into the jig mounting screw hole in front of the control panel.

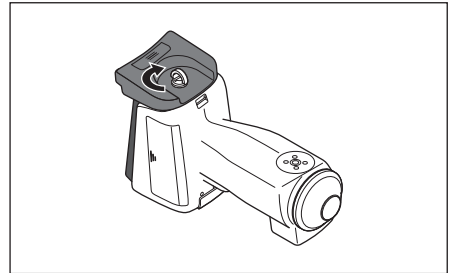

4 With the knob in the upright position, turn the vertical leveling jig screw clockwise to tighten it, and then push the knob so that it lays flat.

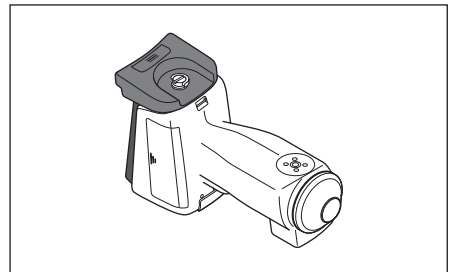

Memo When measuring, position the CM-17d/16d with the measuring port facing upward and place the measurement object on it.

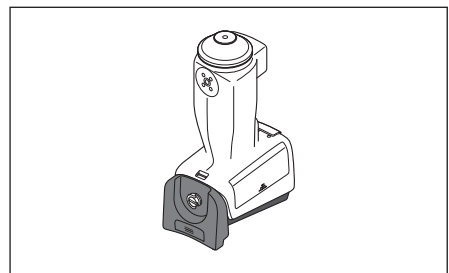

□ Removing the Vertical Leveling Jig

- 1 Insert your fingernails into the indentation on the knob and raise the knob.

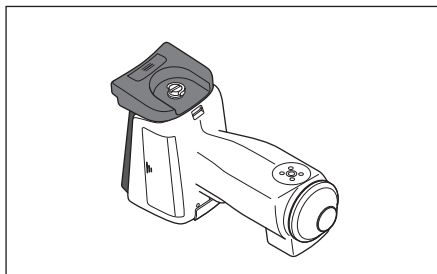

- 2 Hold the knob and turn the screw counterclockwise to loosen it.

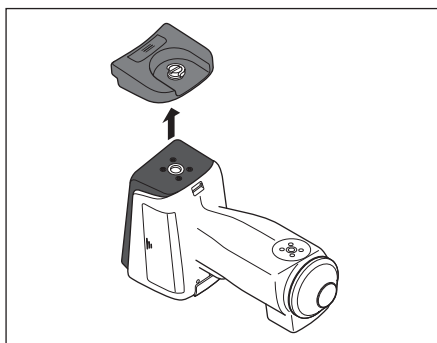
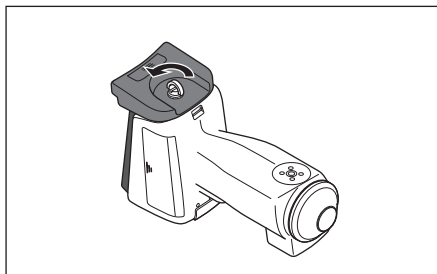

Chapter 2

Measurement

Flow of Measurement	31
Preparation	32
■ White Calibration Cap CM-A298	37
Calibration.....	38
■ Zero Calibration	38
■ White Calibration	40
■ User Calibration	42
Setting a Specimen	43
■ Camera Viewfinder (CM-17d Only)	43
Measurement	44
■ Displaying the Measurement Results	45
■ Measurement (Simple Mode)	51
Handling the Sample	53
■ Print Data (Sample)	54
■ Edit Name	55
■ Data Management (Sample).....	56
■ Auto Target (Sample).....	61
Pass/Fail Judgment for Color Difference.....	63
■ Pass/Fail Judgment Based on Tolerances	63
Color Difference Target Operation	65
■ Print Data (Target).....	66
■ Edit Name	67
■ Data management (Target).....	68
■ Pass/Fail	74
■ Input Colorimetric Data.....	79
■ Default Data Settings.....	82

Flow of Measurement

■ Optional settings

■ Basic procedure

■ Simple measurement

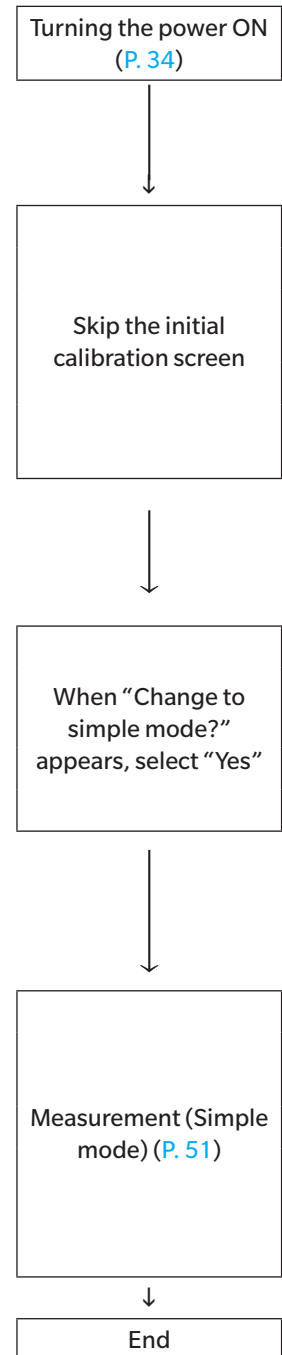
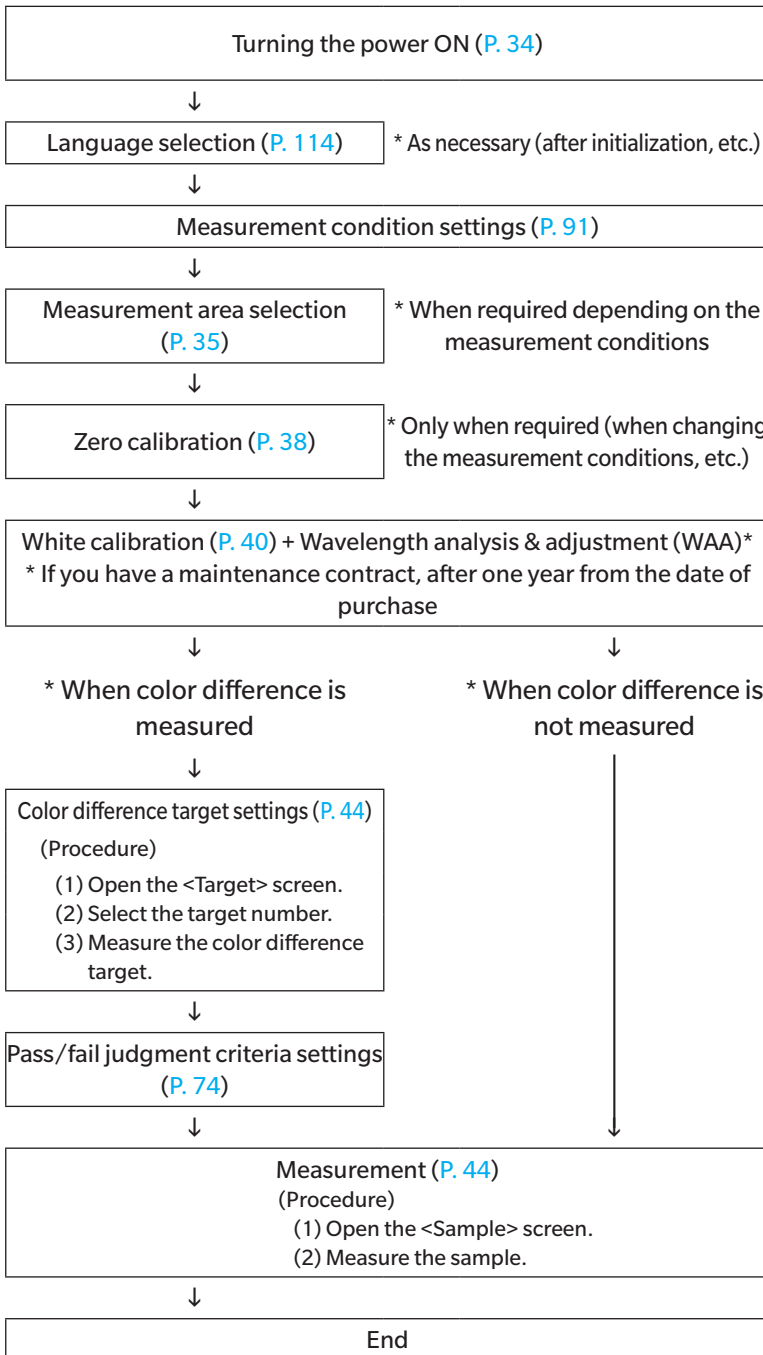

* Configure measurement/ observation conditions and perform calibration as necessary.

Preparation

□ Attaching the Wrist Strap

When using the instrument by holding it in your hand, attach a wrist strap and pass it under your arm to prevent the instrument from being dropped.

Operating Procedure

- 1 Pass one end of the wrist strap through the strap holder of the instrument.

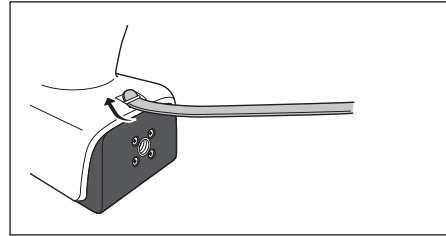

- 2 Pass the other end of the strap through the ring, and then fold the end of the strap through the strap holder and pass it through the ring.

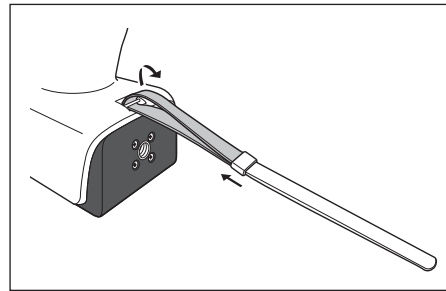

- 3 Pass one end of the strap that has been passed through the ring through the buckle.

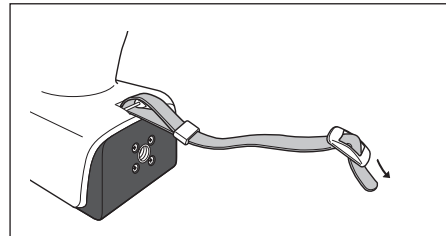

- 4 Pass the other end through the buckle from the opposite direction of the direction from which the strap was first passed through the buckle.

Memo After passing the strap under your arm, move the ring to tighten the loop of the strap as necessary during use.

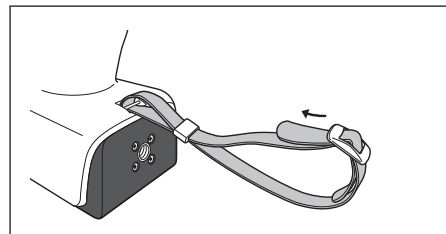

□ Inserting the Battery

This instrument can be powered from a lithium-ion battery, but use of the AC adapter or USB bus power is recommended for extended periods of use. A lithium-ion battery installed in the instrument will be charged whenever the AC adapter or USB bus power is used, regardless of whether the instrument is turned ON or OFF.

Notes When using USB bus power, use a computer that meets IEC 62368-1 (Audio/video, information and communication technology equipment - Part 1: Safety requirements) standards.

⚠ CAUTION

- Do not touch or short-circuit the terminals in the battery compartment. Doing so may damage the instrument.

Operating Procedure

1 Turn the power OFF by operating the power switch.

2 Slide open the battery cover on the bottom of the instrument.

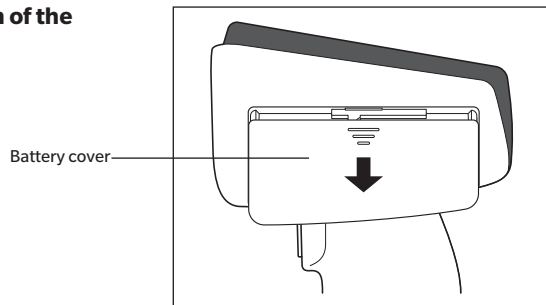

3 Rotate the battery retainer and insert the lithium-ion battery. (Follow the indications in the battery compartment to avoid confusing the battery polarity.)

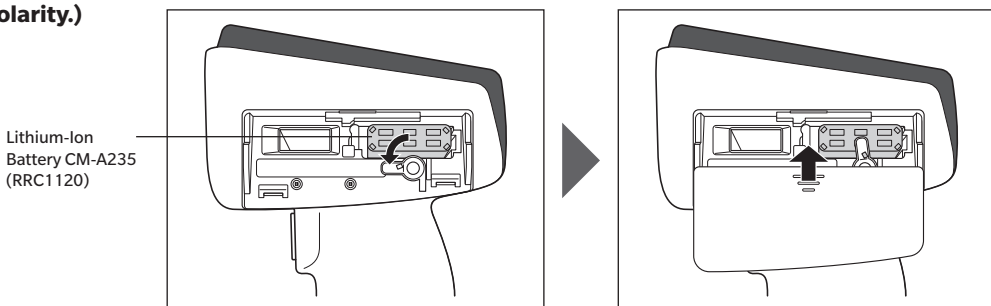

4 Slide the battery cover to close it.

□ Connecting the AC Adapter

- Notes**
- To supply AC power to the instrument, always use the AC adapter (AC-A405) supplied with the instrument.
 - Firmly push the AC adapter power plug or USB cable completely into the outlet.

Memo / Powering the instrument from the USB cable will charge the installed lithium-ion battery. While the battery is charging, the charging lamp on the instrument's panel will light up orange. When charging is complete, the lamp will turn blue.

Operating Procedure

- 1 Open the protective cover for the connector of the type of USB cable to be connected, and connect the USB cable to the USB port on the instrument.
- 2 Connect the USB cable to the AC adapter, and then connect the AC adapter to a power outlet.

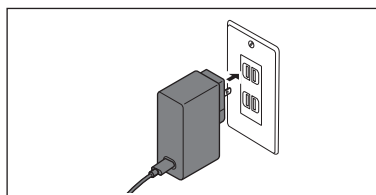
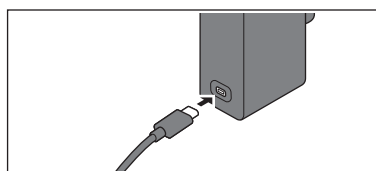
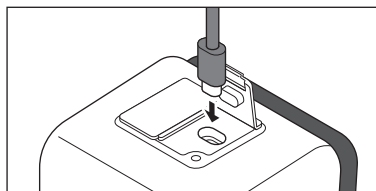

□ Turning the Power ON/OFF

Operating Procedure

Turning the Power ON

- 1 With the power OFF, press and hold the power switch for about 1 second.
The power will turn ON.

- Notes**
- When first turning the instrument ON after purchasing, the language setting screen will be displayed, followed by the date and time setting screen. Configure the settings according to [P. 114](#) and [P. 115](#).

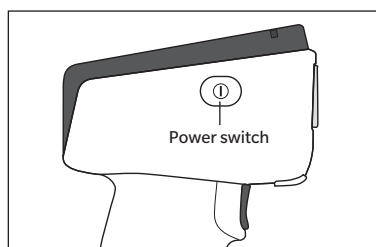

Operating Procedure

Turning the Power OFF

- 1 Press and hold the power switch for about 2 seconds.
The power will turn OFF after the settings have been saved.

Memo / Due to data protection within the instrument, powering down may take several seconds to several tens of seconds.

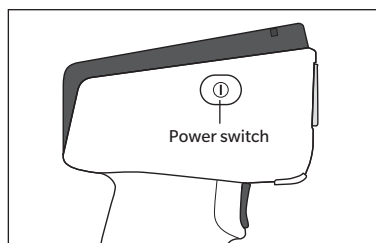

□ Measurement Area Selection (CM-17d)

Select the measurement area.

The selected measurement area can be checked on the status bar displayed on the screen. (Refer to P. 19.)

Operating Procedure

Operate the measurement area switch on the instrument.

- 1 Use the measurement area switch on the bottom of the instrument to set the measurement area to MAV or SAV.

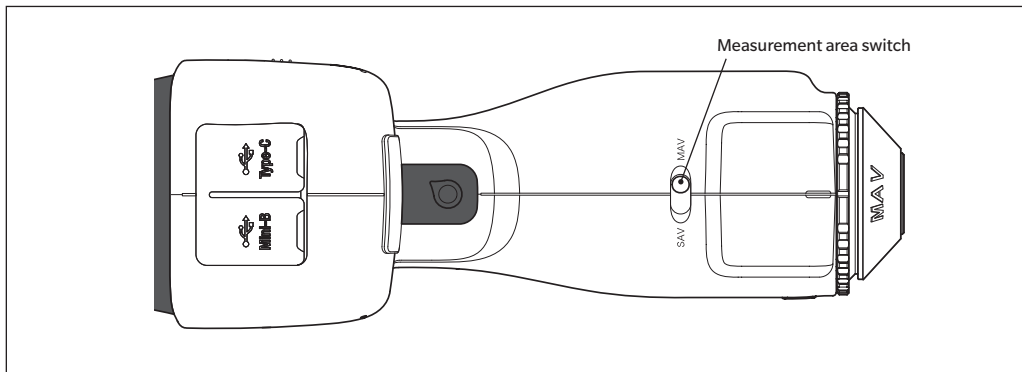

Setting

- MAV : Measurement area $\varnothing 8$ mm
- SAV : Measurement area $\varnothing 3$ mm

□ Attaching/Removing the Target Mask

The CM-17d/16d requires the attachment of an appropriate target mask according to the set measurement area and selected ambient conditions.

To attach/remove the target mask, follow the procedure given below.

Notes

- During operation, make sure that no dust or debris can enter the integrating sphere through the specimen measuring port.
- Do not touch the white-coated inner surface of the integrating sphere, wipe it with a cloth or put an object inside it.
- Fit the target mask securely so that the bottom is parallel to the instrument.
- Make sure the measurement area set for the instrument matches the diameter of the target mask being used.
- Do not apply excessive force to the latch on the inner surface of the target mask. Doing so may damage the latch and render the target mask unusable.

Memo

If the target mask is damaged, contact a KONICA MINOLTA-authorized service facility.

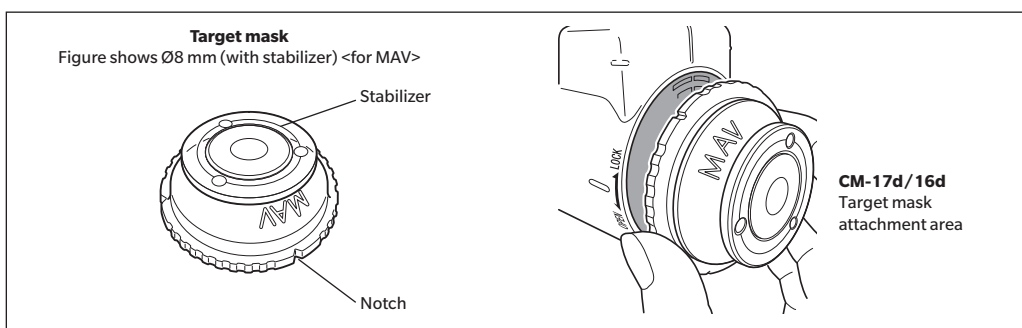

Attaching the Target Mask

- 1 The outer circumference surface of the target mask and the exterior cover should be in close contact with each other.

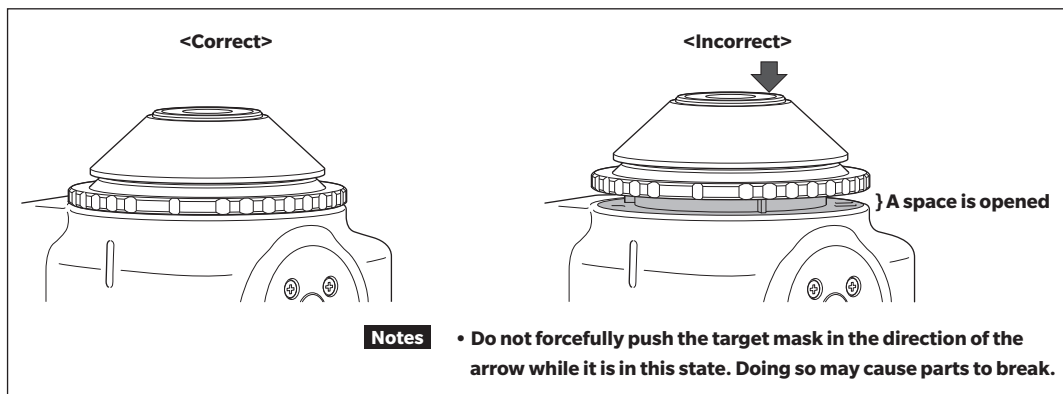

- 2 Hold the outer edge of the target mask and turn it in the direction marked LOCK (clockwise). Turn the target mask until the notch on the outer circumference aligns with the groove on the instrument cover (until a click is heard) to secure it in place.

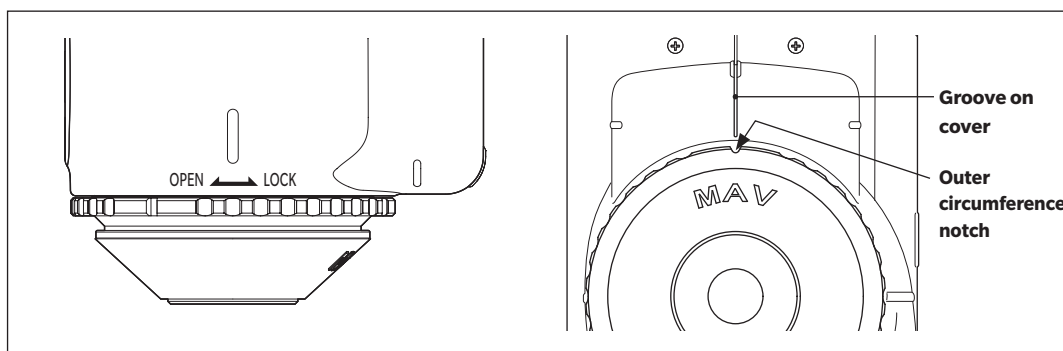

Removing the Target Mask

- 1 Hold the outer edge of the target mask and turn it in the direction marked OPEN to remove it (turn it counterclockwise until you reach the position where it stops).

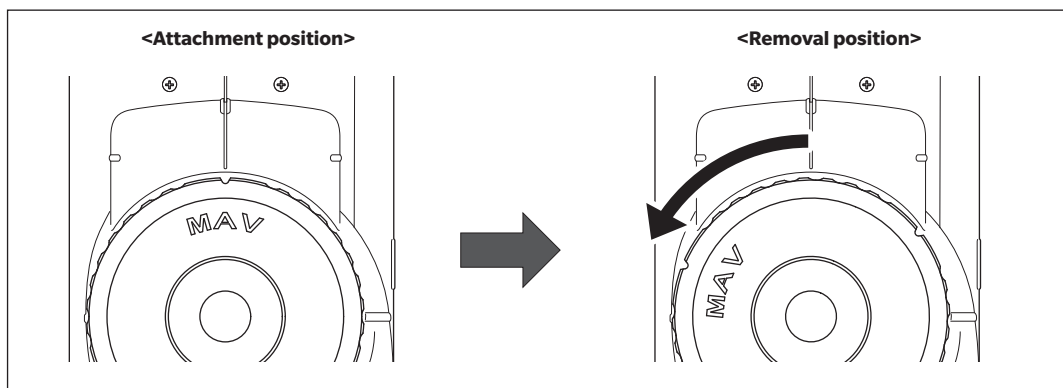

- 2 Hold the outer edge of the target mask and pull it off.

White Calibration Cap CM-A298

A white calibration cap is included with the instrument.

The white calibration cap has the structure shown in the figure below, and is attached to the instrument when performing white calibration.

- Notes**
- Make sure the white calibration cap being used includes the same production number as that of the instrument being used.
 - When the white calibration cap is not in use, keep the white calibration plate away from external light and dust by taking such measures as placing the cap pointed downward.
 - When the CM-17d/16d is not in use, be sure to attach the white calibration cap before storing to prevent dust and the like from entering the integrating sphere through the specimen measuring port.

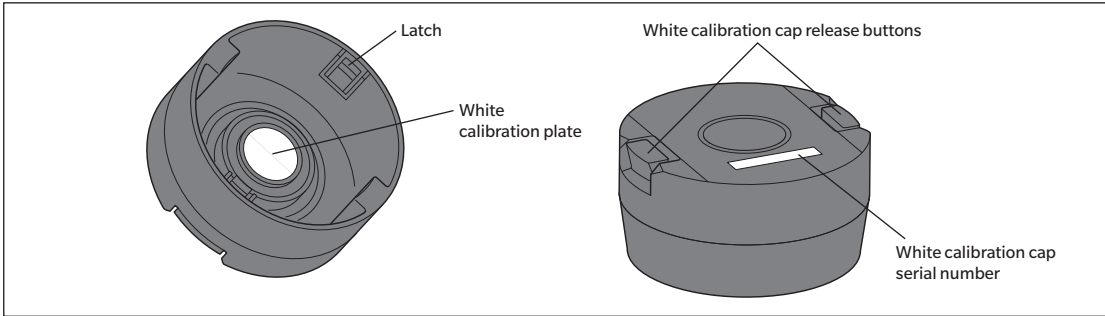

The same 8-digit serial number is inscribed on both the instrument and the white calibration cap. For white calibration, the instrument and white calibration cap with the same serial number should be used in combination.

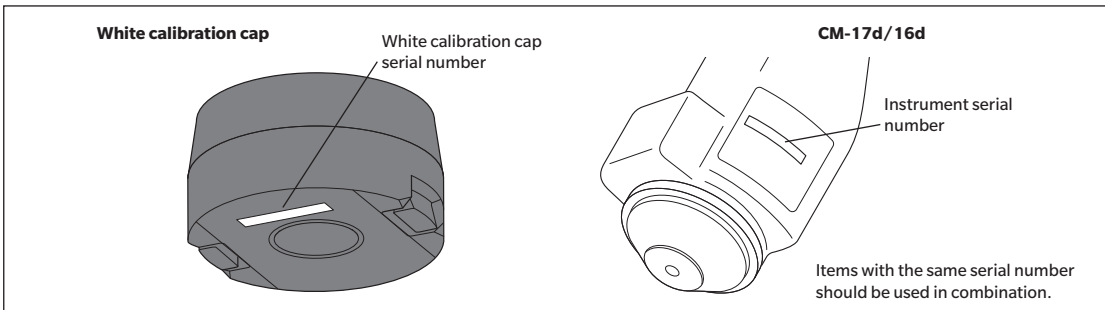

Attaching to/Removing from the Instrument

Attaching the White Calibration Cap

- 1 Hold the instrument securely.
- 2 While pressing the white calibration cap release buttons, attach the white calibration cap so that it covers the target mask of the instrument.

- Notes**
- Do not move the instrument by holding the white calibration cap attached to the instrument. Doing so may cause the instrument to become separated from the white calibration cap and fall, which may damage the instrument.

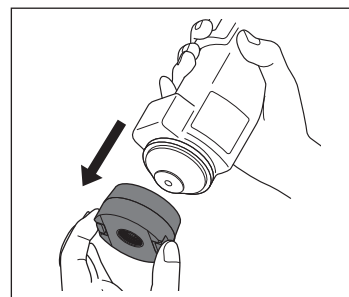
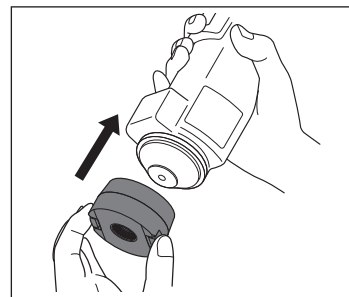

Removing the White Calibration Cap

- 1 While pressing the white calibration cap release buttons, pull the white calibration cap straight off the instrument.

Calibration

Select the measurement area using the switch beforehand.

The types of calibration performed with the instrument are zero calibration and white calibration (or user calibration).

The reflectance is measured in advance using a known calibration plate to calibrate the reflectance scale at the 0% level for zero calibration and at the 100% level for white calibration.

Zero Calibration

Since this instrument stores the data of the previous zero calibration, repeating zero calibration every time the instrument is turned ON is not necessary. If, however, the measurement conditions change greatly, the instrument is not used for a long period of time, or when using a MAV target mask (with glass), zero calibration must be performed before white calibration.

- Memo**
- The effects of stray light (i.e., light generated due to the flare characteristics of the optical system) will be compensated for automatically by the zero calibration data.
 - The amount of stray light may change because of dust or dirt that has collected in the optical system, humidity, repeated operation, or vibration and shock exerted on the instrument. In this case, performing zero calibration periodically is recommended.

- Notes**
- If the instrument is not used for long periods of time, the zero calibration data stored in the instrument may be lost. If the data is lost, zero calibration must be performed again.
 - Before using the MAV target mask (with glass), it is necessary to set “Zero cal. skippable” (P. 145) to “Disable” in advance.

Operating Procedure

Start the procedure from the measurement screen.

1 Press [MENU], and then use [◀] or [▶] to display the <Calibration> screen.

- Notes**
- The following screen prompting calibration is displayed when the instrument starts up. If zero calibration has not been performed, the cursor will appear on “Calibration (Including Zero Cal.)”. Otherwise, the cursor will appear on “Calibration (Excluding Zero Cal.)”.

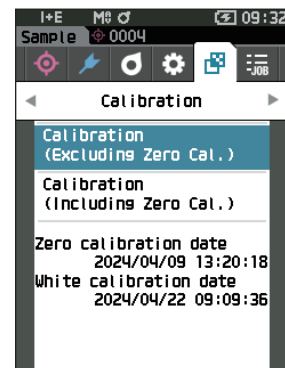

2 Use [▲] or [▼] to move the cursor to “Calibration (Including Zero Cal.)”, and then press the [Confirmation] key.

3 Set the instrument on the cradle.

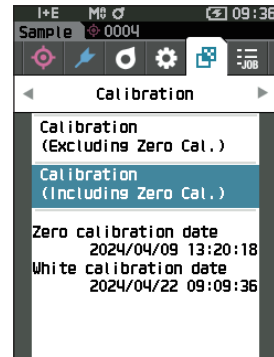
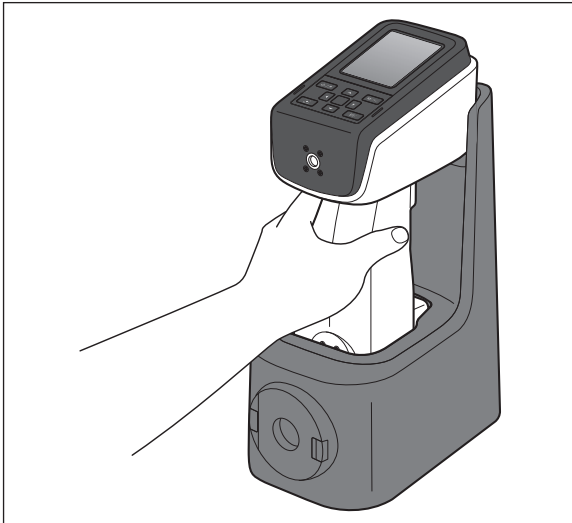

4 Press the measurement button or the [Confirmation] key.

Zero calibration will be performed.

Notes • Do not move the instrument until zero calibration is complete.

When zero calibration is completed, a screen prompting white calibration is displayed. Continue to step 3 on the following page to perform white calibration.

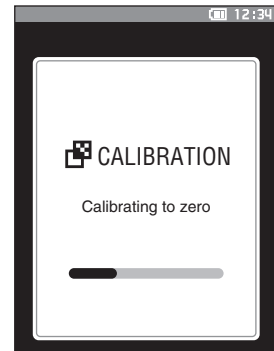

Although we recommend that zero calibration be performed using a cradle, if no cradle is available or if you do not use a cradle for calibration, such as when installing the instrument on a line, perform zero calibration as follows or use the CM-A182 zero calibration box (optional accessory) to perform zero calibration.

1 Orient the specimen measuring port on the instrument toward empty space.

- Do not direct illuminants (including lighting such as fluorescent lamps) toward the specimen measuring port.
- The specimen measuring port should be kept at least 1 m from any reflective object (such as hands, desks, and walls).

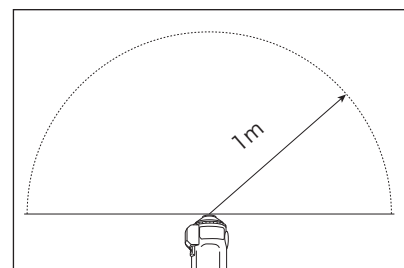

Memo Use of the cradle (CM-A299) or zero calibration box (CM-A182) ensures proper zero calibration.

White Calibration

A message prompting white calibration is displayed on the instrument after the power is turned ON.

- Memo**
- If the calibration interval is turned ON and a time is configured, a message prompting white calibration will be displayed the next time the power is turned ON or when measurement is performed after the set time has passed since the previous white calibration. (Refer to P. 142 “Calibration Interval Messages”)
 - The reading may fluctuate slightly due to changes in the ambient temperature or due to heat generation caused by repeated operation of the instrument. In such cases, perform white calibration regularly.

- Notes**
- **White calibration must be performed at the same temperature at which measurement will be performed.**
 - **Perform white calibration after the instrument has had time to adapt to the ambient temperature.**

Operating Procedure

Start the procedure from the measurement screen.

Although white calibration can be performed from the prompt when the power is turned ON and from the screen following zero calibration, the following explains the procedure to perform white calibration from the measurement screen.

- 1 Press [MENU], and then use [◀] or [▶] to display the <Calibration> screen.

- Notes**
- The following screen prompting calibration is displayed when the instrument starts up. If zero calibration has not been performed, the cursor will appear on “Calibration (Including Zero Cal.)”. Otherwise, the cursor will appear on “Calibration (Excluding Zero Cal.)”.

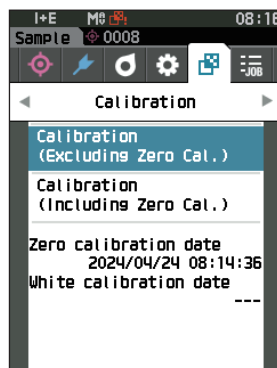

- 2 Use [▲] or [▼] to move the cursor to “Calibration (Excluding Zero Cal.)”, and then press the [Confirmation] key.

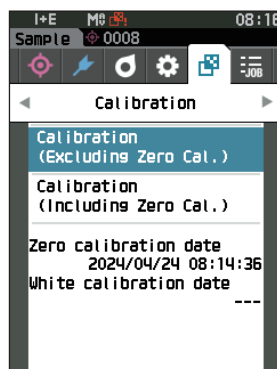

3 Correctly place the white calibration cap with the same serial number as the instrument onto the instrument.

- Notes**
- Verify that the White ID shown on the screen and the white calibration cap number match.

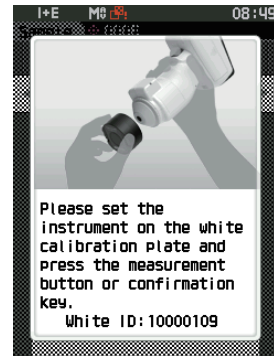
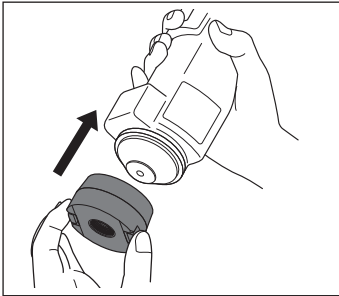

4 Press the measurement button or the [Confirmation] key.

White calibration will be performed.

- Notes**
- Do not move the instrument until white calibration is complete.

After white calibration is complete, a screen prompting to continue wavelength analysis & adjustment (WAA) will be displayed.



Calibration data will need to be written (updated) any time you purchase a new white calibration cap. Use Configuration Tool CM-CT1 to write calibration data. For details, refer to "New White Calibration Plate / Gloss Calibration Plate" in the CM-CT1 manual.

■ User Calibration

You can perform calibration by using your own reference plate and calibration data instead of white calibration. The calibration data for user calibration can be specified by connecting the instrument to a computer and using the optional Color Data Software SpectraMagic NX2. Select whether to use the user calibration data for measurement with <Calibration setup> - <User calibration> (refer to P. 144) on the instrument.

Operating Procedure

Start the procedure from the measurement screen.

1 Perform user calibration instead of white calibration.

Notes Before user calibration can be set to ON, user calibration data must be prepared and written to the instrument memory from a computer.

2 Set the instrument on the user tile so that the measuring port is over the tile.



3 Press the measurement button.

User calibration will be performed. When user calibration is completed, the screen returns to the one displayed before the <Calibration> screen.

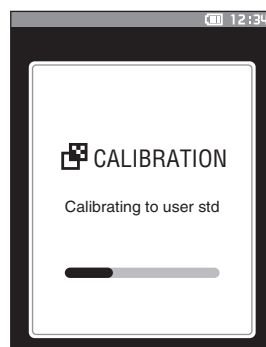

Setting a Specimen

Refer to P. 35 for preparations to perform before measurement according to the specimen being measured and the application.

1. **Switch the measurement area (CM-17d only).**
2. **Replace the target mask (CM-17d/16d).**
3. **Set the instrument on top of the specimen.**

■ Camera Viewfinder (CM-17d Only)

The camera viewfinder allows users to check the measurement point of a specimen when aligning the instrument and the target is necessary, such as when the measurement location is small.

How to Use

1. **Set the instrument on top of the specimen.**
2. **Press the [Camera Viewfinder] key  or press and hold the measurement button for at least 0.5 seconds to confirm the measurement point.**

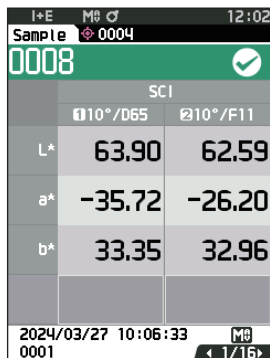

The screenshot shows the instrument's LCD screen with the following data:

SCI		
10°/D65	10°/F11	
L*	63.90	62.59
a*	-35.72	-26.20
b*	33.35	32.96

Additional information on the screen includes: Sample 0004, 0008, 2024/03/27 10:06:33, and 1/15.

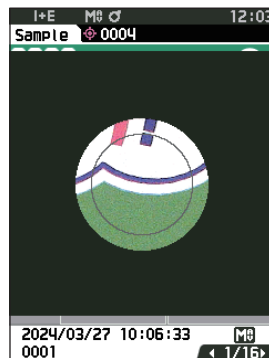

Memo When performing opacity measurement, press the  key from the Black Back / White Back screen to confirm the measurement point.

3. **When the display is switched to the camera viewfinder display, a white LED lights up to illuminate the measurement specimen.**

Memo The white LED illuminates the illumination area range according to the set measurement area (MAV/SAV). The measurement area is indicated by a gray circle on the display screen.

4. **Adjust the position of the specimen on the LCD screen.**

Measurement

Notes

- Prior to the start of measurement, be sure to perform white calibration. For details, refer to P. 40 “White Calibration”.
- To display the color difference, color difference target must be set before measurement.
- To measure a target, select the target number before measurement.
- For accurate measurements, measure under the same conditions (surrounding temperature, etc.).

Operating Procedure

1 Press [ϕ / \nearrow] to bring up the <Target> or <Sample> screen, depending on the objective.

The <Target> screen or the <Sample> screen is displayed.

Note: If the menu screen is displayed, press [ESC] and perform the operation after the Results Display screen is displayed.

	10°/D65	10°/F11
L*	63.95	62.65
a*	-35.79	-26.21
b*	33.71	33.32

2 Set the specimen measuring port on the specimen to measure.

- Take care to prevent floating or tilting from occurring.

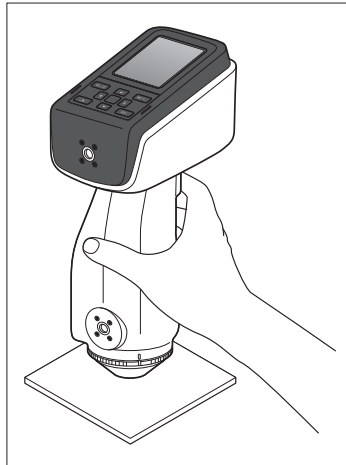
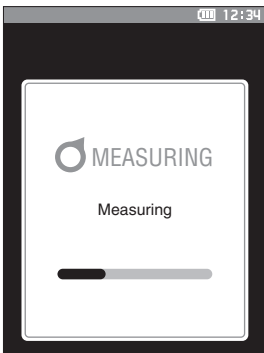

For measurement with the measuring port facing upward, use the vertical leveling jig (CM-A304).

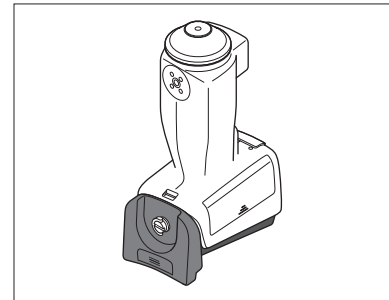

3 Press the measurement button.

The specimen is measured and the results are displayed on the screen.

- The selected number will be used as the target data number. If data is already present for that number, a confirmation dialog will ask if the data should be overwritten. Press the [Confirmation] key to overwrite.
- The sample number is automatically assigned sequentially in the order of measurements.

	10°/D65	10°/F11
ΔL*	0.15	0.17
Δa*	0.04	0.05
Δb*	0.45	0.53
ΔE*ab	0.48	0.56
HI	0.08	0.08

Memo

- When the number of sample data sets stored in the memory reaches 5,000, “The device memory is full. Please delete some data to measure.” will be displayed, indicating that some data sets must be deleted before measurement is possible.

■ Displaying the Measurement Results

At the end of measurement, the measurement results will be displayed on the LCD according to the specified conditions. Typical measurement result screens are shown below.

Memo You can switch the tab of the measurement screen with the [◀] or [▶] key.
You can switch the sample number with the [▲] or [▼] key.

□ <Sample> Detail Screen: Absolute Value

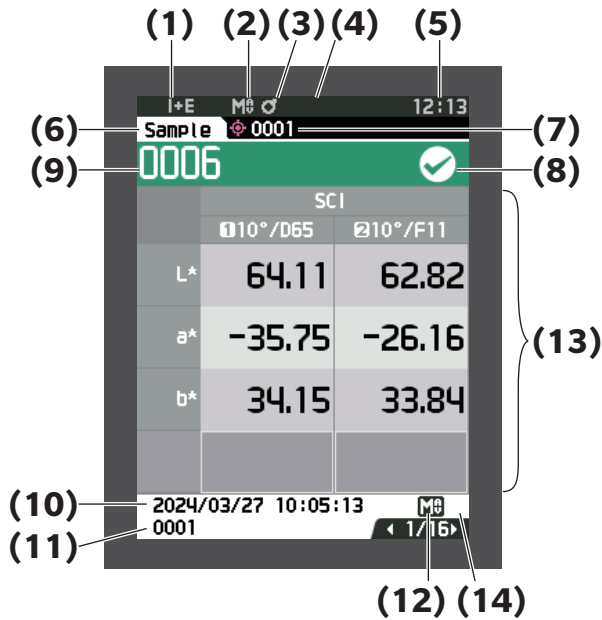

- (1) Specular component mode used for the measurement
 - (2) Current measurement area
 - (3) Calibration completed
 - (4) Automatic printing from serial printer set to ON (OFF when the icon is not displayed)
 - (5) Current time
- * For details of the status bar items (1) to (5), refer to [P. 19](#).
- (6) Target/Sample
 - (7) Currently selected color difference target data number
 - (8) Pass/fail judgment (When the result is "Pass", the background is shown in green. When the result is "Fail", the background is shown in orange.)
 - (9) Sample number
 - (10) Date and time of the measurement
 - (11) Data number of the color difference target used for the measurement
 - (12) Measurement area used for the measurement
 - (13) Sample data (Use ◀ or ▶ to switch tabs)
 - (14) An exclamation mark (ⓘ) will be displayed for measurements that are beyond the guaranteed range or when measurement is performed even though a light intensity decrease warning or measurement out-of-range warning has occurred.

☐ <Sample> Detail Screen: “Difference” Tab

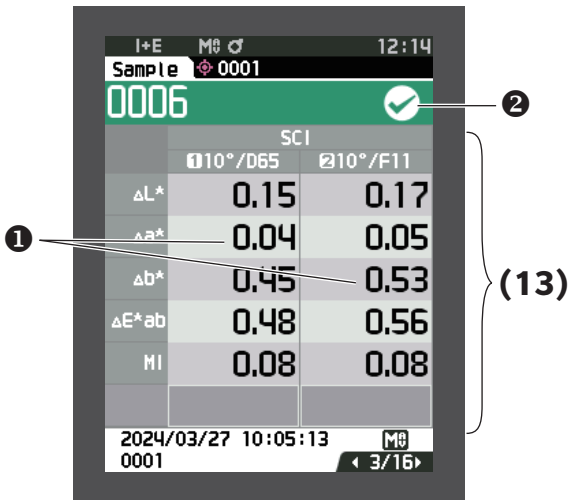

(13) Sample data

(Use ◀ or ▶ to switch tabs)

- ① Any color difference value which failed the pass/fail judgment based on the tolerance will be highlighted in red.
- ② Pass/Fail:
 - Pass: The background is shown in green and “✓” is displayed.
 - Warning: The background is shown in yellow and “✓” is displayed as the result nears “Fail”.
 - Fail: The background is shown in orange and “x” is displayed.

☐ <Sample> Detail Screen: “Abs. & Diff.” Tab

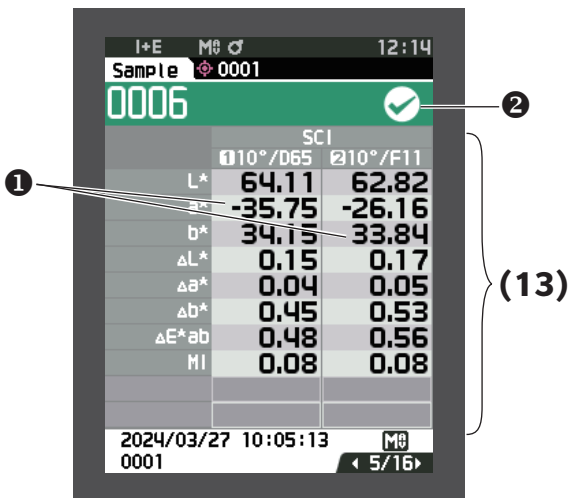

(13) Sample data

(Use ◀ or ▶ to switch tabs)

- The left side shows the sample data measured with illuminant 1, and the right side shows the sample data measured with illuminant 2. If illuminant 2 has not been set, the right side will be blank.
- ① Any color difference value which failed the pass/fail judgment based on the tolerance will be highlighted in red.
 - ② Pass/Fail:
 - Pass: The background is shown in green and “✓” is displayed.
 - Warning: The background is shown in yellow and “✓” is displayed as the result nears “Fail”.
 - Fail: The background is shown in orange and “x” is displayed.

☐ <Sample> Detail Screen: “Pass/Fail” Tab



Pass/Fail:

- Pass: The background is shown in green and “✓ Pass” is displayed.
- Warning: The background is shown in yellow and “✓ Warning” is displayed as the result nears “Fail”.
- Fail: The background is shown in orange and “× Fail” is displayed.

☐ <Sample> Detail Screen: “Custom” Tab

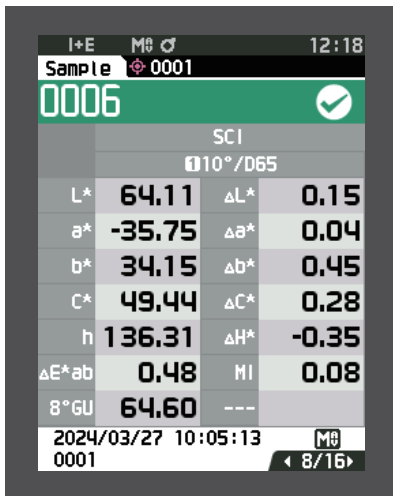

(13) Sample data

(Use ◀ or ▶ to switch tabs)

- This tab is displayed when the “Custom” display setting is ON. For the procedure for configuring the “Custom” display setting ON/OFF, refer to P. 94.

Memo/ To set the items displayed on the “Custom” screen, you need to use the optional Color Data Software SpectraMagic NX2. For details, refer to the instruction manual of SpectraMagic NX2.

☐ <Sample> Detail Screen: “Abs. Graph” Tab

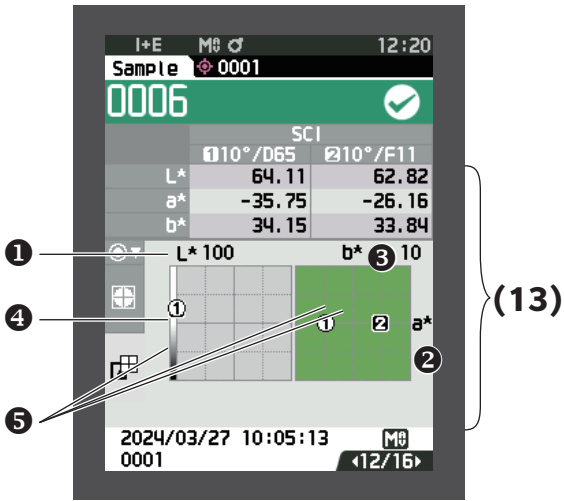

- (13) Sample data
(Use ◀ or ▶ to switch tabs)
- ① L* axis (colorimetric graph)
 - ② a* axis (colorimetric graph)
 - ③ b* axis (colorimetric graph)
 - ④ Scales for the axes
 - ⑤ Measurement point

☐ <Sample> Detail Screen: “Diff. Graph” Tab

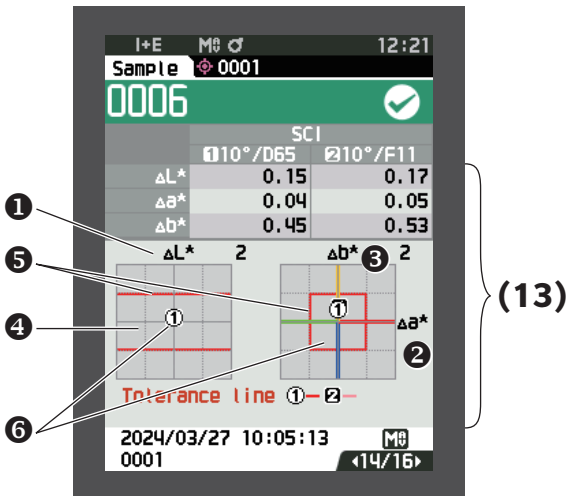

- (13) Sample data
(Use ◀ or ▶ to switch tabs)
- ① ΔL^* axis (color difference graph)
 - ② Δa^* axis (color difference graph)
 - ③ Δb^* axis (color difference graph)
 - ④ Color difference tolerance
 - ⑤ Measurement point: Plotted with a light-blue circle (○).
 - ⑥ Color difference target measurement point: This is the origin point of the graph.

Notes The measuring point will not be shown on the graph when no color difference target is set for the sample data.

☐ <Sample> Detail Screen: “Spectral Graph” Tab

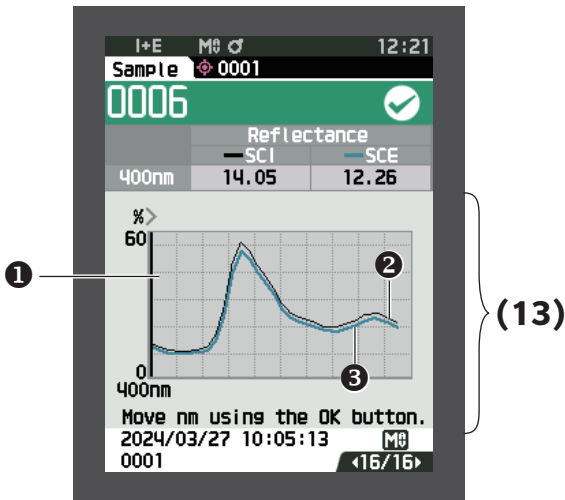

(13) Sample data

(Use ◀ or ▶ to switch tabs)

- ① Axis of spectral reflectance
- ② Spectral graph of sample (SCI):
Shown with a solid black line.
- ③ Spectral graph of sample (SCE):
Shown with a solid light blue line.

☐ <Sample> List Screen

Every time the [ESC] key is pressed, the screen is switched between the <Sample> detail screen and <Sample> list screen.

Memo / Measurement can be performed on either the <Sample> detail screen or <Sample> list screen.

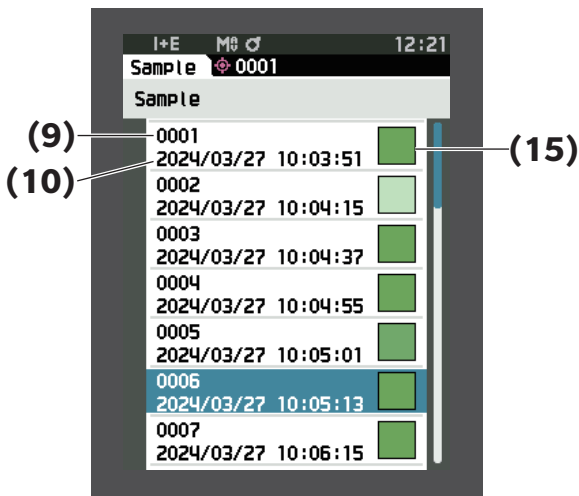

(9) Sample number

(10) Date and time of the measurement

(15) Pseudocolor expressing the sample data is displayed.

Screen transition

The detail screen is displayed only for screens with the appropriate format selected under <Display type>.

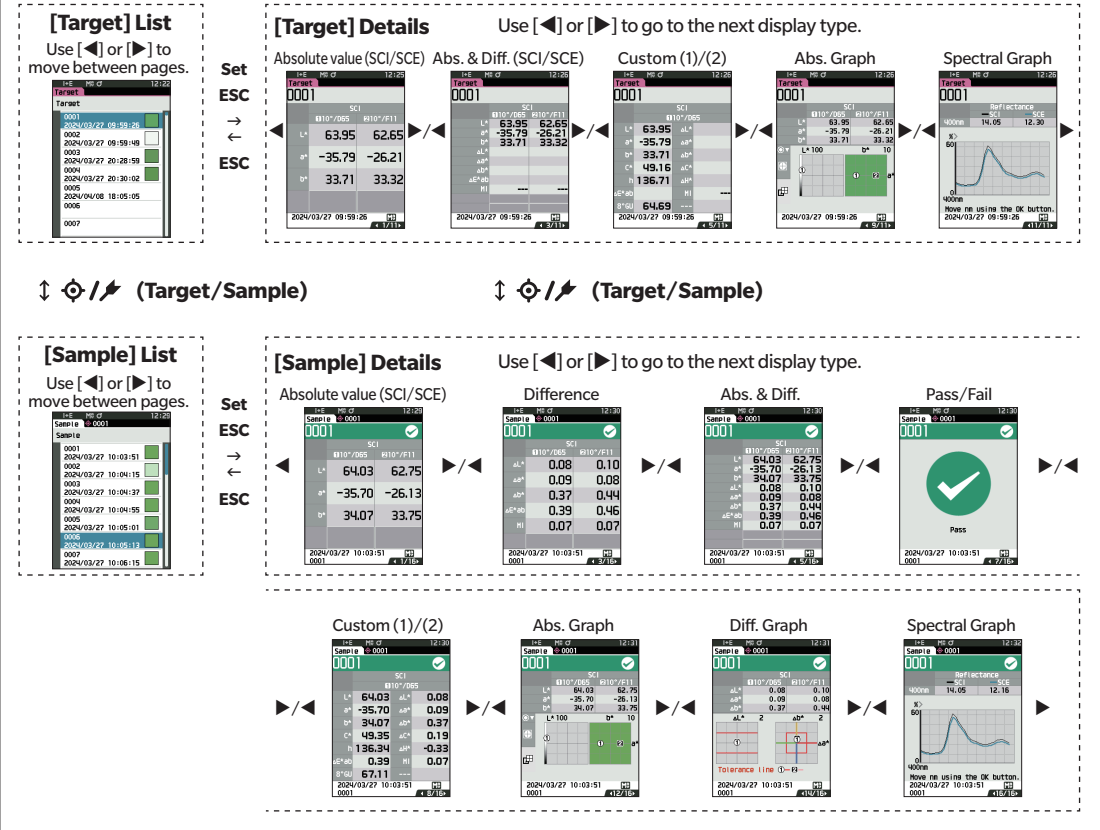

Measurement (Simple Mode)

Used to easily confirm color differences. The menu items that can be set in Simple mode are as follows.

Setting Procedure

1 Set to Simple mode.

Press [ESC] to skip the calibration displayed immediately after turning the power ON.

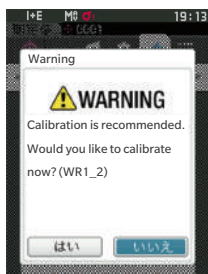
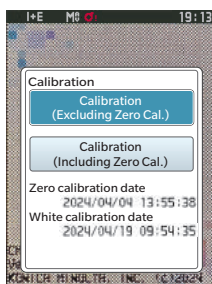

When "Change to simple mode?" appears on the screen, select "Yes".

Set "Simple" under <Setting> - <Instrument Mode>.

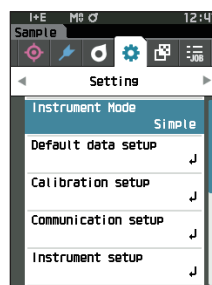

Press the [Target/Sample] button or the [ESC] button to switch to the simple measurement screen.

2 Measuring a target: Absolute value measurement

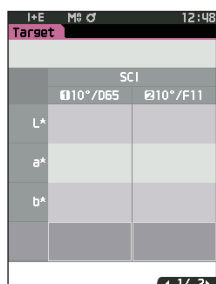

Press the measurement button.



3 Measuring a sample: Color difference measurement

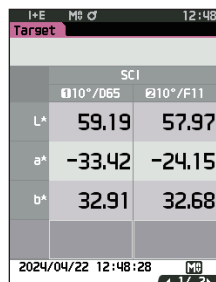

Press the measurement button.

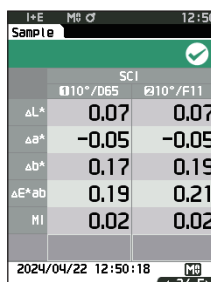

Notes

- Data is not saved when measuring in Simple mode.
- Opacity mode cannot be selected while in Simple mode. In addition, Simple mode cannot be selected while in Opacity mode.

- 4 Press the measurement button to continue measuring color differences. To change the target, press [Target/Sample] to measure the target again.

Memo To exit Simple mode, turn the instrument OFF or select “Normal” under [MENU] - <Setting> - <Instrument Mode>.

Handling the Sample

The <Sample menu> screen allows the following operations for the sample.

<Print data> Print the current sample with the printer.

<Edit name> Name the sample.

<Data management>

- Delete data : Delete the selected sample.
- Set Sample as Target : Set sample as target data.
- Change Target reference : Change target reference.
- Change list position : Jump to the specified sample.
- Delete all data : Delete all samples.

<Auto Target> During measurement, the color difference target with the smallest color difference value is automatically selected.

Setting Procedure

Start the procedure from the measurement screen.

1 Press [MENU], and then use [◀] or [▶] to display the <Sample menu> screen.

Memo To return to the previous screen, press [MENU] or [ESC].



Print Data (Sample)

Print the sample. The instrument must be connected to the serial printer in advance. For instructions on how to connect the instrument to a serial printer, refer to P. 135 “Connecting to a Printer”.

- Notes**
- Display the sample to be printed on the <Sample> screen in advance.
 - If a proper connection is not established, printing will not be possible.
 - Even if the printer is connected correctly, printing may not be possible under some circumstances, such as if the printer is turned OFF when printing.

Display the sample to be printed on the <Sample> screen in advance.

Setting Procedure

Start the procedure from the <Sample menu> screen.

- 1 Use [▲] or [▼] to move the cursor to “Print data”, and press the [Confirmation] key to display the <Print data> screen. Printing will begin from the connected printer.

When printing is complete, the screen returns to the <Sample> screen.

- Notes** The <Print data> screen is displayed even when data will not be printed properly due to an improper printer connection or other problem.



■ Edit Name

Name the sample.

Display the sample whose name is to be edited on the <Sample> screen in advance.

Setting Procedure

Start the procedure from the <Sample menu> screen.

- 1 Use [▲] or [▼] to move the cursor to “Edit name”, and then press the [Confirmation] key.

The <Edit name> screen is displayed.

- 2 Use [▲]/[▼] or [◀]/[▶] to move the cursor between characters, and then press the [Confirmation] key.

- Up to 30 characters can be used.
- The selected character is displayed in the text box.
- If the name is obtained from the barcode reader, that name will be set as the name for the sample.

- 3 Repeat step 2 until the necessary characters have been entered.

- To delete the character to the left of the cursor in the text box, move the cursor to [×] and press the [Confirmation] key.

- 4 After inputting the characters, move the cursor to “OK” and press the [Confirmation] key.

The setting is confirmed and the screen returns to the <Sample> screen.

Memo

- If [ESC] is pressed during configuration, or if the cursor is moved to “Cancel” and the [Confirmation] key is pressed, the settings will not be changed and the screen will return to the <Sample menu> screen.
- When using a barcode reader, barcodes can be used on the <Edit name> screen. Refer to P. 103 to 105 “Connecting to a Printer/Barcode Reader” for information on connecting a barcode reader.

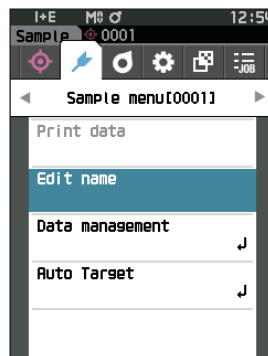

Data Management (Sample)

Sample data management allows users to delete a sample, copy the sample to the target, change the link to the target, change the list position, and delete all data.

Setting Procedure

Start the procedure from the <Sample menu> screen.

- Use [▲] or [▼] to move the cursor to “Data management”, and then press the [Confirmation] key to display the <Data management> screen.

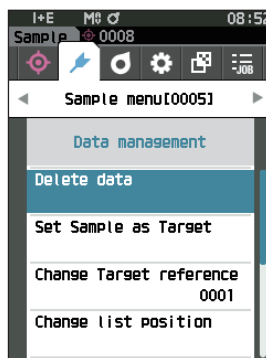
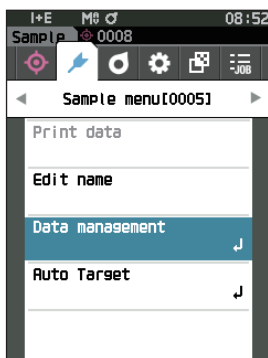

Delete

Delete the sample.

Display the sample to be deleted on the <Sample> screen in advance.

Setting Procedure

Start the procedure from the <Sample menu> - <Data management> screen.

- Use [▲] or [▼] to move the cursor to “Delete data”, and then press the [Confirmation] key.
The <Delete data> screen is displayed.
- Use [◀] or [▶] to move the cursor to “OK” and press the [Confirmation] key to delete.

Memo When data is deleted, the subsequent sample data numbers will be reassigned, reducing each by one.

- When the deletion is complete, the screen returns to the <Sample> screen.
- Moving the cursor to “Cancel” and pressing the [Confirmation] key will cancel the deletion, and the screen will return to the <Data management> screen.

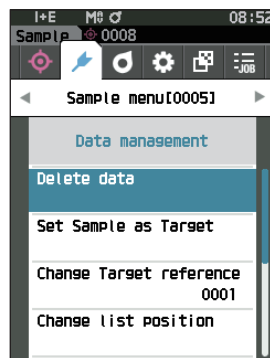

□ Set Sample as Target

Sample data can be copied to target data and registered.
Display the sample to be set as the target on the <Sample> screen in advance.

Setting Procedure

Start the procedure from the <Sample menu> - <Data management> screen.

- Memo**
- Color difference targets are stored with setting numbers from 0001 to 2500 being assigned. Even if the data at some point is deleted, these setting numbers do not change. It is useful to group data by assigning numbers of specific digits.
 - To set more accurate color difference target data, use average measurement to measure the target specimen. For details, refer to the section on average measurement (P. 97 and 98).

- Notes**
- **Unlike with samples, the numbers assigned to color difference target data do not change automatically. When measuring colors continuously to set color difference targets, the cursor must be moved manually to set each data.**
 - This function cannot be used if the target is protected or if the filter is enabled.

1 Use [▲] or [▼] to move the cursor to “Set Sample as Target”, and then press the [Confirmation] key.

The <Set Sample as Target> screen is displayed.

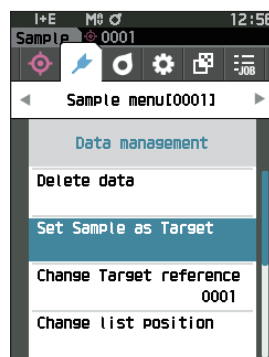

2 The target data number being used will be displayed. Use [▲] or [▼] to move the cursor to the color difference target number, and then press the [Confirmation] key. When the target data is set, the screen returns to the <Target> screen.

- If [ESC] is pressed without pressing the [Confirmation] key, the screen will return to the <Target> screen.

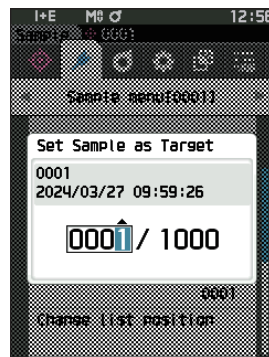

- Notes**
- If a number to which color difference target data has already been set is selected, a message is displayed to confirm overwriting. Use [◀] or [▶] to select “OK”. Moving the cursor to “Cancel” and pressing the [Confirmation] key will cancel the deletion, and the screen will return to the <Set Sample as Target> screen.



□ Change Target Reference

The target data acting as a reference for the sample can be changed.

Display the sample for which the target reference is to be changed on the <Sample> screen in advance.

Setting Procedure

Start the procedure from the <Sample menu> - <Data management> screen.

- 1 Use [▲] or [▼] to move the cursor to “Change Target reference”, and then press the [Confirmation] key.

The <Change Target reference> screen is displayed.

- Notes**
- If a target with different measurement conditions is specified, an error message will be displayed. Change to a target with the same measurement conditions.

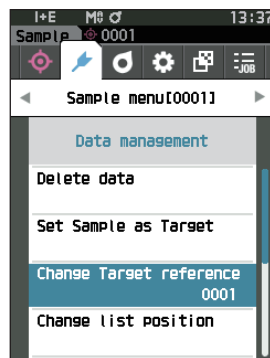

- 2 The target data number being used will be displayed. Use [▲] or [▼] to move the cursor to the color difference target number, and then press the [Confirmation] key. When the target data is set, the screen returns to the <Sample> screen.

- If [ESC] is pressed, the target changes will not be applied and the screen will return to the <Data management> screen.

- Notes**
- If a number to which no color difference target data has been set, the target will be determined as “None” and the color difference and pass/fail judgment will not be displayed.

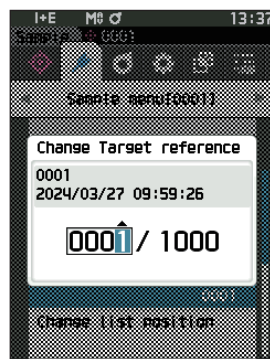

□ Change List Position

Specifying a sample number allows the specified sample to be selected without the need to scroll the screen.

Setting Procedure

Start the procedure from the <Sample menu> - <Data management> screen.

- 1 Use [▲] or [▼] to move the cursor to “Change list position”, and then press the [Confirmation] key.
The <Change list position> screen is displayed.

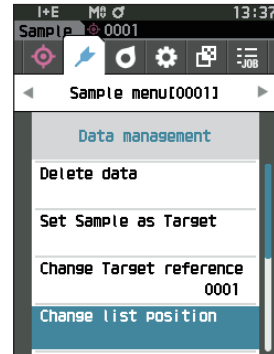

- 2 ▲ and ▼ will be displayed above and below the data number. Use [▲] or [▼] to specify a value. Use [◀] or [▶] to move between digits.

- 3 Press the [Confirmation] key.

The selection is confirmed and the screen returns to the <Sample> screen.

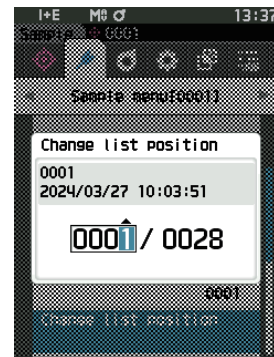

Notes If [ESC] is pressed without pressing the [Confirmation] key, the settings will not be changed and the screen will return to the <Data management> screen.

Notes Numbers with no measurement data cannot be selected.

□ Delete All Data (Sample)

Delete all samples.

Setting Procedure

Start the procedure from the <Sample menu> - <Data management> screen.

- 1 Use [▲] or [▼] to move the cursor to “Delete all data”, and then press the [Confirmation] key.

The <Delete all data> screen is displayed.



- 2 Use [◀] or [▶] to move the cursor to “OK” and press the [Confirmation] key to delete all data.

- When the deletion is complete, the screen returns to the <Sample> screen.
- Moving the cursor to “Cancel” and pressing the [Confirmation] key will cancel the deletion of all data, and the screen will return to the <Data management> screen.



■ Auto Target (Sample)

During measurement, the color difference target with the smallest color difference value is automatically selected. Color difference targets with a smaller color difference value than the preset threshold are displayed in ascending order from the target with the smallest color difference. The color difference target to use can be selected from among the displayed targets. If only one color difference target has a color difference value less than the threshold, that color difference target will be automatically selected.

Memo The color difference is calculated using the color difference equation set for the instrument.

- Notes**
- Do not use this function to manage the color difference from a specific target.
 - This function is not applied to sample data obtained before the function was turned ON.

Setting Procedure

Start the procedure from the <Sample menu> screen.

- 1 Use [▲] or [▼] to move the cursor to “Auto Target”, and then press the [Confirmation] key to display the <Auto Target> screen.

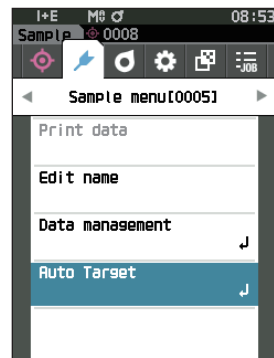

□ Auto Target (Sample)

Setting Procedure

Start the procedure from the <Sample menu> - <Auto Target> screen.

- 1 Use [▲] or [▼] to move the cursor to “Auto Target”, and then press the [Confirmation] key. The <Auto Target> screen is displayed.



2 Use [▲] or [▼] to move the cursor to “ON” or “OFF”.

Settings

- ON : The automatic target selection function will be used.
- OFF : The automatic target selection function will not be used.

3 Press the [Confirmation] key.

The selection is confirmed and the screen returns to the <Auto Target> screen.



□ Threshold (Sample)

Sets the threshold to be used for the automatic target selection function.

Setting Procedure

Start the procedure from the <Sample menu> - <Auto Target> screen.

1 Use [▲] or [▼] to move the cursor to “Threshold”, and then press the [Confirmation] key.

The <Threshold> screen is displayed.



2 ▲ and ▼ are displayed above and below the number to be set.

Use [▲] or [▼] to specify a value.

Settings

- 0.01 to 9.99

3 Press the [Confirmation] key.

The selection is confirmed and the screen returns to the <Auto Target> screen.



Notes If [ESC] is pressed without pressing the [Confirmation] key, the settings will not be changed and the screen will return to the <Auto Target> screen.

Pass/Fail Judgment for Color Difference

With this instrument, tolerances can be set for the color difference target of the sample to perform judgment. For the procedure on setting tolerances, refer to [P. 75](#) "Tolerance Settings" and [P. 84](#) "Default Tolerance Settings".

If color difference target data is deleted, neither the color difference display for the data nor the pass/fail judgment based on the tolerances set to the data will be performed. If other color difference target data is selected, or another color difference target is assigned to the color difference target number of the deleted data, recalculations and pass/fail judgments will be performed.

■ Pass/Fail Judgment Based on Tolerances

If the measured color difference is outside the tolerances set for the color difference target, the value will be highlighted in red to indicate that the judgment result is "Fail". By setting the warning level (P. 63), even if the sample does not exceed the tolerance, that item will be highlighted with the warning color and a warning will be issued if the sample nears the tolerance. Both maximum and minimum tolerances can be set for each color difference target.

Pass/fail judgments based on tolerances are displayed as follows.

Notes Before using this function, the tolerances must be set.

<Sample> display screen

Notes If no relevant target data has been set, no color difference value or pass/fail mark will be displayed.

○ Display when all color differences do not exceed or near the tolerance

Absolute value, Difference, Abs. & Diff., and Custom screens

Ex.: Abs. & Diff. screen

	10°/D65	210°/F11
L*	64.03	62.75
a*	-35.70	-26.13
b*	34.07	33.75
ΔL*	0.08	0.10
Δa*	0.09	0.08
Δb*	0.37	0.44
ΔE*ab	0.39	0.46
HI	0.07	0.07

← Mark signifying a "Pass" judgment

"PASS" is printed in the print output.

Pass/Fail screen

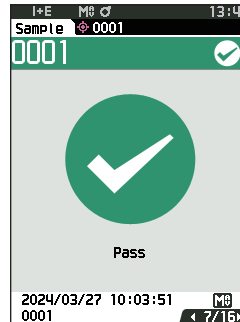

The pass mark and "Pass" are displayed.

○ Display when any color difference nears the tolerance

Absolute value, Difference, Abs. & Diff., and Custom screens

Ex.: Abs. & Diff. screen

	10°/D65	210°/F11
L*	25.86	27.18
a*	16.38	15.82
b*	19.38	21.75
ΔL*	-0.05	-0.02
Δa*	0.29	0.24
Δb*	0.71	0.78
ΔE*ab	0.77	0.82
HI	0.09	0.09

← The pass judgment mark and the background color are changed to yellow.

← The background of any value close to the tolerance is changed to yellow.

"WARN" is printed in the print output, and "w" is appended after any value near the tolerance.

Pass/Fail screen

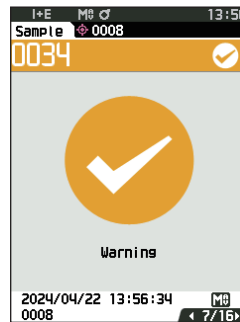

"Warning" is displayed, and the mark changes to yellow.

○ Display when any color difference exceeds the tolerance

Absolute value, Difference, Abs. & Diff., and Custom screens

Ex.: Abs. & Diff. screen

	10°/D65	210°/F11
L*	66.38	65.27
a*	-31.39	-22.92
b*	29.77	29.41
ΔL*	2.43	2.62
Δa*	4.39	3.29
Δb*	-3.94	-3.91
ΔE*ab	6.38	5.74
HI	1.12	1.12

← The fail judgment mark and the background color are changed to orange.

← The background of any value that exceeds the tolerance is changed to orange.

"FAIL" is printed in the print output, and "x" is appended after any value that exceeds the tolerance.

Pass/Fail screen

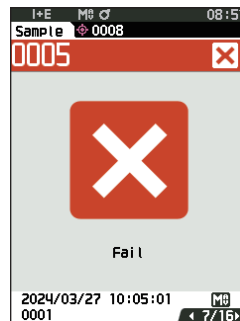

An orange fail mark and "Fail" are displayed.

Color Difference Target Operation

To measure the color difference between two specimens, the color of one of the specimens must be set as the color difference target. This instrument can store up to 1,000 targets and 5,000 samples.

- Memo**
- Color difference target data is stored with setting numbers from 0001 to 1000 being assigned. Even if the data at some point is deleted, these setting numbers do not change. It is useful to group data by assigning numbers of specific digits.
 - To set more accurate color difference target data, use average measurement to measure the target specimen. For details, refer to the section on average measurement (P. 97 and 98).

- Notes**
- **Be sure to perform white calibration before setting color difference targets.**
 - **To ensure measurement accuracy, make sure to keep ambient conditions (temperature, etc.) constant.**

The **<Target menu>** screen allows the following operations for target data.

<Print data>

Print the current target data with the printer.

<Edit name>

Name the target data.

<Data management>

- Delete data : Delete the selected target data.
- Set group : Configure the target group.
- Change list position : Jump to the specified target data.
- Edit Target filter : Display the target data that meets the specified conditions.
- Protect data : Protect all target data. New measurements are still possible.
- Delete all data : Delete all of the target data.

<Input Colorimetric data>

Set the target data by numerical input.

Operating Procedure

Start the procedure from the measurement screen.

- 1 Press [MENU], and then use [◀] or [▶] to display the **<Target menu>** screen.

- Memo** To return to the **previous screen**, press [MENU] or [ESC].



Print Data (Target)

Print the target data. The instrument must be connected to the serial printer in advance. For instructions on how to connect the instrument to a serial printer, refer to P. 135 “Connecting to a Printer”.

- Notes**
- Display the target to be printed on the <Target> screen in advance.
 - If a proper connection is not established, printing will not be possible.
 - Even if the printer is connected correctly, printing may not be possible under some circumstances, such as if the printer is turned OFF when printing.

Operating Procedure

Start the procedure from the <Target menu> screen.

- 1 Use [▲] or [▼] to move the cursor to “Print data”, and press the [Confirmation] key to display the <Print data> screen. Printing will begin from the connected printer.

When the printing is complete, the screen returns to the <Target> screen.

- Notes** The <Print data> screen is displayed even when data will not be printed properly due to an improper printer connection or other problem.



■ Edit Name

Name the color difference target data.

Operating Procedure

Start the procedure from the <Target menu> screen.

- 1 Use [▲] or [▼] to move the cursor to “Edit name”, and then press the [Confirmation] key.

The <Edit name> screen is displayed.

- 2 Use [▲]/[▼] or [◀]/[▶] to move the cursor between characters, and then press the [Confirmation] key.

- Up to 30 characters can be used.
- The selected character is displayed in the text box.

- 3 Repeat step 2 until the necessary characters have been entered.

- To delete the character to the left of the cursor in the text box, move the cursor to [×] and press the [Confirmation] key.

- 4 After inputting the characters, move the cursor to “OK” and press the [Confirmation] key.

The setting is confirmed and the screen returns to the <Target> screen.

- Memo**
- If [ESC] is pressed during configuration, or if the cursor is moved to “Cancel” and the [Confirmation] key is pressed, the settings will not be changed and the screen will return to the <Target menu> screen.
 - When using a barcode reader, barcodes can be used on the <Edit name> screen. Refer to P. 103 to 105 “Connecting to a Printer/Barcode Reader” for information on connecting a barcode reader.

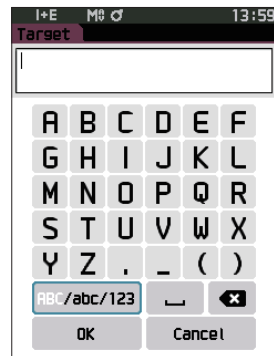
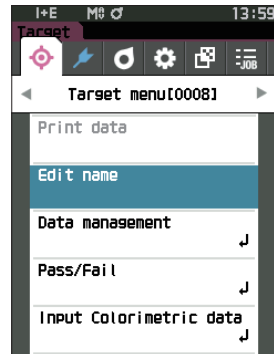

■ Data management (Target)

Target data management allows users to enforce target data restrictions, perform grouping, change list positions, edit target filters, protect data, and delete all data.

Operating Procedure

Start the procedure from the <Target menu> screen.

- 1 Use [▲] or [▼] to move the cursor to “Data management”, and then press the [Confirmation] key to display the <Data management> screen.

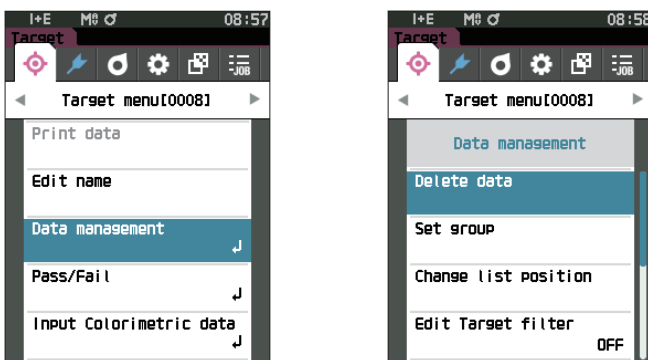

□ Delete

Delete the target data.

Display the target to be deleted on the <Target> screen in advance.

Operating Procedure

Start the procedure from the <Target menu> - <Data management> screen.

- 1 Use [▲] or [▼] to move the cursor to “Delete data”, and then press the [Confirmation] key.

The <Delete data> screen is displayed.

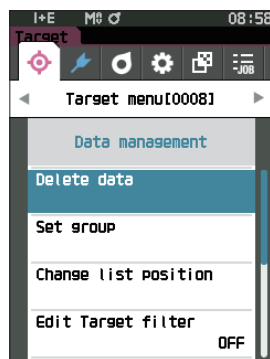

- 2 Use [◀] or [▶] to move the cursor to “OK” and press the [Confirmation] key to delete.

Memo Even if deletion is performed, numbers do not shift upward. That number for that measurement is instead left blank.

- When the deletion is complete, the screen returns to the <Target> screen.
- Moving the cursor to “Cancel” and pressing the [Confirmation] key will cancel the deletion, and the screen will return to the <Data management> screen.



□ Set Group

In order to facilitate classification of targets into groups, up to five groups to which data should be categorized can be configured. After the targets have been registered to a group, the filtering function can be used to display only the selected target data. This section describes the registration of a group.

- Memo**
- If a new target is measured, the measurement will be assigned to the appropriate group according to the default settings.
 - Display the group of the target to be set on the <Target> screen in advance.

Operating Procedure

Start the procedure from the <Target menu> - <Data management> screen.

- 1 Use [▲] or [▼] to move the cursor to “Set group”, and then press the [Confirmation] key.

The <Edit group> screen is displayed.

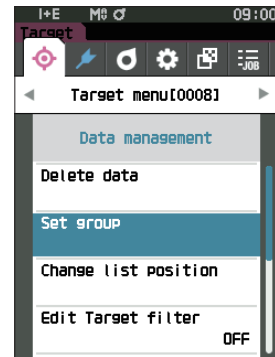

- 2 Use [▲] or [▼] to move to the cursor to the group number column to which the current target should be applied, and then press the [Confirmation] key.

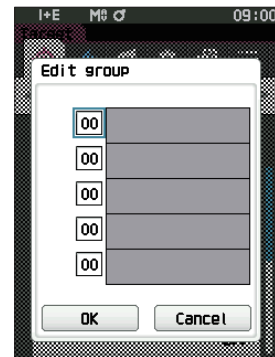

- 3 Use [▲] or [▼] to move the cursor to select the group value to which the target should be applied, and then press the [Confirmation] key.

The selection is confirmed and the screen returns to the <Target> screen.

- Memo** Group names configured in advance through <Default data setup> in accordance with group numbers are displayed.

- 4 Select “OK”. Selecting “Cancel” will cause the display to return to the <Data management> screen without changing the settings.

- Notes** If [ESC] is pressed without pressing the [Confirmation] key, the settings will not be changed and the screen will return to the <Data management> screen.

□ Change List Position

Specifying a target number allows the specified target to be displayed without the need to scroll the screen.

Operating Procedure

Start the procedure from the <Target menu> - <Data management> screen.

- 1 Use [▲] or [▼] to move the cursor to “Change list position”, and then press the [Confirmation] key.

The <Change list position> screen is displayed.

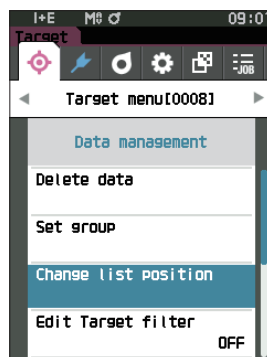

- 2 ▲ and ▼ will be displayed above and below the data number. Use [▲] or [▼] to specify a value. Use [◀] or [▶] to move between digits.



- 3 Press the [Confirmation] key.

The selection is confirmed and the screen returns to the <Target> screen.

Notes If [ESC] is pressed without pressing the [Confirmation] key, the settings will not be changed and the screen will return to the <Data management> screen.

□ Edit Target Filter

The filter function makes searching for a target easier. The function allows only selected target data to be displayed by selecting only saved data or by selecting a group created in advance.

Memo The Edit Target filter is set to “OFF” when the instrument is shipped from the factory.

Operating Procedure

Start the procedure from the <Target menu> - <Data management> screen.

1 Use [▲] or [▼] to move the cursor to “Edit Target filter”, and then press the [Confirmation] key.

The <Edit Target filter> screen is displayed.

2 Use [▲] or [▼] to move the cursor to the desired item.

Settings

- OFF : All target data will be displayed.
- only saved data : Only numbers for the saved target will be displayed.
- only group : Only targets that satisfy all of the group conditions displayed below will be displayed. Select and press the **[Confirmation] key** to display the group selection screen. With the cursor on the group numbers, press the **[Confirmation] key**. Using **[▲] or [▼]** to select the group number displays the group name set for the default group. Confirm with the **[Confirmation] key, move to [OK], and press the [Confirmation]** to return to the <Target> screen.

3 Press the [Confirmation] key. (With [OFF] and [only saved data])

The selection is confirmed and the screen returns to the <Target> screen.

Notes If [ESC] is pressed without pressing the [Confirmation] key, the settings will not be changed and the screen will return to the <Data management> screen.

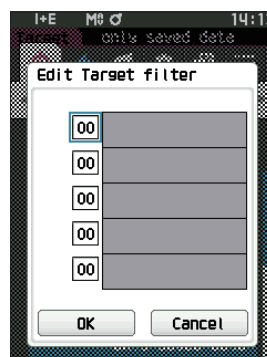
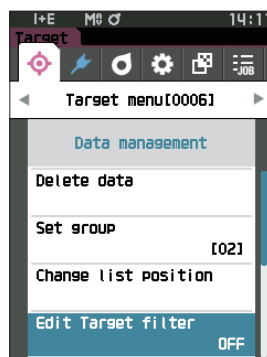

□ Data Protection

Data protection can be specified so that the saved target settings will not be deleted or changed by accident. When the data protection is set, some menu options relating to the target cannot be selected, and target overwrite measurement cannot be performed.

Memo Protect data is set to “OFF” when the instrument is shipped from the factory.

Operating Procedure

Start the procedure from the <Target menu> - <Data management> screen.

- 1 Use [▲] or [▼] to move the cursor to “Protect data”, and then press the [Confirmation] key.

The <Protect data> screen is displayed.

- 2 Use [▲] or [▼] to move the cursor to the desired item.

Settings

- OFF : Do not protect any data.
- ON : Protect all data.

- 3 Press the [Confirmation] key.

The selection is confirmed and the screen returns to the <Data management> screen. When protection is turned ON, the key icon indicating data protection is turned ON will be displayed in the status bar.

Notes If [ESC] is pressed without pressing the [Confirmation] key, the settings will not be changed and the screen will return to the <Data management> screen.

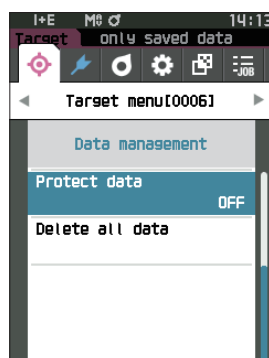

□ Delete All Data (Target)

Delete all the color difference target data that have been set.

Notes When the data is protected, "Delete all data" cannot be selected on the <Data management> screen.

Operating Procedure

Start the procedure from the <Target menu> - <Data management> screen.

- 1 Use [▲] or [▼] to move the cursor to "Delete all data", and then press the [Confirmation] key.

The <Delete all data> screen is displayed.

- 2 Use [◀] or [▶] to move the cursor to "OK" and press the [Confirmation] key to delete all data.

- When the deletion is complete, the screen returns to the <Target> screen.
- Moving the cursor to "Cancel" and pressing the [Confirmation] key will cancel the deletion of all data, and the screen will return to the <Data management> screen.



■ Pass/Fail

Edit the tolerance that will be used as the judgment criteria, and set the warning level and the parametric coefficient default value.

If the color difference between the sample and the target exceeds the tolerance, the column of the display color value relevant to the measurement display will be displayed in red. In addition, if even one display color value exceeds the tolerance, judgment will be shown as “Fail”.

If the color difference between the sample and the target exceeds the warning level amount, the column of the display color value relevant to the measurement display will be displayed in yellow. In such cases, even if other display color values do not exceed the tolerance, judgment will be shown as “Warning”.

- Memo**
- The default judgment criteria is set before judgment criteria for each target is set. For details, refer to P. 82 “Default Data Settings”.
 - The tolerance setting items are the same as those for the color space or index currently selected for the observation conditions.
 - The optional Color Data Software SpectraMagic NX2 allows for easy configuration and use of judgment criteria.
 - Display the target to be set in advance before moving to <Target menu>.

Operating Procedure

Start the procedure from the <Target menu> screen.

- 1 Use [**▲**] or [**▼**] to move the cursor to “Pass/Fail”, and then press the [Confirmation] key to display the <Pass/Fail> screen.

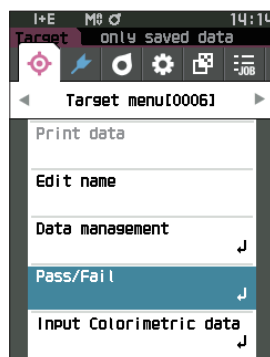

□ Tolerance Settings

Specify the tolerance used for pass/fail judgment of measured for each target.

Operating Procedure

Start the procedure from the <Target menu> - <Pass/Fail> screen.

- 1 Use [▲] or [▼] to move the cursor to “Edit tolerance”, and then press the [Confirmation] key.

The tolerance list screen is displayed.

- 2 Use [▲] or [▼] to move the cursor to the item to set, and then press the [Confirmation] key.

The <Edit tolerance> screen is displayed.

- 3 Use [▲]/[▼] and [◀]/[▶] to move the cursor to the item to set, and then press the [Confirmation] key to change the setting.

- When the selected item is not currently checked, pressing the [Confirmation] key causes the item to be checked, after which the setting value can be changed.
- Press [◀] or [▶] to move the cursor to the setting value area. Pressing the [Confirmation] key causes the cursor to appear on the value. Press [▲] or [▼] to change the value. Move the cursor between the digits of the value by pressing [◀] or [▶].

Settings

- x/y : -0.2000 to 0.2000
- Equation/MI : 0.00 to 20.00
- Other than the above : -20.00 to 20.00
- * ΔBlackness (My), ΔJetness (ΔMc), and ΔUndertone (dM) can only be set for SCE.
- Press the [Confirmation] key to confirm every time the setting of an item is changed.

- 4 After all settings have been configured, use [▲] or [▼] to move the cursor to “OK”, and then press the [Confirmation] key.

The setting is confirmed and the screen returns to the <Edit tolerance> screen.

If you press the [ESC] key during setting, the setting value of the open screen is return to the value before the change.

- 5 Press [ESC] to return to the <Pass/Fail> screen.

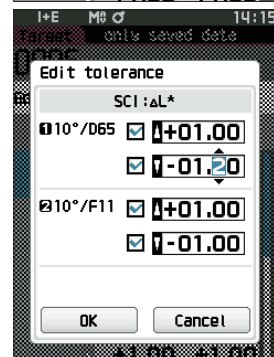
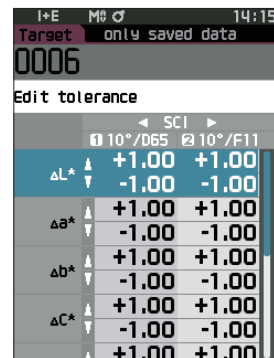
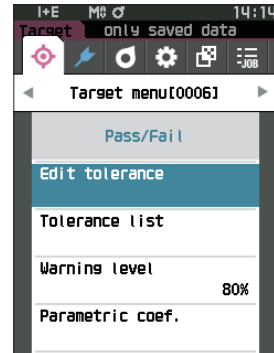

□ Tolerance List

Select the index used for sample pass/fail judgment.

Operating Procedure

Start the procedure from the <Target menu> - <Pass/Fail> screen.

- 1 Use [▲] or [▼] to move the cursor to “Tolerance list”, and then press the [Confirmation] key.

The available tolerances are displayed.



- 2 Use [▲] or [▼] to move the cursor to the item to set, and then press the [Confirmation] key.

- When the selected item is not currently checked, pressing the [Confirmation] key causes the item to be checked. When the selected item is currently checked, pressing the [Confirmation] key causes the item to be unchecked.
- Up to 14 indexes can be selected.



- 3 After all settings have been configured, use [▲] or [▼] to move the cursor to “OK”, and then press the [Confirmation] key.

The setting is confirmed and the screen returns to the <Pass/Fail> screen.

If [ESC] is pressed during configuration, the settings will not be changed and the screen will return to the <Pass/Fail> screen.

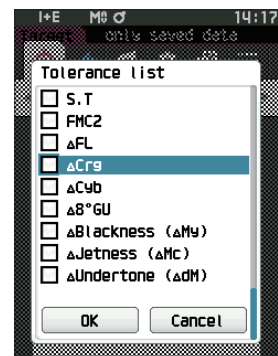

□ Warning Level Settings

When a warning level is set, warnings will be displayed when the measured data nears but does not exceed the tolerance.

Operating Procedure

Start the procedure from the <Target menu> - <Pass/Fail> screen.

- 1 Use [▲] or [▼] to move the cursor to “Warning level”, and then press the [Confirmation] key.

The <Warning level> screen is displayed.

- 2 Use [▲] or [▼] to change the value.
Settings

○ 000 to 100%

- 3 Press the [Confirmation] key after completing the changes.

The setting is confirmed and the screen returns to the <Pass/Fail> screen.

Notes If [ESC] is pressed during configuration, the settings will not be changed and the screen will return to the <Pass/Fail> screen.

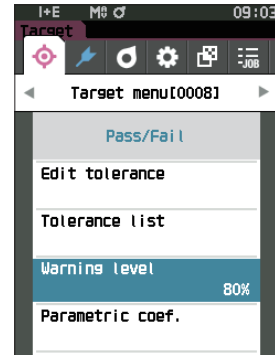

□ Parametric Coefficient Settings

Specify the parametric coefficient used for pass/fail judgment of a sample for each target.

Operating Procedure

Start the procedure from the <Target menu> - <Pass/Fail> screen.

- 1 Use [▲] or [▼] to move the cursor to “Parametric coef.”, and then press the [Confirmation] key.

The <Parametric coef.> screen is displayed.



- 2 Use [▲] or [▼] to move the cursor to the item to set, and then press the [Confirmation] key.

The <Parametric coef.> edit screen is displayed.

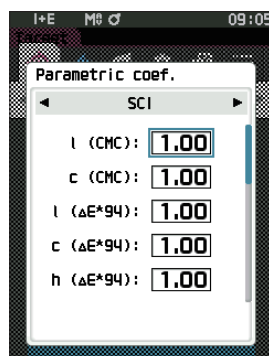

- 3 Use [▲] or [▼] to move the cursor to the item to set, and press the [Confirmation] key to change the setting.

- Pressing the [Confirmation] key causes the cursor to appear on the value. Press [▲] or [▼] to change the value. Move the cursor between the digits of the value by pressing [◀] or [▶].

Settings

○ 0.01 to 9.99

- Press the [Confirmation] key to confirm every time the setting of an item is changed.

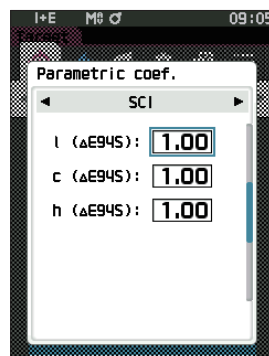

- 4 After all settings have been configured, use [▲] or [▼] to move the cursor to “OK”, and then press the [Confirmation] key.

The setting is confirmed and the screen returns to the <Pass/Fail> screen.

Memo If SCI+SCE is set for “Specular Component” under <Measurement setup>, use the [◀] or [▶] key to switch between SCI and SCE.

Notes If [ESC] is pressed during configuration, the settings will not be changed and the screen will return to the <Pass/Fail> screen.

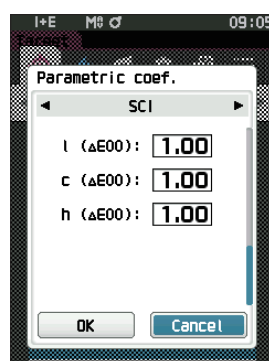

Input Colorimetric Data

Set the target by numerical input.

Select or specify the following items as the Input Colorimetric data.

- Color space : XYZ / L*a*b* / Hunter Lab
- Input Data : Enter the numeric value of the color space set above.

Operating Procedure

Start the procedure from the <Target menu> screen.

- 1 Use [▲] or [▼] to move the cursor to “Input Colorimetric data”, and then press the [Confirmation] key to display the <Input Colorimetric data> screen.

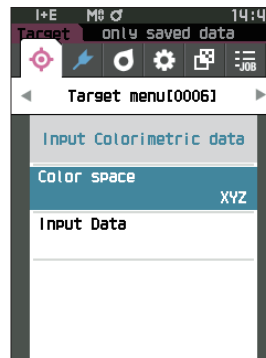

Color Space

Specify which color space to input the colorimetric data.

Operating Procedure

Start the procedure from the <Target menu> - <Input Colorimetric data> screen.

- 1 Use [▲] or [▼] to move the cursor to “Color space”, and then press the [Confirmation] key.
The <Color space> screen is displayed.

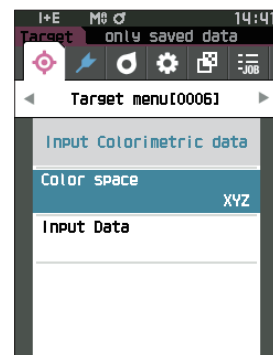

2 Use [▲] or [▼] to move the cursor to the item to set.

Settings

- XYZ : XYZ color space
- L*a*b* : L*a*b* color space
- Hunter Lab: Hunter Lab color space



3 Press the [Confirmation] key.

The setting is confirmed and the screen returns to the <Input Colorimetric data> screen.

Notes If [ESC] is pressed during configuration, the settings will not be changed and the screen will return to the <Input Colorimetric data> screen.

□ Input Data

Create the color values for the color space selected in “Input Colorimetric data” - “Color space”.

Operating Procedure

Start the procedure from the <Target menu> - <Input Colorimetric data> screen.

1 Use [▲] or [▼] to move the cursor to “Input Data”, and then press the [Confirmation] key.

The Input data list screen is displayed.

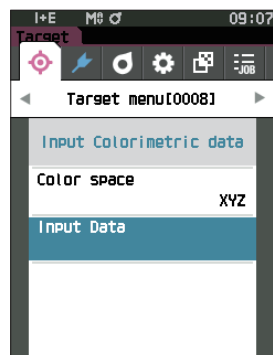

- 2 Use [▲] or [▼] to move the cursor to the item to set, and then press the [Confirmation] key.

The <Input Data> screen is displayed.

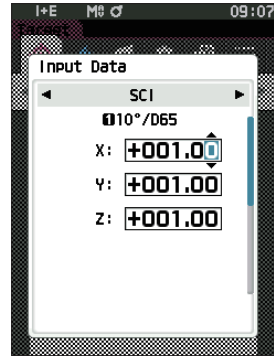

- 3 Use [▲] or [▼] to move the cursor to the item to set, and press the [Confirmation] key to change the setting.

- Press [◀] or [▶] to move the cursor to the setting value area. Pressing the [Confirmation] key causes the cursor to appear on the value. Press [▲] or [▼] to change the value.

Move the cursor between the digits of the value by pressing [◀] or [▶].

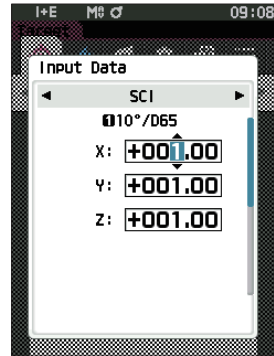

Settings

- X/Y/Z : 0.01 to +300.000
- L* : 0.00 to +300.000
 - a*/b* : -300.00 to +300.00
- L : 0.00 to +300.000
 - a/b : -300.00 to +300.00
- Press the [Confirmation] key to confirm every time the setting of an item is changed.

Memo If SCI+SCE is set for “Specular Component” under <Measurement setup>, use the [◀] or [▶] key to switch between SCI and SCE.

- 4 After all settings have been configured, use [▲] or [▼] to move the cursor to “OK”, and then press the [Confirmation] key.

The setting is confirmed and the screen returns to the <Target> screen.

Memo If SCI+SCE is set for “Specular Component” under <Measurement setup>, use the [◀] or [▶] key to switch between SCI and SCE.

- Notes**
- If [ESC] is pressed during configuration, the settings will not be changed and the screen will return to the <Input Colorimetric data> screen.
 - If the selected target data number is already linked to the opacity-measured sample data, it cannot be registered. Delete the linked opacity data or change the selected target data number.
 - If you change Observer/Illuminant after entering input data, note that the target data value is written as “---”.

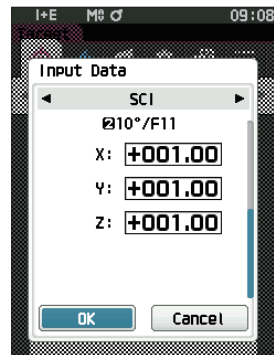

■ Default Data Settings

This instrument allows pass/fail judgment criteria to be set for individual color difference target data. Until such judgment criteria are set, the instrument is set with the default tolerance. Users can edit the tolerance that will be used as the judgment criteria as well as edit the warning level and the parametric coefficient default value.

- Memo**
- When a new target is measured, the default settings are initially applied.
 - The default judgment criteria is set before judgment criteria for each target is set.
 - Changing the default judgment criteria after the judgment criteria has already been set for individual targets, the judgment criteria specified for these targets will not be changed.
 - The optional Color Data Software SpectraMagic NX2 allows for easy configuration and use of judgment criteria.

Operating Procedure

Start the procedure from the measurement screen.

- 1 Press [MENU], and then use [◀] or [▶] to display the <Setting> screen.
- 2 Use [▲] or [▼] to move the cursor to “Default data setup”, and then press the [Confirmation] key to display the <Default data setup> screen.

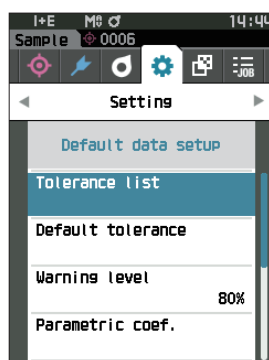
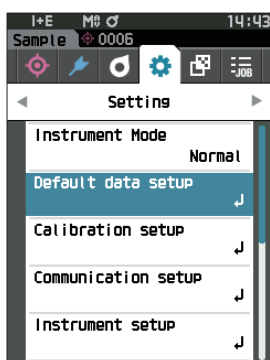

□ Tolerance List

Select the default index used for sample pass/fail judgment.

Operating Procedure

Start the procedure from the <Setting> - <Default data setup> screen.

- 1 Use [▲] or [▼] to move the cursor to “Tolerance list”, and then press the [Confirmation] key.

The available tolerances are displayed.

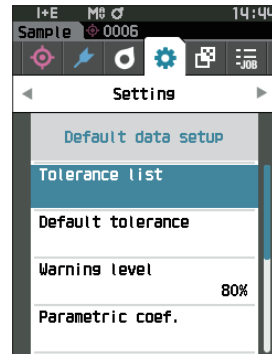

- 2 Use [▲] or [▼] to move the cursor to the item to set, and then press the [Confirmation] key.

- When the selected item is not currently checked, pressing the [Confirmation] key causes the item to be checked. When the selected item is currently checked, pressing the [Confirmation] key causes the item to be unchecked.
- Up to 14 indexes can be selected.

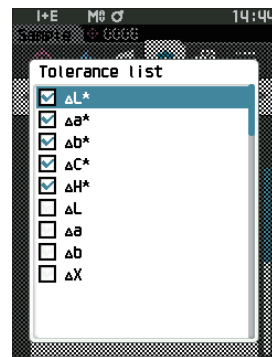

- 3 After all settings have been configured, use [▲] or [▼] to move the cursor to “OK”, and then press the [Confirmation] key.

The setting is confirmed and the screen returns to the <Default data setup> screen.

If you press the [ESC] key during setting, the setting value of the open screen is return to the value before the change.

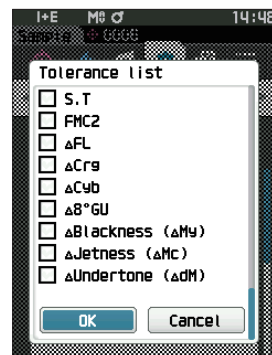

- 4 Press [ESC] to return to the <Default data setup> screen.

□ Default Tolerance Settings

- Memo** • The default tolerance is set to the following values when the instrument is shipped from the factory.
- Lower limit: -1.00, Upper limit: 1.00
 $\Delta x, \Delta y$ Lower limit: -0.0100, Upper limit: 0.0100

Operating Procedure

Start the procedure from the <Setting> - <Default data setup> screen.

- 1 Move the cursor to “Default tolerance”, and then press the [Confirmation] key.

The tolerance list screen is displayed.

- 2 Use [\blacktriangle] or [\blacktriangledown] to move the cursor to the item to set, and then press the [Confirmation] key.

The <Edit tolerance> screen is displayed.

- 3 Use [\blacktriangle]/[\blacktriangledown] and [\blacktriangleleft]/[\blacktriangleright] to move the cursor to the item to set, and then press the [Confirmation] key to change the setting.

- When the selected item is not currently checked, pressing the [Confirmation] key causes the item to be checked, after which the setting value can be changed.
- Press [\blacktriangleleft] or [\blacktriangleright] to move the cursor to the setting value area. Pressing the [Confirmation] key causes the cursor to appear on the value. Press [\blacktriangle] or [\blacktriangledown] to change the value. Move the cursor between the digits of the value by pressing [\blacktriangleleft] or [\blacktriangleright].

Settings

- x/y : -0.2000 to 0.2000
- Equation/MI : 0.00 to 20.00
- Other than the above : -20.00 to 20.00
- * Δ Blackness (My), Δ Jetness (Δ Mc), and Δ Undertone (dM) can only be set for SCE.
- Press the [Confirmation] key to confirm every time the setting of an item is changed.

- 4 After all settings have been configured, use [\blacktriangle] or [\blacktriangledown] to move the cursor to “OK”, and then press the [Confirmation] key.

The setting is confirmed and the screen returns to the <Default tolerance> screen.

- Memo** If SCI+SCE is set for “Specular Component” under <Measurement setup>, use the [\blacktriangleleft] or [\blacktriangleright] key to switch between SCI and SCE.

- 5 Press [ESC] to return to the <Default data setup> screen.

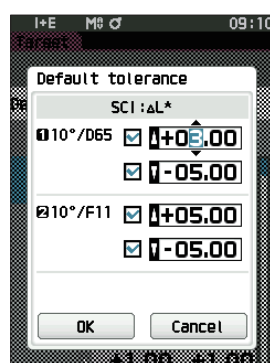
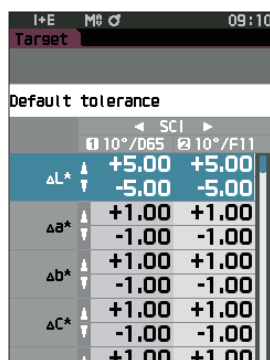
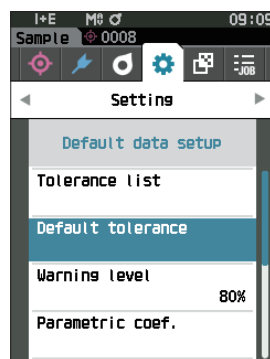

□ Warning Level Settings

Memo The warning level is set to “80%” when the instrument is shipped from the factory.

Operating Procedure

Start the procedure from the <Setting> - <Default data setup> screen.

- 1 Use [▲] or [▼] to move the cursor to “Warning level”, and then press the [Confirmation] key.

The <Warning level> screen is displayed.

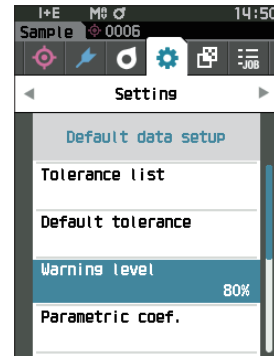

- 2 Use [▲] or [▼] to change the value.

Settings

○ 000 to 100%

- 3 Press the [Confirmation] key after completing the changes.

The setting is confirmed and the screen returns to the <Default data setup> screen.

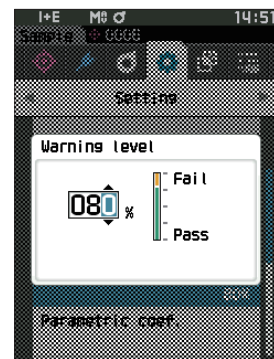

Notes If [ESC] is pressed during configuration, the settings will not be changed and the screen will return to the <Default data setup> screen.

□ Parametric Coefficient Settings

Memo The parametric coefficient is set to “1.00” when the instrument is shipped from the factory.

Operating Procedure

Start the procedure from the <Setting> - <Default data setup> screen.

- 1 Use [▲] or [▼] to move the cursor to “Parametric coef.”, and then press the [Confirmation] key.

The <Parametric coef.> screen is displayed.

- 2 Use [▲] or [▼] to move the cursor to the item to be set, and then press the [Confirmation] key.

The <Parametric coef.> edit screen is displayed.

- 3 Use [▲] or [▼] to move the cursor to the item to set, and press the [Confirmation] key to change the setting.

- Pressing the [Confirmation] key causes the cursor to appear on the value. Press [▲] or [▼] to change the value. Move the cursor between the digits of the value by pressing [◀] or [▶].

Settings

○ 0.01 to 9.99

- Press the [Confirmation] key to confirm every time the setting of an item is changed.

- 4 After all settings have been configured, use [▲] or [▼] to move the cursor to “OK”, and then press the [Confirmation] key.

The setting is confirmed and the screen returns to the <Default data setup> screen.

Memo If SCI+SCE is set for “Specular Component” under <Measurement setup>, use the [◀] or [▶] key to switch between SCI and SCE.

Notes If [ESC] is pressed during configuration, the settings will not be changed and the screen will return to the <Parametric coef.> screen.

- 5 Press [ESC] to return to the <Default data setup> screen.

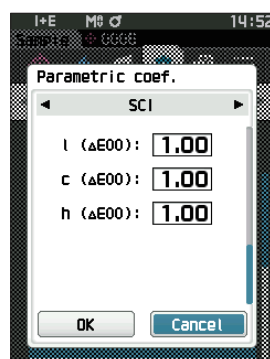
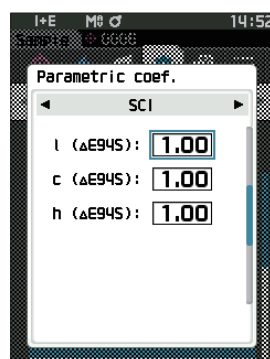
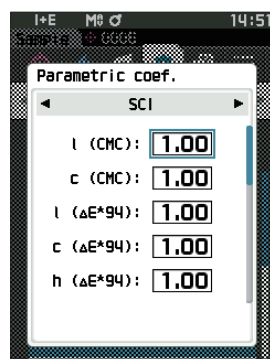
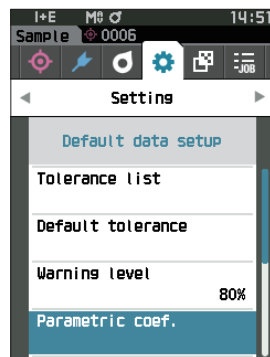

□ Set Group

Create groups for registering targets in advance.

Memo No group name is set when the instrument is shipped from the factory.

Operating Procedure

Start the procedure from the <Setting> - <Default data setup> screen.

1 Use [▲] or [▼] to move the cursor to “Set group”, and then press the [Confirmation] key.

The <Set group> screen is displayed.

The currently selected group numbers and names will be displayed in the upper table. The group is set by default when the target is measured.

The cursor will appear in the lower area with group numbers.

Configure the group name.

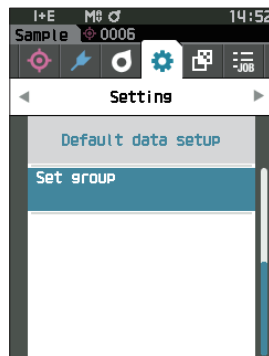

2 Use [▲] or [▼] to move the cursor to the group number of the group to edit. Numbers with blank names have not yet been set as a group. Assigning a name will register the number as a group. Users can also edit the names of existing groups.

Groups 01 through 50 can be set with up to 5 groups being available for registration.

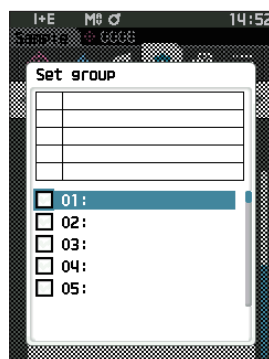

3 Check the box of the number to register to edit the name.

The <Edit name> screen is displayed.

Memo Checking the box registers the number to the table above, and when the target is measured, the number is automatically assigned to the affiliated group. To delete the information from the table, uncheck the box.



4 Use [▲]/[▼] or [◀]/[▶] to move the cursor between characters, and then press the [Confirmation] key.

- Up to 30 characters can be used.
- The selected character is displayed in the text box.

5 Repeat step 2 until the necessary characters have been entered.

- To delete the character to the left of the cursor in the text box, move the cursor to [x] and press the **[Confirmation]** key.

6 After inputting the characters, move the cursor to [OK] and press the [Confirmation] key.

The setting is confirmed and the screen returns to the **<Set group>** screen.

Memo If **[ESC]** is pressed during configuration, or if the cursor is moved to "Cancel" and the **[Confirmation]** key is pressed, the settings will not be changed and the screen will return to the **<Set group>** screen.

7 Move the cursor to [OK] (located below 50, which is at the very bottom), and press the [Confirmation] key.

The screen will return to the <Default data setup> screen.

Be aware that failure to press the [Confirmation] key on **[OK]** will cancel all data. Proceed with caution.

Chapter 3

Setting

Measurement Condition Settings.....	91
■ Measurement Condition Settings	91
■ Opacity Measurement	93
■ Measurement Option Settings.....	95
■ Observation Condition Settings.....	103
■ Display Settings	107
Instrument Settings	112
■ Measurement Instrument Option Settings....	112

Measurement Condition Settings

This instrument requires measurement condition settings (measurement mode, average count, observer/illuminant, and display) to be configured before measurement can be started.

■ Measurement Condition Settings

To set measurement conditions, select the setting from the <Measurement cond.> menu. The following four items can be specified as the measurement conditions:

- Measurement mode : Select the color or opacity.
- Measurement setup : Specify the number of measurements for automatic and manual averaging.
- Observer/Illuminant : Configure the two observers/illuminants.
- Display cond. : Configure the display type, color space, color difference equation, and 14 custom display items.

Operating Procedure

- 1 Press [MENU], and then use [◀] or [▶] to display the <Measurement cond.> menu screen.

Memo To return to the previous screen, press [MENU] or [ESC].

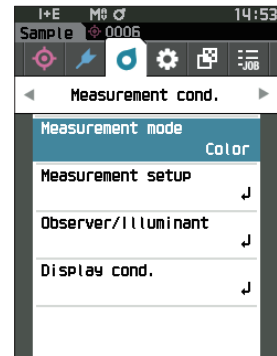

□ Measurement Mode

Select a measurement mode.

Memo The measurement mode is set to “Color” when the instrument is shipped from the factory.

Operating Procedure

Start the procedure from the <Measurement cond.> screen.

- 1 Use [▲] or [▼] to move the cursor to “Measurement mode”, and then press the [Confirmation] key.

The <Measurement mode> screen is displayed.

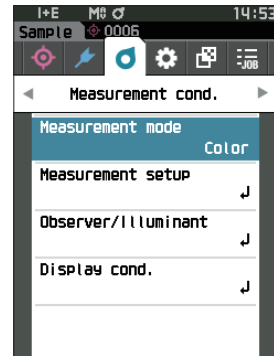

- 2 Use [▲] or [▼] to move the cursor to the desired measurement mode.

Settings

- Color: Colorimetry
- Opacity: Opacity value measurement

- 3 Press the [Confirmation] key to confirm, and then press [ESC].

The selection is confirmed and the screen returns to the previous screen.

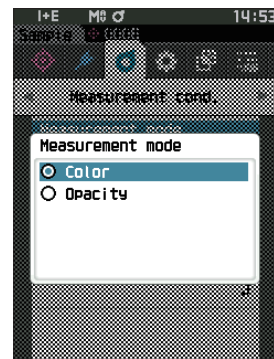

Notes If [ESC] is pressed without pressing the [Confirmation] key, the settings will not be changed and the screen will return to the previous screen.

■ Opacity Measurement

The transparency and opacity of paper are displayed as numerical values.

If the specimen is opaque, the value is determined only by the brightness of the specimen with no influence from the background, so the value for a white background will be the same as for a black background, and the opacity value (OP value) will be 100%.

Memo Manual averaging and SMC measurement cannot be used in Opacity mode, and the measurement conditions are only SCI or SCE. SCI+SCE cannot be selected.

Notes To measure in Opacity mode, the target must also be measured in Opacity mode. In addition, when measuring according to a specific international standard, the visual field and the light source must also be set according to the standard.

Preparation

1 Select "Opacity" under <Measurement cond.> - <Measurement mode>.

2 Press [ESC] on the menu screen to display the <Target> screen.

From the sample screen, press [/] key to display the <Target> screen.

Operating Procedure

1 **Selecting or measuring a target**

Select a target measured beforehand in Opacity mode, or measure a new target in Opacity mode. Press "Cancel" during the operation to return to the screen before measurement.



2 Measuring a sample

Press "Cancel" during the operation to return to the screen before measurement.

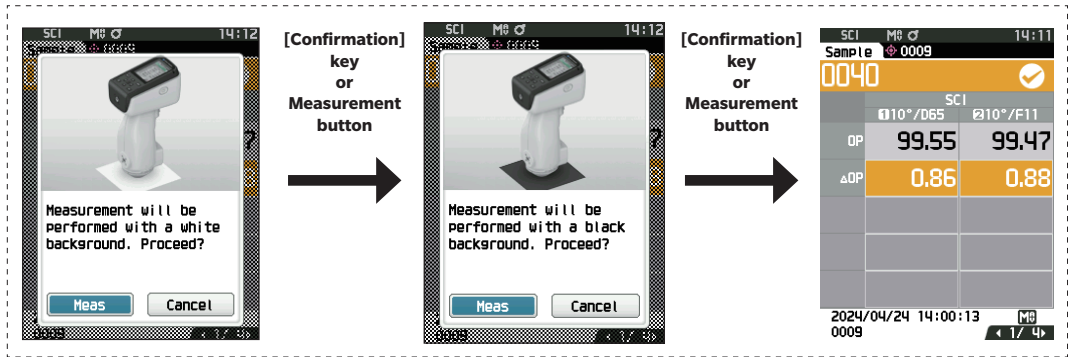

3 Displaying the results

Opacity value (OP value)

Color difference value

White background

L*a*b* value

Black background

L*a*b* value

OP	98.63	98.59
ΔOP	-0.06	-0.01

L*	79.90	81.35
a*	5.19	5.42
b*	27.50	30.78

L*	79.46	80.89
a*	4.85	5.10
b*	27.23	30.49

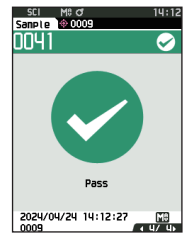

■ Measurement Option Settings

To set measurement options, select “Measurement setup” from the <Measurement cond.> menu screen. Select or specify the following items as the measurement options.

- Specular Component : SCI (incl. reflected light) / SCE (excl. reflected light) / Simultaneous SCI+SCE measurement
- Auto average (1 to 10) : Specify the number of measurements for auto averaging.
- Manual average (1 to 30) : Specify the number of measurements for manual averaging.
- Manual average option : Select the save method when performing manual averaging.
- SMC average option : Select the save method when performing SMC average measurement.
(When SMC function is ON)
- SMC : Remove outliers beyond the threshold before performing measurement.
- SMC Threshold : Set the threshold for SMC measurement.
- SMC Times (3 to 10) : Set the number of measurements to perform when performing SMC measurement.
- Output Minus : Set data output ON/OFF for reflectance of 0% or less.

Operating Procedure

Start the procedure from the measurement screen.

- 1 Press [MENU], and then use [◀] or [▶] to display the <Measurement cond.> menu screen.

Memo To return to the previous screen, press [MENU] or [ESC].

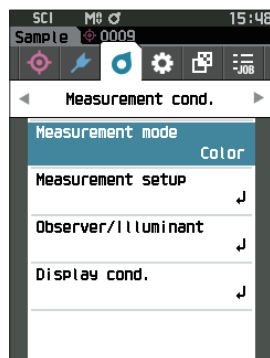

- 2 Use [▲] or [▼] to move the cursor to “Measurement setup”, and then press the [Confirmation] key.

The <Measurement setup> screen is displayed.

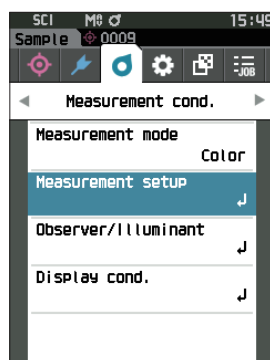

- 3 After setting the measurement conditions, press the [ESC] to return to the previous screen.

□ Specular Component

Select the method for processing the sample specular reflection light.

Memo The specular component is set to “SCI+SCE” when the instrument is shipped from the factory.

Operating Procedure

Start the procedure from the <Measurement cond.> - <Measurement setup> screen.

- 1 Use [▲] or [▼] to move the cursor to “Specular Component”, and then press the [Confirmation] key.

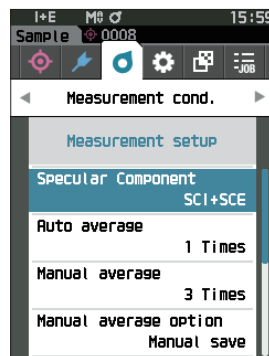

- 2 Use [▲] or [▼] to move the cursor to the item to set, and then press the [Confirmation] key.

Settings

- SCI : Measurement using a light source that contains specular reflection light.
- SCE : Measurement using a light source that excludes specular reflection light.
- SCI+SCE : Displays the results of both SCI and SCE measurements.



- 3 Press the [Confirmation] key.

The selection is confirmed and the screen returns to the <Measurement setup> screen.

Notes If [ESC] is pressed without pressing the [Confirmation] key, the settings will not be changed and the screen will return to the <Measurement setup> screen.

□ Auto Average (1 to 10)

Specify the number of measurements for auto averaging. Every time the measurement button is pressed, the average of the data obtained from the specified number of continuous measurements is determined as sample data.

Memo "1" is set as the number of measurements for automatic averaging when the instrument is shipped from the factory.

Operating Procedure

Start the procedure from the <Measurement cond.> - <Measurement setup> screen.

- 1 Use [▲] or [▼] to move the cursor to "Auto average", and then press the [Confirmation] key.

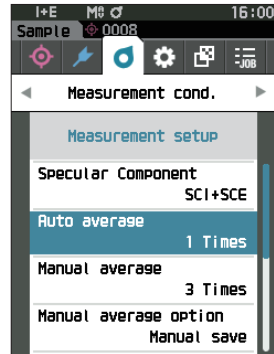

- 2 ▲ and ▼ will be displayed above and below the count in the count selection. Use [▲] or [▼] to specify a value.

Settings

- 1 to 10 times:
Specify the number of measurements, from 1 to 10, to perform when using auto averaging.

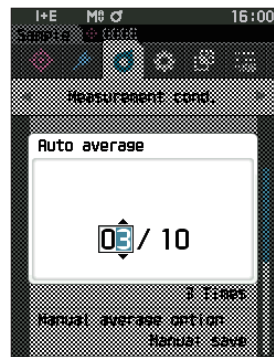

- 3 Press the [Confirmation] key.

The selection is confirmed and the screen returns to the <Measurement setup> screen.

Notes If [ESC] is pressed without pressing the [Confirmation] key, the settings will not be changed and the screen will return to the <Measurement setup> screen.

□ Manual Average (1 to 30)

Specify the number of measurements for manual averaging. The average of the data obtained from the measurements conducted by pressing the measurement button the specified number of times is determined as sample data.

Memo "1" is set as the number of measurements for manual averaging when the instrument is shipped from the factory.

Operating Procedure

Start the procedure from the <Measurement cond.> - <Measurement setup> screen.

- 1 Use [▲] or [▼] to move the cursor to "Manual average", and then press the [Confirmation] key.

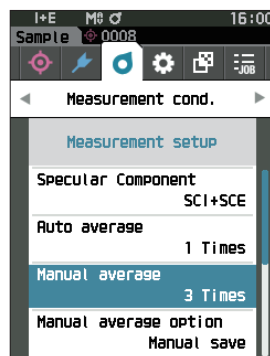

- 2 ▲ and ▼ will be displayed above and below the count in the count selection. Use [▲] or [▼] to specify a value.

Settings

- 1 to 30 times:
Specify the number of measurements, from 1 to 30, to perform when using manual averaging.

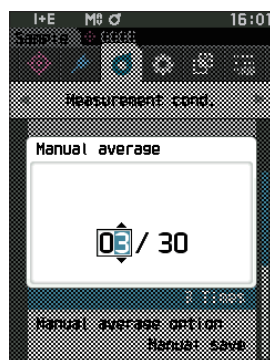

- 3 Press the [Confirmation] key.

The selection is confirmed and the screen returns to the <Measurement setup> screen.

Notes If [ESC] is pressed without pressing the [Confirmation] key, the settings will not be changed and the screen will return to the <Measurement setup> screen.

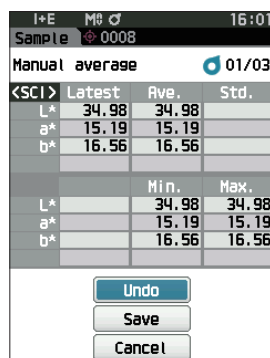

With manual average measurement, measurement is performed for the configured number of times the measurement button is pressed, and the average value of those measurements is saved as a single measurement. Selecting "Undo" after a measurement allows users to perform the previous measurement again.

After the set number of measurements has been performed, the average can be saved by selecting "Save". To save the average automatically after the set number of measurements has been performed, select "Auto save" under "Measurement cond." - "Measurement setup" - "Manual average option".



□ SMC Function (Outlier-Free Measurement)

The SMC (Statistical Measurement Control) function acquires the average using values that minimize variations in the measured data.

Memo SMC is set to “OFF” when the instrument is shipped from the factory.

Operating Procedure

Start the procedure from the <Measurement cond.> - <Measurement setup> screen.

- 1 Use [▲] or [▼] to move the cursor to “SMC”, and then press the [Confirmation] key.

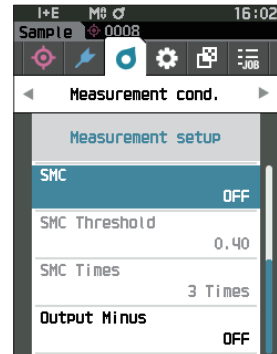

- 2 Use [▲] or [▼] to move the cursor to the item to set, and then press the [Confirmation] key.

Settings

- OFF
- ON

Notes Setting the SMC function to ON will disable manual averaging.

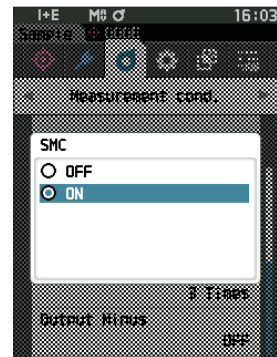

- 3 Press the [Confirmation] key.

The selection is confirmed and the screen returns to the <Measurement setup> screen.

Notes If [ESC] is pressed without pressing the [Confirmation] key, the settings will not be changed and the screen will return to the <Measurement setup> screen.

□ SMC Threshold

Sets the threshold to be used for the sample SMC function.

- Memo**
- The SMC threshold is set to “0.4” when the instrument is shipped from the factory.
 - For the threshold value, enter a value equivalent to the desired $\sigma\Delta E^*ab$ for the average measurement data group (average data entries set on P. 91).

Operating Procedure

Start the procedure from the <Measurement cond.> - <Measurement setup> screen.

- 1 Use [▲] or [▼] to move the cursor to “SMC Threshold”, and then press the [Confirmation] key.

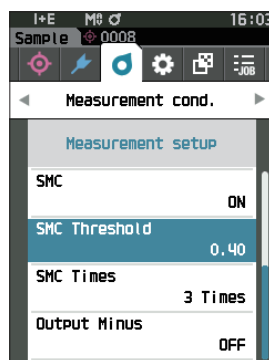

- 2 ▲ and ▼ are displayed above and below the number to be set.
Use [▲] or [▼] to specify a value.

Settings

- 0.01 to 9.99

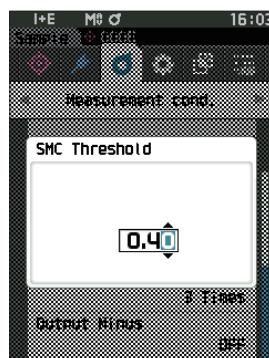

- 3 Press the [Confirmation] key.
The selection is confirmed and the screen returns to the <Measurement setup> screen.

- Notes** If [ESC] is pressed without pressing the [Confirmation] key, the settings will not be changed and the screen will return to the <Measurement setup> screen.

□ SMC Times

Sets the threshold to be used for the sample SMC function.

Sets the number of measurements to perform when performing SMC average measurement. The average of the data obtained from the measurements conducted by pressing the measurement button several times is determined. The maximum number of measurements at this time is specified number in the setting + four times.

Memo "3" is set as the number of measurements for SMC averaging when the instrument is shipped from the factory.

Operating Procedure

Start the procedure from the <Measurement cond.> - <Measurement setup> screen.

- 1 Use [▲] or [▼] to move the cursor to "SMC Times", and then press the [Confirmation] key.

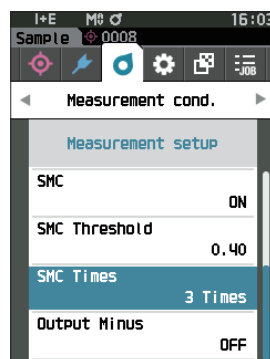

- 2 ▲ and ▼ will be displayed above and below the count in the count selection. Use [▲] or [▼] to specify a value.

Settings

- 3 to 10 times

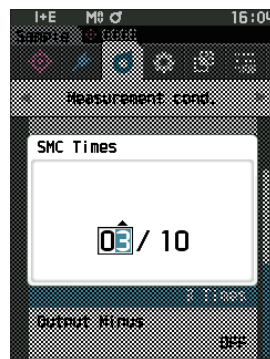

- 3 Press the [Confirmation] key.

The selection is confirmed and the screen returns to the <Measurement setup> screen.

Notes If [ESC] is pressed without pressing the [Confirmation] key, the settings will not be changed and the screen will return to the <Measurement setup> screen.

With SMC average measurement, measurement is performed for the configured number of times the measurement button is pressed, and the average value of those measurements is saved as a single measurement. After the set number of measurements has been performed, the average can be saved by selecting "Save". To save the average automatically after the set number of measurements has been performed, select "Auto save" under "Measurement cond." - "Measurement setup" - "SMC average option".

□ Output Minus

Output Minus ON : Used in situations where a low reflectance sample with reflectance near 0% is to be measured.

Output Minus OFF : If a sample with reflectance below the lower limit (-10%) is used, a measurement error will normally occur, but by turning this function OFF, the output will be 0.01% for samples with a reflectance of 0% or lower.

Memo Output minus is set to "ON" when the instrument is shipped from the factory.

Operating Procedure

Start the procedure from the <Measurement cond.> - <Measurement setup> screen.

- 1 Use [▲] or [▼] to move the cursor to "Output Minus", and then press the [Confirmation] key.

Memo To return to the previous screen, press [MENU] or [ESC].

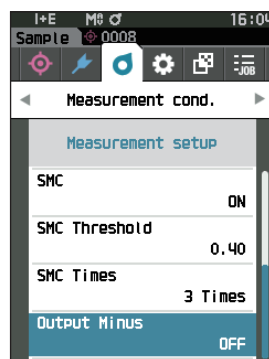

- 2 Use [▲] or [▼] to move the cursor to the item to set, and then press the [Confirmation] key.

Settings

- OFF
- ON

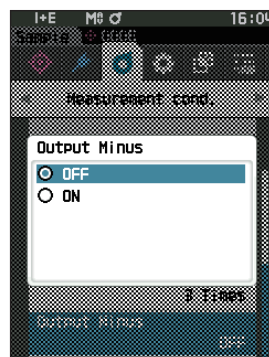

- 3 Press the [Confirmation] key.

The selection is confirmed and the screen returns to the <Measurement setup> screen.

Notes If [ESC] is pressed without pressing the [Confirmation] key, the settings will not be changed and the screen will return to the <Measurement setup> screen.

■ Observation Condition Settings

To set observation conditions, select “Observer/Illuminant” from the <Measurement cond.> menu screen.

The following two observer/illuminant settings can be configured for the observation conditions.

- Observer/Illuminant 1: Select the observer/illuminant used to measure the colorimetric value.
- Observer/Illuminant 2: Select the secondary illuminant used for MI (metamerism index) calculation, etc.

Operating Procedure

Start the procedure from the measurement screen.

- 1 Press [MENU], and then use [◀] or [▶] to display the <Measurement cond.> menu screen.

Memo To return to the previous screen, press [MENU] or [ESC].

- 2 Use [▲] or [▼] to move the cursor to “Observer/Illuminant”, and then press the [Confirmation] key. The <Observer/Illuminant> screen is displayed.

- 3 After setting the observer/illuminant, press [ESC] to return to the previous screen.

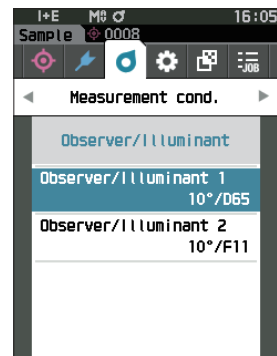
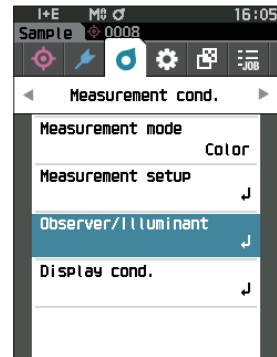

□ Observer/Illuminant 1

Select an observer angle of either 2° or 10° and the illuminant used to measure colorimetric value.

Memo Observer/Illuminant 1 is set to “10°/D65” when the instrument is shipped from the factory.

Operating Procedure

Start the procedure from the <Measurement cond.> - <Observer/Illuminant> screen.

- 1 Use [▲] or [▼] to move the cursor to “Observer/Illuminant 1”, and then press the [Confirmation] key.

The <Observer/Illuminant 1> screen is displayed.

The scroll bar on the right of the screen shows that there are additional observer/illuminant settings that cannot fit on the screen.

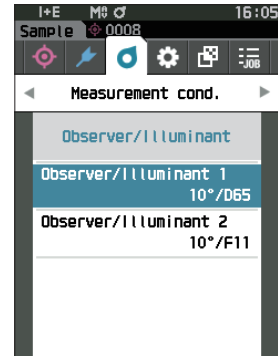

2 Use [▲] or [▼] to move the cursor to the desired item.

Moving the cursor past the top or bottom of the list will show additional observers/illuminants that cannot fit on the screen.

Settings

- 2°: 2° observer angle (CIE 1931)
- 10°: 10° observer angle (CIE 1964)

and

- A : Standard illuminant A (Incandescent lamp, Color temperature: 2856 K)
- C : Illuminant C (Daylight, Small relative value of spectral distribution in the ultraviolet region; Color temperature: 6774 K)
- D65 : Standard illuminant D₆₅ (Daylight, Color temperature: 6504K)
- D50 : Standard illuminant D₅₀ (Daylight, Color temperature: 5003K)
- ID65 : Indoor daylight illuminant ID65 (Daylight after passing through window glass, Color temperature: 6504K)
- ID50 : Indoor daylight illuminant ID50 (Daylight after passing through window glass, Color temperature: 5003K)
- F2 : Cool white (fluorescent lamp)
- F6 : Cool white (fluorescent lamp)
- F7 : Color rendering A daylight natural (fluorescent lamp)
- F8 : Color rendering AAA natural white (fluorescent lamp)
- F10 : 3-band type natural white (fluorescent lamp)
- F11 : 3-band type cool white (fluorescent lamp)
- F12 : 3-band type warm white (fluorescent lamp)
- LED-B1 : Blue exciting phosphor type LED (Color temperature: 2733 K)
- LED-B2 : Blue exciting phosphor type LED (Color temperature: 2998 K)
- LED-B3 : Blue exciting phosphor type LED (Color temperature: 4103 K)
- LED-B4 : Blue exciting phosphor type LED (Color temperature: 5109 K)
- LED-B5 : Blue exciting phosphor type LED (Color temperature: 6598 K)
- LED-BH1 : Hybrid type LED consisting of mix of phosphor-replaced blue LED and red LED (Color temperature: 2851 K)
- LED-RGB1 : LED mixing three LED (red, green, blue) (Color temperature: 2840 K)
- LED-V1 : Purple exciting phosphor type LED (Color temperature: 2724 K)
- LED-V2 : Purple exciting phosphor type LED (Color temperature: 4070 K)
- User1/User2/User3: User-configured illuminant
(* Optional Color Data Software SpectraMagic NX2 is required for setting user-configured illuminants. Note that the name configured in SpectraMagic NX2 will be displayed.)

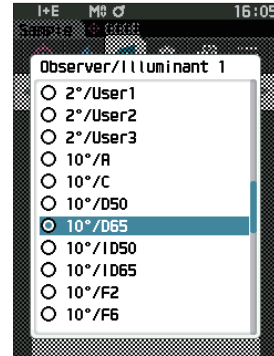

3 Press the [Confirmation] key.

The selection is confirmed and the screen returns to the <Observer/Illuminant> screen.

Notes If [ESC] is pressed without pressing the [Confirmation] key, the settings will not be changed and the screen will return to the <Observer/Illuminant> screen.

□ Observer/Illuminant 2

Select the secondary illuminant used for MI (metamerism index) calculation, etc.

Memo Observer/Illuminant 2 is set to “10°/F11” when the instrument is shipped from the factory.

Operating Procedure

Start the procedure from the <Measurement cond.> - <Observer/Illuminant> screen.

- 1 Use [▲] or [▼] to move the cursor to “Observer/Illuminant 2”, and then press the [Confirmation] key.

The <Observer/Illuminant 2> screen is displayed.

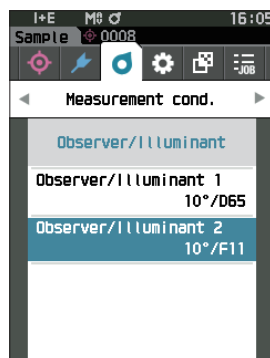

- 2 Use [▲] or [▼] to move the cursor to the desired item.

Settings

- The setting values are the same as those for “Observer/Illuminant 1” or “None”.

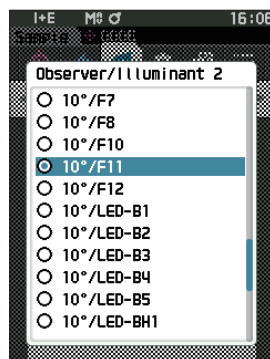

- 3 Press the [Confirmation] key.

The selection is confirmed and the screen returns to the <Observer/Illuminant> screen.

Notes If [ESC] is pressed without pressing the [Confirmation] key, the settings will not be changed and the screen will return to the <Observer/Illuminant> screen.

■ Display Settings

To set display settings, select “Display cond.” from the <Measurement cond.> menu screen. The following four items (three items and 14 custom display items) can be specified as the display conditions.

- Display type : Select the screen to be displayed.
- Color space : Select the color space to be displayed.
- Equation : Select the color for which the color difference will be measured.
- Custom (01 to 14) : Select which options to add to the display, such as display color value, index, and color difference.

Operating Procedure

Start the procedure from the measurement screen.

- 1 Press [MENU], and then use [◀] or [▶] to display the <Measurement cond.> menu screen.

Memo To return to the previous screen, press [MENU] or [ESC].

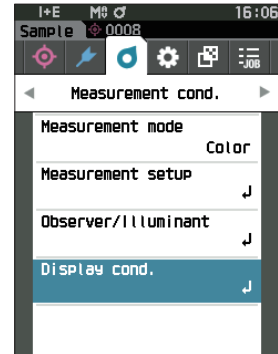

- 2 Use [▲] or [▼] to move the cursor to “Display cond.”, and then press the [Confirmation] key. The <Display cond.> screen is displayed.

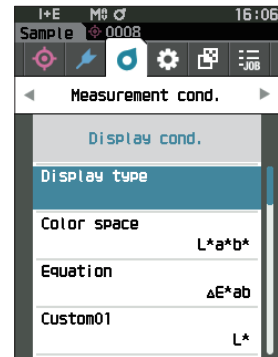

- 3 After setting the display conditions, press [ESC] to return to the previous screen.

□ Display Type

Configure the display type for the measurement results.

Memo All display types are selected when the instrument is shipped from the factory.

Operating Procedure

Start the procedure from the <Measurement cond.> - <Display cond.> screen.

- 1 Use [▲] or [▼] to move the cursor to “Display type”, and then press the [Confirmation] key.

The <Display type> screen is displayed.

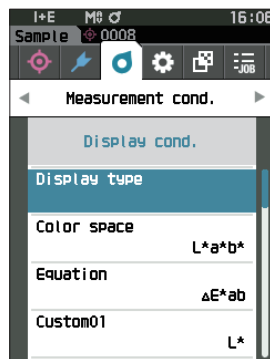

- 2 Use [▲] or [▼] to move the cursor to the desired display type, and then press the [Confirmation] key.

Settings

- Absolute value: Displays the absolute value of the colorimetric.
- Difference: Displays the color difference against the target color. The measurement that failed the pass/fail judgment based on the tolerance will be highlighted in red.
- Abs. & Diff.: Displays the absolute value and the color difference against the target color. The measurement that failed the pass/fail judgment based on the tolerance will be highlighted in red.
- Pass/Fail: Determines whether the color difference and gloss value difference related to the target are within the tolerance range set in advance. If within the tolerance, the judgment will be displayed as “Pass”. If even one difference is not within the tolerance, the judgment will be displayed as “Fail”.
- Custom: Displays the display color value and index set under “Custom” as the two illuminants.
- Abs. Graph: Displays a graph of the absolute value of the colorimetric.
- Diff. Graph: Displays a graph showing the color difference against the target color.
- Spectral Graph: Displays a graph showing the spectral reflectance. The [Confirmation] key can be used to move the wavelength displaying the spectral reflectance value.

Memo A check mark means the item is selected.

- 3 After all settings have been configured, use [▲] or [▼] to move the cursor to “OK”, and then press the [Confirmation] key.

The selection is confirmed and the screen returns to the previous screen.

Notes If [ESC] is pressed without pressing the [Confirmation] key, the settings will not be changed, and the screen will return to the <Display cond.> screen.

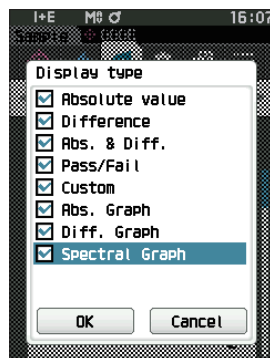

□ Color Space

Select the color space to be used.

Memo The color space is set to "L*a*b*" when the instrument is shipped from the factory.

Operating Procedure

Start the procedure from the <Measurement cond.> - <Display cond.> screen.

- 1 Use [▲] or [▼] to move the cursor to "Color space", and then press the [Confirmation] key.

The <Color space> selection screen is displayed.

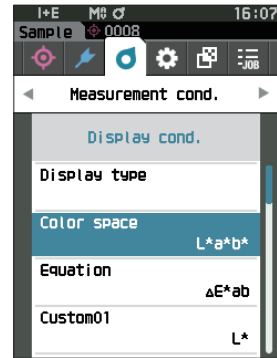

- 2 Use [▲] or [▼] to move the cursor to the desired color space.

Settings

- L*a*b*: L*a*b* color space
- L*C*h: L*C*h color space
- Hunter Lab: Hunter Lab color space
- Yxy: Yxy color space
- XYZ: XYZ color space
- Munsell (C): Munsell color space

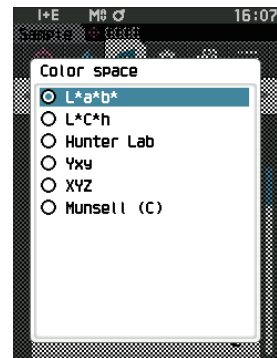

- 3 Press the [Confirmation] key to confirm, and then press [ESC].

The selection is confirmed and the screen returns to the previous screen.

Notes If [ESC] is pressed without pressing the [Confirmation] key, the settings will not be changed, and the screen will return to the <Display cond.> screen.

□ Color Difference Equation

Select the color difference equation to be used.

Memo The color difference equation is set to “ ΔE^*ab ” when the instrument is shipped from the factory.

Operating Procedure

Start the procedure from the <Measurement cond.> - <Display cond.> screen.

- 1 Use [\blacktriangle] or [\blacktriangledown] to move the cursor to “Equation”, and then press the [Confirmation] key.

The <Equation> screen is displayed.

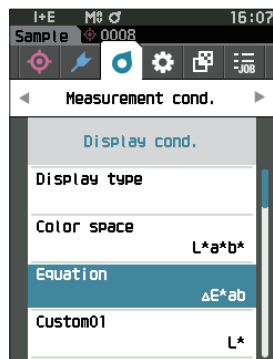

- 2 Use [\blacktriangle] or [\blacktriangledown] to move the cursor to the desired color difference equation.

Settings

- ΔE^*ab : ΔE^*ab (CIE 1976) color difference equation
- CMC: CMC color difference equation; parameters can be changed.
- ΔE^*94 (Special) *, ΔE^*94 : ΔE^*
 - * When comparing two colors, ΔE^*94 (Special) should be used if one color or the other is not specified as the standard.
- $\Delta E00$: $\Delta E00$ (CIEDE2000) color difference equation; parameters can be changed.
- ΔE (Hunter): Hunter Lab color difference equation
- $\Delta E99o$: $\Delta E99o$ (DIN99o) color difference equation
- FMC2: FMC-2 color difference equation

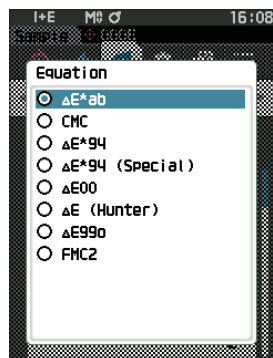

- 3 Press the [Confirmation] key to confirm, and then press [ESC].

The selection is confirmed and the screen returns to the previous screen.

Notes If [ESC] is pressed without pressing the [Confirmation] key, the settings will not be changed, and the screen will return to the <Display cond.> screen.

□ Custom

Select the items, including the color space, color difference equation, or index, to be used. Up to 14 items (Custom 01 to Custom 14) to be displayed can be set. This selection screen is available when the user equation has been set with the optional Color Data Software SpectraMagic NX2 in advance. In this case, the name configured in SpectraMagic NX2 will be displayed.

Operating Procedure

Start the procedure from the <Measurement cond.> - <Display cond.> screen.

1 Use [▲] or [▼] to move the cursor to “Custom xx (01 to 14)”, and then press the [Confirmation] key.

The screen for selecting the display items is displayed.

The scroll bar at the right on the screen shows that there are additional display items that cannot fit on the screen.

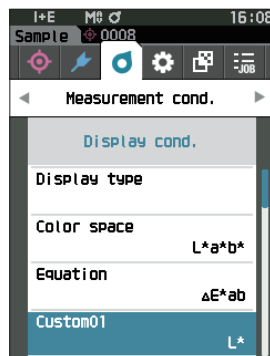

2 Use [▲] or [▼] to move the cursor to the desired display item.

Moving the cursor past the top or bottom of the list will show additional display items that cannot fit on the screen.

Settings

The following indexes as well as display color values and color differences for color spaces that can be configured under color space and color difference equation can be set.

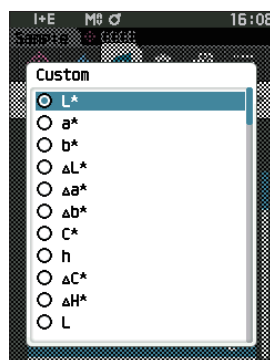

- Wle (WI E313-73) and ΔWle : Whiteness index (ASTM E313-73)
- Wlc (WI CIE) and ΔWlc : Whiteness index (CIE 1982/ASTM E313-98 (D65 illuminant))
- Tint (Tint CIE) and ΔTint : Tint (CIE 1982/ASTM E313-98 (D65 illuminant))
- Yle (YI E313-73) and ΔYle : Yellowness index (ASTM E313-73)
- Yld (YI D1925) and ΔYld : Yellowness index (ASTM D1925)
- B (ISO B) and ΔB : Brightness
- DXYZ/DX/DY/DZ : Strength
- MI : Metamerism
- 8°GU and Δ8°GU : 8° gloss value
- ΔE99o : ΔE99o (DIN 99o) color difference equation
- Greyscale (ISO A105) : Grey Scale (ISO 105-A05)
- Staining ISO 105-A04 : Staining degree (ISO 105-A04)
- FMC2 : FMC-2 color difference equation
- ΔL (FMC 2)
- ΔCr-g (FMC 2)
- ΔCy-b (FMC 2)
- K/S St (ΔE*) : K/S concentration (differential comparison equation (ΔE*ab))
- K/S St (MAX Abs) : K/S concentration (maximum absorption wavelength formula)
- K/S St (Apparent) : K/S concentration (full wavelength formula)
- Blackness (My) and ΔBlackness (My) : Blackness (ISO 18314-3/ DIN 55979)
- Jetness (Mc) and ΔJetness (Mc) : Jetness (ISO 18314-3)
- Undertone (dM) and ΔUndertone (dM) : Undertone (ISO 18314-3)
- None
- UE1 to UE3 : User equation
- UC1 to UC3 : User class

- Press the [Confirmation] key to confirm, and then press [ESC].

The selection is confirmed and the screen returns to the previous screen.

Notes If [ESC] is pressed without pressing the [Confirmation] key, the settings will not be changed, and the screen will return to the <Display cond.> screen.

Instrument Settings

■ Measurement Instrument Option Settings

To set measurement instrument options, select “Instrument setup” from the <Setting> screen.

Operating Procedure

Start the procedure from the measurement screen.

- Press [MENU], and then use [◀] or [▶] to display the <Setting> screen.

Memo To return to the previous screen, press [MENU] or [ESC].

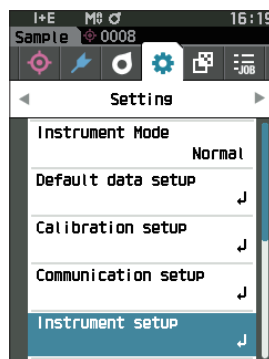

- Use [▲] or [▼] to move the cursor to “Instrument setup”, and then press the [Confirmation] key.

The <Instrument setup> screen is displayed.

- After setting the measurement instrument conditions, press [ESC] to return to the previous screen.



□ User Type

Settings can be protected for each user.

Memo The user type is set to “Administrator” when the instrument is shipped from the factory.

Operating Procedure

Start the procedure from the <Setting> - <Instrument setup> screen.

- 1 Use [▲] or [▼] to move the cursor to “User type”, and then press the [Confirmation] key.

The <User type> setting screen is displayed.



- 2 Use [▲] or [▼] to move the cursor and select the user type.

Settings

- Administrator: All settings can be changed.
- Worker: Some settings cannot be changed.

Memo The operations that workers can perform are as follows.

- “Sample” browsing/measurement/printing/deletion
- “Target” browsing/printing
- Calibration
- Instrument info. displaying
- Changing the user type



Notes Settings for operations that workers can perform can be changed using Configuration Tool CM-CT1.

Memo It is possible to set a password for changing workers to administrators. For details, read P. 121 “Password Setting”.

- 3 Press the [Confirmation] key.

The selection is confirmed and the screen returns to the <Instrument setup> screen.

Notes If [ESC] is pressed without pressing the [Confirmation] key, the settings will not be changed, and the screen will return to the <Instrument setup> screen.

□ Display Language Settings

This instrument allows the display language to be set.

Pressing and holding [MENU] while starting up the instrument also displays the language setting screen.

Memo The language is set to “English” when the instrument is shipped from the factory.

Notes When the backup battery of the instrument has gone dead, the display language is reset to “English”.

Operating Procedure

Start the procedure from the <Setting> - <Instrument setup> screen.

- 1 Use [▲] or [▼] to move the cursor to “Language”, and then press the [Confirmation] key.

The <Language> screen is displayed.



- 2 Use [▲] or [▼] to move the cursor to the desired language.

Settings

- English
- Japanese
- German
- French
- Spanish
- Italian
- Chinese
- Portuguese
- Polish
- Russian
- Turkish

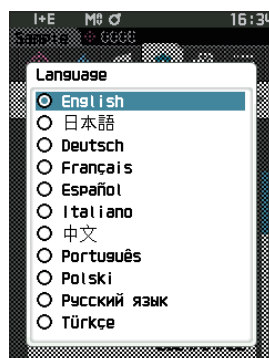

- 3 Press the [Confirmation] key.

The selection is confirmed and the screen returns to the <Instrument setup> screen.

Notes If [ESC] is pressed without pressing the [Confirmation] key, the settings will not be changed, and the screen will return to the <Instrument setup> screen.

□ Date Format Settings

The format of the date displayed on the screen can be changed.

Memo The date format is set to “yyyy/mm/dd” when the instrument is shipped from the factory.

Operating Procedure

Start the procedure from the <Setting> - <Instrument setup> screen.

- 1 Use [▲] or [▼] to move the cursor to “Date format”, and then press the [Confirmation] key.

The <Date format> screen is displayed.



- 2 Use [▲] or [▼] to move the cursor to the desired date format.

Settings

- yyyy/mm/dd : The date is displayed in the format year/month/day order.
- mm/dd/yyyy : The date is displayed in the format of month/day/year.
- dd/mm/yyyy : The date is displayed in the format of day/month/year.

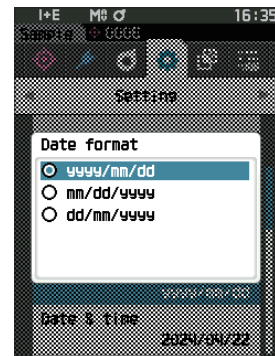

- 3 Press the [Confirmation] key.

The selection is confirmed and the screen returns to the <Instrument setup> screen.

Notes If [ESC] is pressed without pressing the [Confirmation] key, the settings will not be changed, and the screen will return to the <Instrument setup> screen.

□ Clock Settings

This instrument has a built-in clock to record the date and time of measurement. Because the date and time have been set at the factory, there is no need to change these settings under normal conditions. If necessary, however, the date and time settings may be configured.

Operating Procedure

Start the procedure from the <Setting> - <Instrument setup> screen.

- 1 Use [▲] or [▼] to move the cursor to “Date & time”, and then press the [Confirmation] key.

The <Date & time> setting screen is displayed.

- 2 Use [▲] or [▼] to move the cursor to the item to be set, and then press the [Confirmation] key.

The cursor color turns to blue and ▲ and ▼ are displayed above and below the cursor.

- 3 Use [▲] or [▼] to change the value.

Settings

- Year : 2000 to 2099
- Month : 1 to 12
- Day : 1 to 28, 29, 30 or 31 (varies with selected month/year)
- Hour : 0 to 23
- Minute : 0 to 59
- The value increases/decreases by one with each button press.
- Holding down [▲] or [▼] increases/decreases the value by one continuously.
- Use [◀] or [▶] to move between digits.

- 4 Press the [Confirmation] key.

The setting is confirmed.

Notes If [ESC] is pressed without pressing the [Confirmation] key, the settings will not be changed.

- 5 Repeat Steps 2 to 4 for each of the date (Year/ Month/Day) and time (Hour:Minute) parameters.

- 6 After all settings have been configured, use [▲] or [▼] to move the cursor to “OK”, and then press the [Confirmation] key.

The selection is confirmed and the screen returns to the <Instrument setup> screen.

Notes If [ESC] is pressed without pressing the [Confirmation] key, the settings will not be changed and the screen will return to the <Instrument setup> screen.

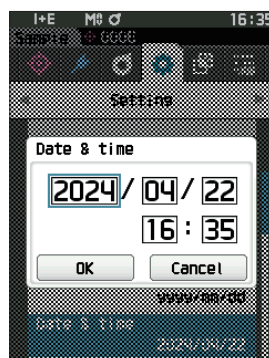

□ Screen Brightness

The brightness of the LCD can be set in five levels. Selecting a darker level is effective for power saving.

Memo Screen brightness is set to “3 (Standard)” when the instrument is shipped from the factory.

Operating Procedure

Start the procedure from the <Setting> - <Instrument setup> screen.

- 1 Use [▲] or [▼] to move the cursor to “Brightness”, and then press the [Confirmation] key.

The <Brightness> setting screen is displayed.

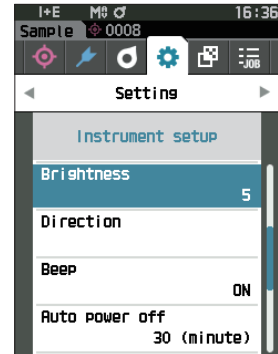

- 2 Use [▲] or [▼] to move the cursor to the desired brightness.

Settings

- 5 (Light)
- 4
- 3 (Standard)
- 2
- 1 (Dark)

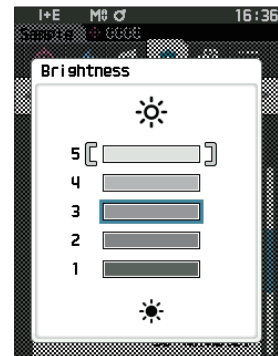

- 3 Press the [Confirmation] key.

The selection is confirmed and the screen returns to the <Instrument setup> screen.

Notes If [ESC] is pressed without pressing the [Confirmation] key, the settings will not be changed, and the screen will return to the <Instrument setup> screen.

□ LCD Screen Display Orientation

Depending on how the instrument is held, the display may be more visible upside-down. This function allows the display to be set to a different orientation in such instances.

Operating Procedure

Start the procedure from the <Setting> - <Instrument setup> screen.

- 1 Use [▲] or [▼] to move the cursor to “Direction”, and then press the [Confirmation] key.

The display will flip upside-down and return to the <Instrument setup> screen.

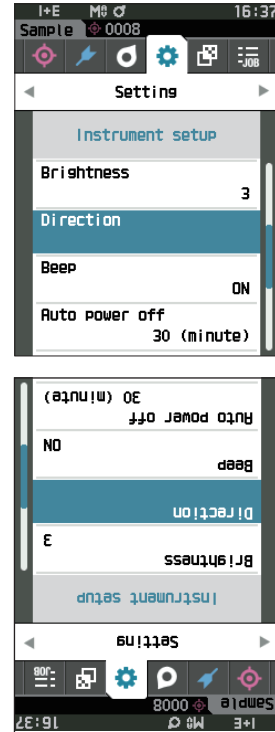

□ Beep

Operation sounds can be set to ON or OFF.

Memo The “Beep” setting is set to “ON” when the instrument is shipped from the factory.

Operating Procedure

Start the procedure from the <Setting> - <Instrument setup> screen.

- 1 Use [▲] or [▼] to move the cursor to “Beep”, and then press the [Confirmation] key.

The <Beep> setting screen is displayed.

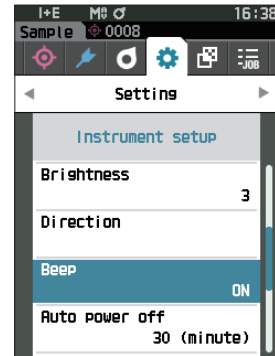

- 2 Use [▲] or [▼] to move the cursor to select ON or OFF.

Settings

- OFF
- ON (Standard)



- 3 Press the [Confirmation] key.

The selection is confirmed and the screen returns to the <Instrument setup> screen.

Notes If [ESC] is pressed without pressing the [Confirmation] key, the settings will not be changed, and the screen will return to the <Instrument setup> screen.

□ Auto Power Off

The amount of time before switching the power off can be set.

Memo Auto power off is set to “30 (minutes)” when the instrument is shipped from the factory.

Operating Procedure

Start the procedure from the <Setting> - <Instrument setup> screen.

- 1 Use [▲] or [▼] to move the cursor to “Auto power off”, and then press the [Confirmation] key.

The <Auto power off> setting screen is displayed.

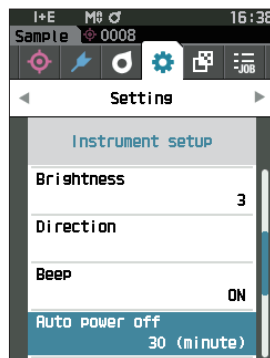

- 2 Use [◀], [▶], [▲], or [▼] to change the value.

Settings

○ 00 to 60 minutes

Memo Setting to “00” minutes will change the setting to “Do not power off”.

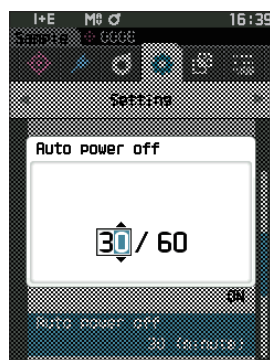

- 3 Press the [Confirmation] key.

The selection is confirmed and the screen returns to the <Instrument setup> screen.

Notes If [ESC] is pressed without pressing the [Confirmation] key, the settings will not be changed, and the screen will return to the <Instrument setup> screen.

□ Password Setting

The password required for changing the user type from a worker to an administrator can be configured in the instrument setup.

Operating Procedure

Start the procedure from the <Setting> - <Instrument setup> screen.

- 1 Use [▲] or [▼] to move the cursor to “Password Setting”, and then press the [Confirmation] key.

The <Password Setting> screen is displayed.

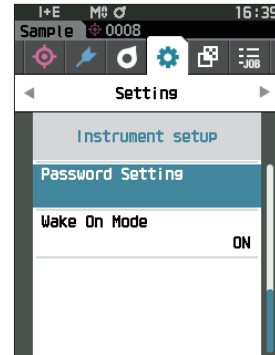

- 2 Use [◀], [▶], [▲], or [▼] to set the password.
Settings

8 digits (Initial value “00000000”: No set password)

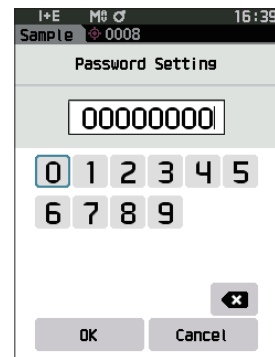

- 3 Press the [Confirmation] key.

The selection is confirmed and the screen returns to the <Measurement setup> screen.

Notes If [ESC] is pressed without pressing the [Confirmation] key, the settings will not be changed and the screen will return to the <Measurement setup> screen.

□ Wake On Mode Settings

Wake On Mode allows the instrument to be turned ON and OFF via communication.

When Wake On Mode is turned ON, the power can be turned ON from the power OFF state without pressing the instrument's power switch by connecting a USB Type-C cable (Power Delivery compatible, 15 W or more).

Memo Wake On Mode is set to "OFF" when the instrument is shipped from the factory.

Notes When using Wake On Mode with the instrument connected via the wireless communication function, use the AC adapter or USB bus power.

Operating Procedure

Start the procedure from the <Setting> - <Instrument setup> screen.

- 1 Use [▲] or [▼] to move the cursor to "Wake On Mode", and then press the [Confirmation] key.

The <Wake On Mode> settings screen is displayed.

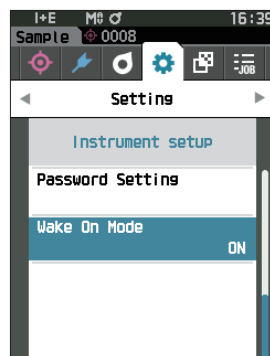

- 2 Use [▲] or [▼] to move the cursor to select ON or OFF.

Settings

- OFF (Standard)
- ON



- 3 Press the [Confirmation] key.

The selection is confirmed and the screen returns to the <Instrument setup> screen.

Notes If [ESC] is pressed without pressing the [Confirmation] key, the settings will not be changed, and the screen will return to the <Instrument setup> screen.

Chapter 4

Other Functions

Connecting to an External Device.....	125
⊙ Connecting to a Computer	125
● Connecting via USB Cable	126
● Connecting Via Wireless LAN/Bluetooth	127
■ Communication Setup (When Using Bluetooth).....	128
■ Communication Setup (When Using Wireless LAN Function: Ad Hoc).....	131
■ Communication Setup (When Using Wireless LAN Function: Infrastructure).....	133
⊙ Connecting to a Printer/Barcode Reader... ..	135
○ Instrument Preparation	136
System Settings	141
■ Calibration Setup	141
■ Displaying Diagnosis Info.	146
■ Displaying the Instrument Information	147
■ Displaying the Wavelength Analysis & Adjustment (WAA) Information.....	148
■ JOB Function	149

Connecting to an External Device

This instrument includes a USB connection terminal and a wireless communication function (when the optional wireless LAN/Bluetooth module is attached). The USB cable (IF-A45 or IF-A28) or wireless LAN/Bluetooth module CM-A300 can be used to connect the instrument to a computer to send data, or Bluetooth communication can be used to connect the instrument to a printer, allowing for printing.

Notes When the instrument is exposed to strong external static electricity or is affected by ambient interference during communication with an external device, the communication may be interrupted. In this case, turn the power OFF and then turn it ON again.

Connecting to a Computer

There are two methods for connecting the instrument to a computer: connecting using the USB cable or via the Instrument's wireless communication function.

Notes

- To use the instrument's wireless communication function to connect to a computer with wireless LAN or Bluetooth communication capabilities, the optional wireless LAN/Bluetooth module CM-A300 must be correctly connected to the instrument and a wireless LAN or Bluetooth communication channel must be opened through the computer's utilities function.
- A simultaneous connection via the USB cable and the wireless communication function is not possible.

Memo

- When connected to a computer, the wireless communication or the wired communication mark is displayed on the LCD screen (refer to P. 19 "Status bar"), and the measurement button and operation keys on the instrument are disabled.
- If a command to enable the measuring button is sent from the computer, measurement will be possible by pressing the measurement button on the instrument. Note that, at this time, sample is transferred to the computer without being stored in the instrument memory.
- To connect the instrument to a computer, use of software that enables connection and operation of the instrument is recommended.

● Connecting via USB Cable

Connect the instrument to a computer with the USB cable IF-A28 (2 m) or USB Type-C cable (2 m) IF-A45.

Notes

- To connect the instrument to a computer, the dedicated USB driver must be installed. The necessary drivers will be installed automatically. To install the drivers manually, use the drivers included with the software (such as the optional Color Data Software SpectraMagic NX2).
- The instrument can be powered through the USB cable. (The battery must always be installed.)
- When power is being supplied via USB, the charging lamp on the instrument's panel will light up orange while charging. When charging is complete, the lamp will turn blue.
- Firmly connect the USB connector plug in the correct orientation.
- When connecting/disconnecting the USB cable, be sure to hold the connector plug. Do not pull on or forcibly bend the cable. Otherwise, wire breakage may result.
- Connect the instrument using a cable with a suitable length. Putting tension on the cable may cause connection failure or wire breakage.
- Firmly push in the USB cable connector that matches the shape of the port (connection terminal) until it can go in no further.

Memo

The USB communication port of the instrument conforms to USB 2.0.

Operating Procedure

- 1 **Open the connector's protective cover, and connect your USB cable's plug to the USB port on the instrument.**

- ◆ Fully insert the connector and ensure the connection is secure.

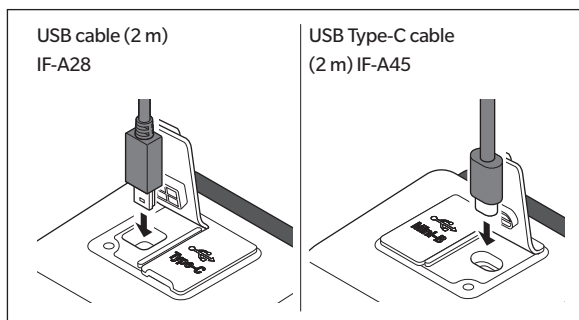

- 2 **Connect the A connector of the USB cable to the USB port on the computer.**

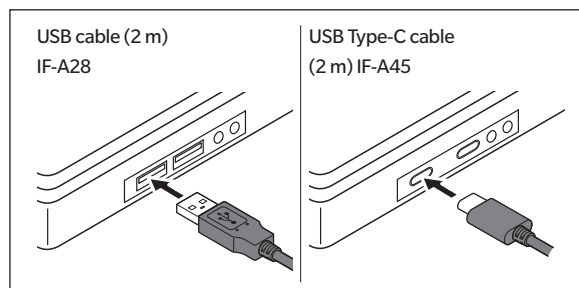

Set the ON/OFF switch for the USB connection in the onscreen settings menu.

- 3 **Turn the wireless communication setting to "OFF".**
 - 3-1 **Start the procedure from the <Setting> - <Communication setup> screen.**

Use [▲] or [▼] to move the cursor to "Wireless Setting", and then press the [Confirmation] key.

The <Wireless Setting> screen is displayed.
 - 3-2 **Use [▲] or [▼] to move the cursor to "OFF", and then press the [Confirmation] key.**
- 4 **Turn the instrument power ON.**
 - ◆ When installation of a USB driver is prompted, specify the USB driver included with your PC software to complete the installation.

● Connecting Via Wireless LAN/Bluetooth

Connect the instrument to a computer with wireless LAN or Bluetooth communication capabilities using the optional wireless LAN/Bluetooth module.

- Notes**
- The instrument's Bluetooth function enables data communication with a connected computer and printing from a Bluetooth printer. Connecting to both a computer and a printer/barcode reader at the same time, however, is not possible.
 - A simultaneous connection via the USB cable and the wireless communication function is not possible. Should both connections be established at the same time, priority will be given to the connection via USB cable.

Memo To connect the instrument to a computer via the wireless LAN/Bluetooth function, appropriate preparations for wireless LAN/Bluetooth communication must be performed in advance for both the instrument and the computer.

○ Instrument Preparation

Connect the optional wireless LAN/Bluetooth module CM-A300.

Use Configuration Tool CM-CT1 to configure the wireless communication settings, and then turn the instrument's wireless communication function ON.

• Connecting the Wireless LAN/Bluetooth Module

Operating Procedure

1 Slide open the instrument's battery cover and attach the wireless LAN/Bluetooth module.

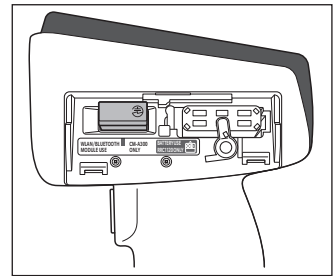
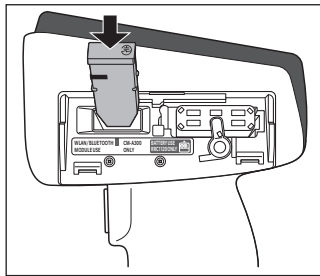
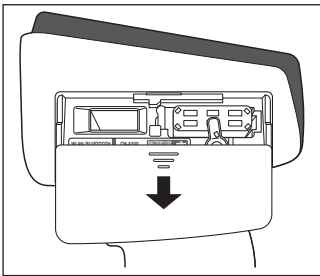

- Notes** When inserting the wireless LAN/Bluetooth module, please note that the module will be slightly loose. Pushing forcibly on the module may damage the connector if the module and the connector on the instrument are not aligned correctly. The module and the connector on the instrument will be aligned correctly if the orange line on the side of the module is no longer visible when the module is dropped into the slot. Push the module in from this position until it clicks (approx. 1 mm).

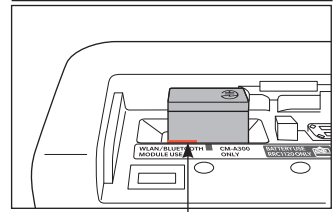

Push in the module until the orange line is no longer visible.

2 Slide the battery cover to close it.

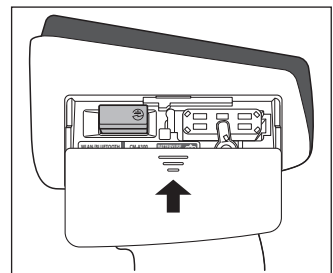

Communication Setup (When Using Bluetooth)

Select the Bluetooth function and configure the meter PIN code.

Operating Procedure

Start the procedure from the measurement screen.

- 1 Press [MENU], and then use [◀] or [▶] to display the <Setting> screen.

Memo To return to the previous screen, press [MENU] or [ESC].

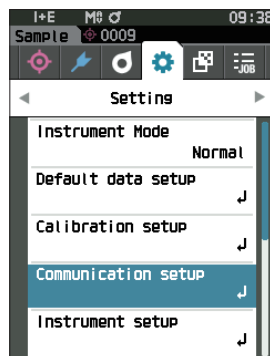

- 2 Use [▲] or [▼] to move the cursor to “Communication setup”, and then press the [Confirmation] key.

The <Communication setup> screen is displayed.



Bluetooth Function Settings

Memo The wireless communication function is set to “OFF” when the instrument is shipped from the factory.

Operating Procedure

Start the procedure from the <Setting> - <Communication setup> screen.

- 1 Use [▲] or [▼] to move the cursor to “Wireless Setting”, and then press the [Confirmation] key.
The <Wireless Setting> screen is displayed.



2 Use [▲] or [▼] to move the cursor to “Bluetooth”, and then press the [Confirmation] key.

When set to “Bluetooth”, the instrument’s Bluetooth function is turned ON and the display will return to the <Communication setup> screen. The Bluetooth icon will be displayed in the status bar.

To configure the Bluetooth PIN code, go to step 3.

Memo The Bluetooth PIN code can also be set using Configuration Tool CM-CT1. For details, refer to the instruction manual of the CM-CT1.

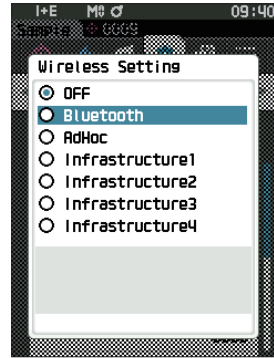

3 Use [▲] or [▼] to move the cursor to “Meter PIN code”, and then press the [Confirmation] key.

The <PIN code setting> screen is displayed.

- The initial personal identification number (PIN) code is “0000”.



4 Use [▲], [▼], [◀], or [▶] to select the value for the PIN code, and then press the [Confirmation] key to input each value.

The PIN should consist of between four and eight numbers (0 to 9).

5 After inputting the value, move the cursor to [OK] and press the [Confirmation] key.

The display will return to the <Communication setup> screen.

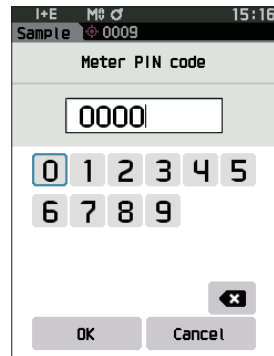

○ Connecting to a Computer

With the computer as a host, a connection to the instrument can be established using Bluetooth communication.

Operating Procedure

- 1 **Verify that the instrument power has been turned ON.**
- 2 **Open the Bluetooth and device settings screen on your computer.**

Notes If your computer uses Windows® 11, go to [Start] > [Settings] > [Bluetooth & devices] > [Devices] and change the device detection setting from “Default” to “Advanced”.

- 3 **Search for nearby Bluetooth devices, and select “CM17d_XXXXXXXX” from the list of displayed devices. (xxxxxxxx indicates the serial number. For the CM-16d, select “CM16d_xxxxxxxx”.)**
- 4 **Enter the PIN code for the instrument (refer to step 4 on P. 129) on the computer.**
- 5 **Open the Bluetooth serial port to connections.**
Once the connection has been established, the “Communication ON” icon will be displayed in the status bar on the instrument.

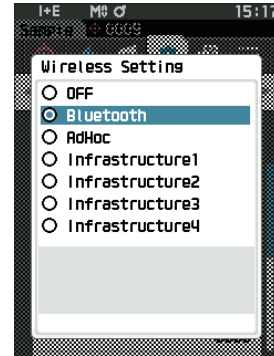

■ Communication Setup (When Using Wireless LAN Function: Ad Hoc)

First, register the IP address and authentication key information to the instrument using Configuration Tool CM-CT1. For details, refer to the instruction manual of the CM-CT1.

Memo Information such as the IP address registered to the instrument can be viewed on the instrument's <Setting> - <Communication setup> - <WLAN Info.> screen.

Next, select "Ad Hoc" for the wireless LAN function to connect to your computer.

Operating Procedure

Start the procedure from the measurement screen.

- 1 Press [MENU], and then use [◀] or [▶] to display the <Setting> screen.

Memo To return to the previous screen, press [MENU] or [ESC].

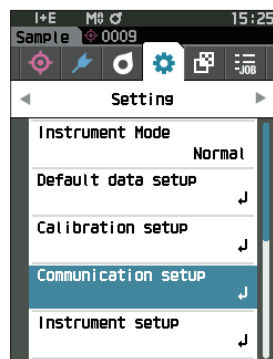

- 2 Use [▲] or [▼] to move the cursor to "Communication setup", and then press the [Confirmation] key.

The <Communication setup> screen is displayed.



□ Wireless LAN Function: Ad Hoc Settings

Memo The wireless communication function is set to “OFF” when the instrument is shipped from the factory.

Operating Procedure

Start the procedure from the <Setting> - <Communication setup> screen.

- 1 Use [▲] or [▼] to move the cursor to “Wireless Setting”, and then press the [Confirmation] key.

The <Wireless Setting> screen is displayed.



- 2 Use [▲] or [▼] to move the cursor to “AdHoc”, and then press the [Confirmation] key.

When set to “AdHoc”, the instrument’s wireless LAN function is turned ON and the display will return to the <Communication setup> screen. The wireless LAN icon will be displayed in the status bar.

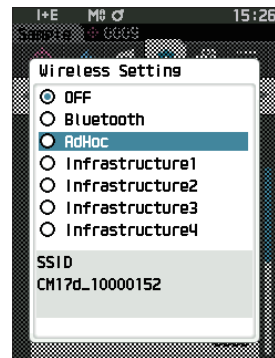

○ Connecting to a Computer

With the computer as a host, a connection to the instrument can be established using wireless LAN communication.

Operating Procedure

- 1 Verify that the instrument power has been turned ON.
- 2 Verify that the wireless LAN function on the instrument has been turned ON.
- 3 Open the available network screen on your computer.
- 4 The connection destination is displayed with the instrument name and serial number as ID. Select it and click on it.
- 5 On your computer, connect the instrument to the wireless LAN network using the optional Color Data Software SpectraMagic NX2. For details, refer to the instruction manual of SpectraMagic NX2.

Once the connection has been established, the “Communication ON” icon will be displayed in the status bar on the instrument.

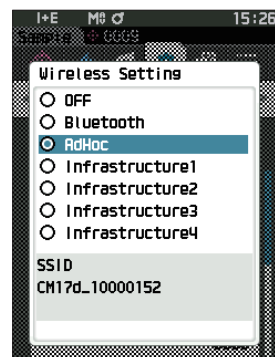

■ Communication Setup (When Using Wireless LAN Function: Infrastructure)

First, register the access point information to the instrument using Configuration Tool CM-CT1. For details, refer to the instruction manual of the CM-CT1.

Memo Information such as the access point and IP address registered to the instrument can be viewed on the instrument's <Setting> - <Communication setup> - <WLAN Info.> screen.

Next, select "Infrastructure" for the wireless LAN function to connect to the computer.

Operating Procedure

Start the procedure from the measurement screen.

- 1 Press [MENU], and then use [◀] or [▶] to display the <Setting> screen.

Memo To return to the previous screen, press [MENU] or [ESC].

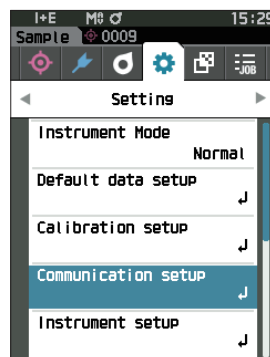

- 2 Use [▲] or [▼] to move the cursor to "Communication setup", and then press the [Confirmation] key.

The <Communication setup> screen is displayed.



□ Wireless LAN Function: Infrastructure Settings

Memo The wireless communication function is set to “OFF” when the instrument is shipped from the factory.

Operating Procedure

Start the procedure from the <Setting> - <Communication setup> screen.

- 1 Use [▲] or [▼] to move the cursor to “Wireless Setting”, and then press the [Confirmation] key.

The <Wireless Setting> screen is displayed.



- 2 Use [▲] or [▼] to move the cursor to one of “Infrastructure1” to “Infrastructure4”, and then press the [Confirmation] key.

When set to “Infrastructure”, the connection between the device and the access point is established, the instrument’s wireless LAN function is turned ON, and the display will return to the <Communication setup> screen. The wireless LAN icon will be displayed in the status bar.

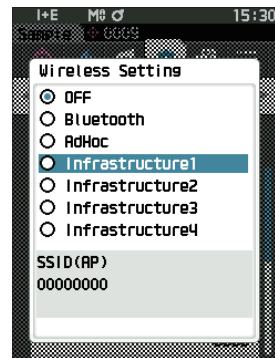

○ Connecting to a Computer

With the computer as a host, a connection to the instrument can be established using wireless LAN communication.

Operating Procedure

- 1 Verify that the instrument power has been turned ON.
- 2 Verify that the wireless LAN function on the instrument has been turned ON.
- 3 Verify that the connection between the computer and the access point has been established.
- 4 On your computer, connect the instrument to the wireless LAN network using the optional Color Data Software SpectraMagic NX2. For details, refer to the instruction manual of SpectraMagic NX2.

Once the connection has been established, the “Communication ON” icon will be displayed in the status bar on the instrument.

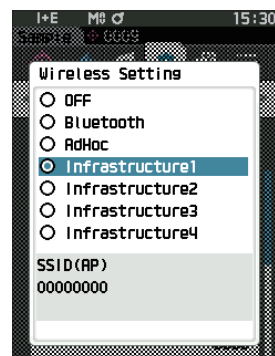

○ Connecting to a Printer/Barcode Reader

Connecting the instrument to a printer or barcode reader via the Bluetooth function enables printing of various data such as measurement results or scanning of names for data to save to the instrument.

- Notes**
- **With the optional wireless LAN/Bluetooth module CM-A300 installed, the Bluetooth function of this instrument enables data communication to a computer, data printing to the Bluetooth printer, and reading of data names from a barcode reader. However, connecting to both the Bluetooth module and a computer is not possible.**
 - **Printing is possible at distances up to 10 m, but the distance at which operation can be performed properly depends on the wireless environment around the device.**
 - **The instrument can only output text to the printer. Note that even if spectral graphs, color difference graphs, or other graphics are selected in the display type of the instrument, no graph will be printed.**

- Memo**
- To connect the instrument to a printer or barcode reader via the Bluetooth function, appropriate preparations for Bluetooth communication must be performed in advance for both the instrument and the printer or barcode reader.
 - Bluetooth communication with the instrument supports the Serial Port Profile (SPP).
Note that some printers and barcode readers may not operate correctly even if SPP is supported. Use equipment recommended by a KONICA MINOLTA-authorized service facility.

○ Printer/Barcode Reader Preparation

The following section describes the preparations required for ensuring that the instrument recognizes the bluetooth printer or a barcode reader as a Bluetooth device.

- Notes** This section describes general procedures. For more information, please refer to the instruction manuals included with the Bluetooth printer and the barcode reader.

Operating Procedure

- 1 Ensure use of the Bluetooth printer / barcode reader is possible.**
 - ◆ Verify that the printer/barcode reader communication mode is set to Bluetooth. In addition, charge the battery and load printer paper as required.

- 2 Verify the Bluetooth address and PIN code of the printer/barcode reader.**

Instrument Preparation

Connecting the Bluetooth module to the instrument, and turn ON the instrument's Bluetooth function. (Refer to P. 127.)

Memo The Bluetooth address and Bluetooth PIN code can also be set using Configuration Tool CM-CT1. For details, refer to the instruction manual of the CM-CT1.

Registering a Bluetooth Address

Operating Procedure

Start the procedure from the <Setting> - <Communication setup> screen.

- 1 Use [▲] or [▼] to move the cursor to "Printer address" or "Scanner address", and then press the [Confirmation] key.

The <Printer address> / <Scanner address> screen is displayed.

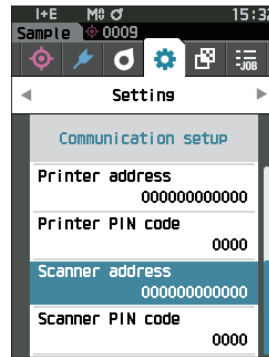
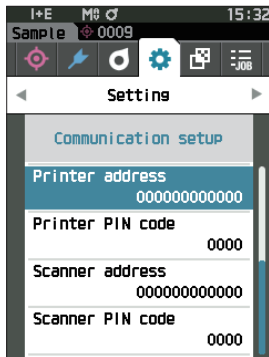

- 2 Enter the address of the Bluetooth device to be connected.

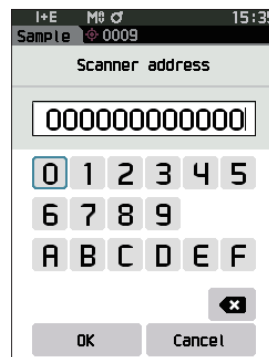
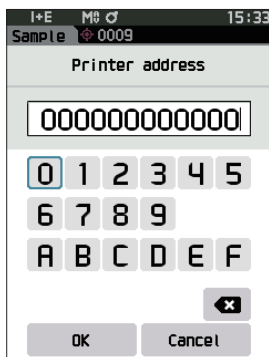

- 3 After inputting the characters, move the cursor to [OK] and press the [Confirmation] key.

The printer/barcode reader will be registered as an I/O device for the instrument, and the display will return to the <Communication setup> screen.

Memo If [ESC] is pressed during configuration, or if the cursor is moved to "Cancel" and the [Confirmation] key is pressed, the settings will not be changed and the screen will return to the <Communication setup> screen.

□ Configuring PIN Code

Enter the PIN set for the printer/barcode reader (already confirmed).

Operating Procedure

Start the procedure from the <Setting> - <Communication setup> screen.

- 1 Use [▲] or [▼] to move the cursor to “Printer PIN code” or “Scanner PIN code”, and then press the [Confirmation] key.

- The initial personal identification number (PIN) code is “0000”.

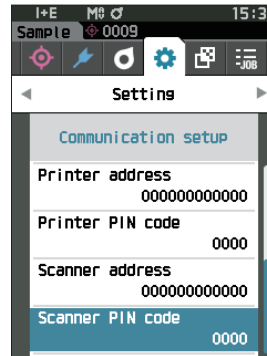
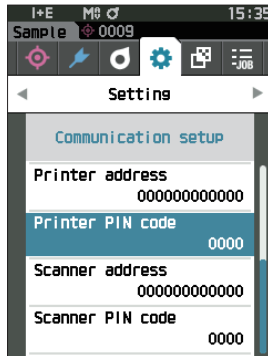

- 2 Use [▲], [▼], [◀], or [▶] to enter the PIN code.

- The PIN should consist of between four and eight numbers (0 to 9).

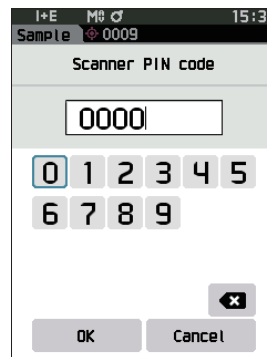
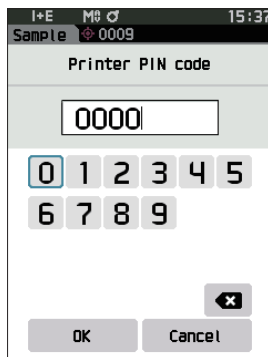

- 3 After inputting the value, move the cursor to [OK] and press the [Confirmation] key.

The printer/barcode reader will be connectable as an I/O device for the instrument, and the display will return to the <Communication setup> screen.

Memo If [ESC] is pressed during configuration, or if the cursor is moved to “Cancel” and the [Confirmation] key is pressed, the settings will not be changed and the screen will return to the <Communication setup> screen.

□ Printing Data

Print the sample or target data with the printer.

- Notes**
- The instrument must be connected to the printer in advance.
 - The instrument can only output text to the printer. Note that even if spectral graphs, color difference graphs, or other graphics are selected in the display type of the instrument, no graph will be printed.

Operating Procedure

Start the procedure from the <Target> or <Sample> screen.

- 1 To print the target and sample display, press the [MENU] key with the data to be printed displayed. The <Target menu> screen or the <Sample menu> screen will be displayed.



- 2 Use [▲] or [▼] to move the cursor to "Print data".

Press the [Confirmation] key to display the <Print> screen and print the data from the connected printer.

- When the printing is complete, the screen returns to the <Target> / <Sample> screen.

□ Auto Print

Measurement results can be automatically printed for every measurement.

- Notes**
- The instrument must be connected to the printer in advance.
 - The instrument can only output text to the printer. Note that even if spectral graphs, color difference graphs, or other graphics are selected in the display type of the instrument, no graph will be printed.

Memo / Auto print is set to “OFF” when the instrument is shipped from the factory.

Operating Procedure

Start the procedure from the <Setting> - <Communication setup> screen.

- 1 Use [▲] or [▼] to move the cursor to “Auto print”, and then press the [Confirmation] key.

The <Auto print> screen is displayed.



- 2 Use [▲] or [▼] to move the cursor to “ON”, and then press the [Confirmation] key.

The Auto Print function will turn ON, and printing will be performed every time measurement is performed. After the settings have been configured, the display will return to the <Communication setup> screen.

Print Example 1

Display type set to “Spectral Graph”

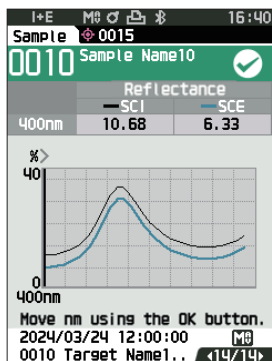

```
S/N 10000151
SAMPLE010 PASS
Sample Name10

          SCI
400nm 10.88 560nm 21.57
410nm 10.91 570nm 19.34
420nm 11.24 580nm 17.54
430nm 11.79 590nm 16.16
440nm 12.62 600nm 15.14
450nm 13.89 610nm 14.40
460nm 15.77 620nm 13.88
470nm 18.30 630nm 13.59
480nm 22.25 640nm 13.48
490nm 26.72 650nm 13.54
500nm 31.32 660nm 13.80
510nm 33.96 670nm 14.26
520nm 33.51 680nm 14.93
530nm 30.98 690nm 15.84
540nm 27.88 700nm 17.17
550nm 24.37
```

```
          SCE
4400nm 6.33 560nm 17.4
410nm 6.64 570nm 15.21
420nm 7.03 580nm 13.42
430nm 7.59 590nm 12.04
440nm 8.44 600nm 11.03
450nm 9.72 610nm 10.29
460nm 11.58 620nm 9.78
470nm 14.12 630nm 9.5
480nm 18.11 640nm 9.38
490nm 22.51 650nm 9.46
500nm 27.15 660nm 9.72
510nm 29.8 670nm 10.18
520nm 29.36 680nm 10.86
530nm 26.84 690nm 11.78
540nm 23.54 700nm 13.12
550nm 20.25
2024/03/24 12:00:00 MAV
TARGET0010
Target Name10
```

Print Example 2

Display type set to "Diff. Graph"

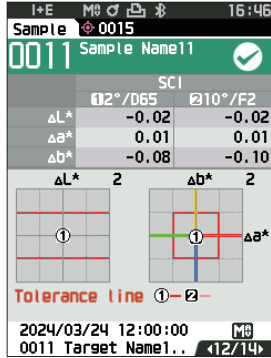

```

S/N 10000151
SAMPLE010 PASS
Sample Name10

      2/D65   10/F2
          SCI
dL*  -0.01  -0.02
da*   0.01   0.01
db*  -0.05  -0.08
dE*ab 0.06   0.08
MI    0.03   0.03
          SCE
dL*  -0.01  -0.02
da*  -0.00  -0.00
db*  -0.08  -0.11
dE*ab 0.08   0.11
MI    0.03   0.03
2024/03/24 12:00:00 (MAV)
TARGET0010
Target Name10
    
```

Memo / If the color difference result is "Fail", an "x" will be printed after the value.
 If the value approaches the tolerance, "w" is appended after the value.

Print Example 3

Display type set to "Abs. & Diff."

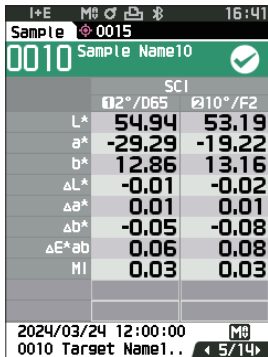

```

S/N 10000151
SAMPLE010 PASS
Sample Name10

      2/D65   10/F2
          SCI
L*   54.94   53.19
a*  -29.29  -19.22
b*   12.86   13.16
dL*  -0.01  -0.02
da*   0.01   0.01
db*  -0.05  -0.08
dE*ab 0.06   0.08
MI    0.03   0.03
          SCE
L*   50.38   48.37
a*  -34.27  -22.58
b*   15.23   15.87
dL*  -0.01  -0.02
da*  -0.00  -0.00
db*  -0.08  -0.11
dE*ab 0.08   0.11
MI    0.03   0.03
2024/03/24 12:00:00 (MAV)
TARGET0010
Target Name10
    
```

Print Example 4

Opacity measurement

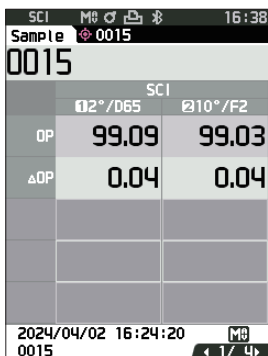

```

S/N 10000151
SAMPLE0015 ---

      2/D65   10/F2
          SCI
OP   99.09   99.03
dOP  0.04    0.04
2024/04/02 16:24:20 (MAV)
TARGET0015
    
```

Items marked with (MAV) are not displayed with the CM-16d.

System Settings

This section explains how to configure calibration, how to display the instrument diagnosis info., and how to display the instrument info.

Operating Procedure

Start the procedure from the measurement screen.

- 1 Press [MENU], and then use [◀] or [▶] to display the <Setting> screen.

Memo To return to the previous screen, press [MENU] or [ESC].

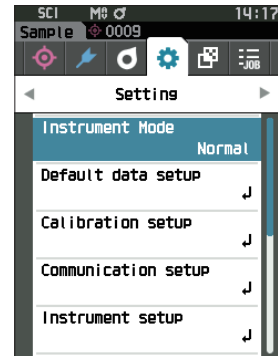

Calibration Setup

Configure the instrument calibration settings.

Operating Procedure

Start the procedure from the <Setting> screen.

- 1 Use [▲] or [▼] to move the cursor to “Calibration setup”, and then press the [Confirmation] key.

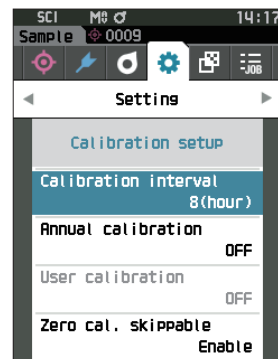
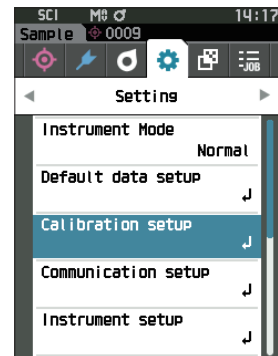

□ Calibration Interval Messages

If the instrument has not been used for an extended period of time since the previous measurement, a message prompting white calibration will appear after start-up and before measurement. The time interval between the previous calibration and when the message is displayed can be configured.

Memo The interval until the calibration is displayed is set to “8 hours” when the instrument is shipped from the factory.

Operating Procedure

Start the procedure from the <Calibration setup> screen.

- 1 Use [▲] or [▼] to move the cursor to “Calibration interval”, and then press the [Confirmation] key.

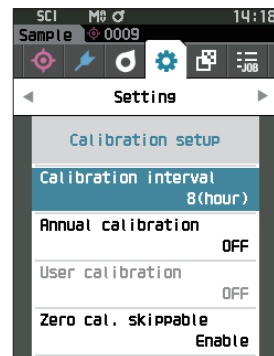

- 2 ▲ and ▼ will be displayed above and below the numbers representing the time until the message is displayed. Use [▲] or [▼] to specify a value.

Settings

- 1 to 24 h: Set the time interval between the previous calibration and when the message should be displayed to between 1 and 24 hours.

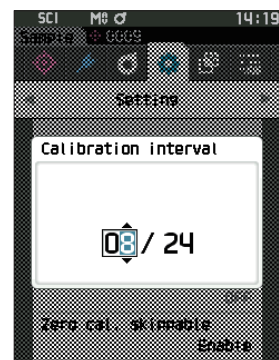

- 3 Press the [Confirmation] key.

The selection is confirmed and the screen returns to the <Calibration setup> screen.

Notes If [ESC] is pressed without pressing the [Confirmation] key, the settings will not be changed and the screen will return to the <Calibration setup> screen.

□ Annual Calibration Messages

As the time for periodic calibration approaches, the instrument shows a message reading “Regularly scheduled device calibration is required. Please contact the nearest service center.” at start-up to recommend annual service recalibration.

The annual calibration message can be set to be shown or to be hidden when the recommended recalibration time comes.

Notes Regardless of displaying annual calibration message, it is recommended to request regular calibration through our service department.

Memo Display of the annual calibration message is set to “ON (Display)” when the instrument is shipped from the factory.

Operating Procedure

Start the procedure from the <Setting> - <Calibration setup> screen.

1 Press [MENU].

The <Annual calibration> screen is displayed.

Settings

- OFF : The message about annual calibration will not be displayed.
- ON : The message about annual calibration will be displayed.

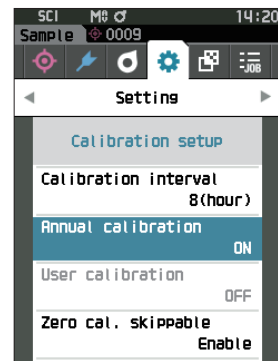

2 Use [▲] or [▼] to move the cursor to select “OFF” or “ON”.

Memo If the annual calibration notification message is set to ON, the annual calibration message will be displayed as the specified day nears. The date of the next calibration is specified upon initial startup or during KONICA MINOLTA calibration service (or maintenance) and cannot be changed.

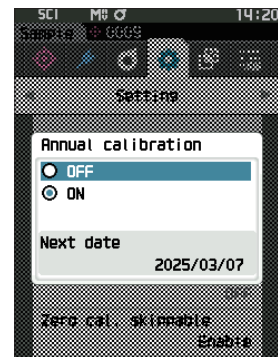

3 Press the [Confirmation] key.

The selection is confirmed and the screen returns to the <Calibration setup> screen.

Notes If [ESC] is pressed without pressing the [Confirmation] key, the settings will not be changed and the screen will return to the <Setting> screen.

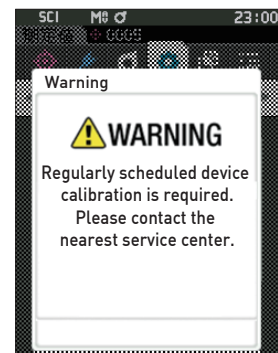

□ User Calibration

You can perform calibration by using your own reference plate and calibration data instead of white calibration. The calibration data for user calibration can be specified by connecting the instrument to a computer and using the optional Color Data Software SpectraMagic NX2. Users can select whether to use the user calibration data for measurement.

Operating Procedure

Start the procedure from the <Setting> - <Calibration setup> screen.

1 Press [MENU].

The <User calibration> screen is displayed.

Settings

- OFF : User calibration cannot be performed.
- ON : User calibration can be performed.

2 Use [▲] or [▼] to move the cursor to select “OFF” or “ON”.

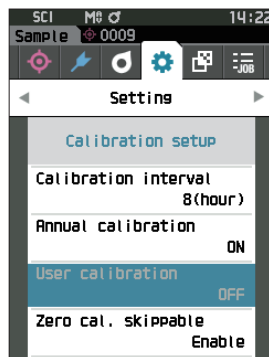

3 Press the [Confirmation] key.

The selection is confirmed and the screen returns to the <Calibration setup> screen.

Notes If [ESC] is pressed without pressing the [Confirmation] key, the settings will not be changed and the screen will return to the <Calibration setup> screen.

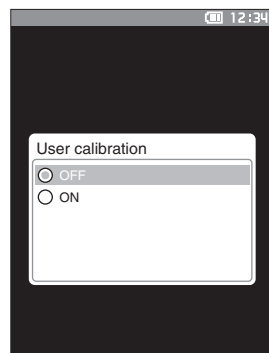

□ Zero Calibration Skip

When shipped from the factory, “Calibration (Excluding Zero Cal.)” is enabled on the <Calibration> screen. If configuring to ensure that zero calibration is performed, disable this function.

Memo Zero calculation skippable is set to “Disable” (performing zero calibration) when the instrument is shipped from the factory.

Notes • When using the MAV target mask (with glass), it is necessary to set “Zero cal. skippable” to “Disable” because the amount of stray light tends to fluctuate.

Operating Procedure

Start the procedure from the <Setting> - <Calibration setup> screen.

- 1 Use [▲] or [▼] to move the cursor to “Zero cal. skippable”, and then press the [Confirmation] key.

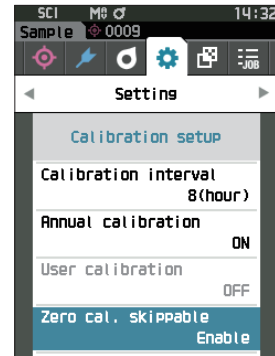

- 2 Use [▲] or [▼] to move the cursor to select “Disable” or “Enable”.



- 3 Press the [Confirmation] key.

The selection is confirmed and the screen returns to the <Calibration setup> screen.

Notes If [ESC] is pressed without pressing the [Confirmation] key, the settings will not be changed and the screen will return to the <Calibration setup> screen.

■ Displaying Diagnosis Info.

The results of the instrument status diagnosis using optional PC software are displayed.

(* Support for this function is planned with optional PC software. It is not currently available.)

Operating Procedure

Start the procedure from the <Setting> screen.

- 1 Use [▲] or [▼] to move the cursor to “Diagnosis info.,” and then press the [Confirmation] key.



- 2 The instrument status is diagnosed and the results are displayed.

Display

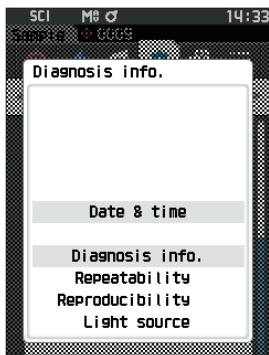

- 3 Press [ESC].

The display will return to the <Setting> screen.

■ Displaying the Instrument Information

Display the product name, version, and serial number of the instrument.

Operating Procedure

Start the procedure from the <Setting> screen.

- 1 Use [▲] or [▼] to move the cursor to “Instrument info.,” and then press the [Confirmation] key.



- 2 The instrument information is displayed.

Display Items

- Product name: Instrument product name
- Version: Instrument firmware version
- Serial No.: Instrument serial number

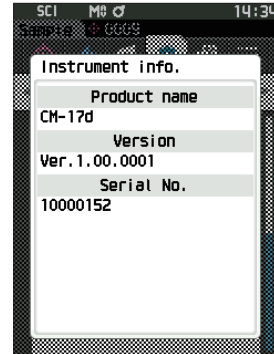

- 3 Press [ESC].

The display will return to the <Setting> screen.

■ Displaying the Wavelength Analysis & Adjustment (WAA) Information

Displays the license status of the wavelength analysis & adjustment (WAA) function. As the time of license expiration approaches, the instrument shows a message recommending license renewal at start-up. The license renewal message can be set to be shown or to be hidden when the time for license renewal comes in the annual calibration message settings (P. 143).

Operating Procedure

Start the procedure from the <Setting> screen.

- 1 Use [▲] or [▼] to move the cursor to “WAA info.,” and then press the [Confirmation] key.



- 2 The instrument information is displayed.

Display Items

- Product name: Instrument product name
- License: Enable/disable license
- Expiration Date: Expiration date of wavelength analysis & adjustment (WAA) function license



- 3 Press [ESC].

The display will return to the <Setting> screen.

JOB Function

Administrators can pre-register to the instrument workflows to be performed by the worker, allowing the worker to perform measurement according to the registered workflow. This selection screen is available when the JOB has been set in advance with the optional Color Data Software SpectraMagic NX2.

- Notes**
- **Communication via USB is recommended when configuring JOB settings using the optional Color Data Software SpectraMagic NX2. Configuration of the JOB function is possible via Bluetooth communication, but transferring settings and images between the computer and the measuring instrument will take time.**
 - **Exiting JOB mode will cause the observation conditions under JOB settings to be reset and the main unit's observation conditions to be restored. As such, if the JOB setting observation conditions differ from the main unit observation conditions, pass/fail results may differ between during JOB execution and after exiting the mode.**

Operating Procedure

Start the procedure from the measurement screen.

- 1 Press [MENU], and then use [◀] or [▶] to display the <JOB> screen.

Memo To return to the previous screen, press [MENU] or [ESC].

- 2 Use [▲] or [▼] to move the cursor to the JOB to be used.

- 3 Follow the on-screen instructions to perform measurement.



- Notes**
- Up to 5 types of JOBS can be registered.
 - Calibration according to the measurement conditions being used within the JOB must be performed in advance. Opacity measurement cannot be performed while in JOB mode.

The operations for the various keys on the instrument are as follows.

- [▲] / [▼] key ... Used to switch the data display type (SCI, SCE, or Pass or Fail).
- [◀] / [▶] key ... Used to select the Option Item.
- [Confirmation] key... Used to execute the Option Item selected by the cursor.
- [Target/Sample] key ...
 Operation step : Disable
 Result step : Disable
- [MENU] key ... Disabled
- [ESC] key ... Used to end a JOB in progress through a warning message. Users can select "YES" or "NO" for the warning. Selecting "YES" will cause the screen to return to the JOB selection screen. Selecting "NO" will maintain the current step.
- Measurement button...
 Operation step : Performs measurement and moves to the next step.
 Result step : Moves to the next step.

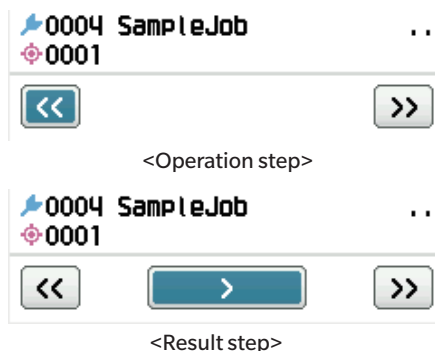

- << ... Moves to the previous step. When returning to the Operation step, the data measured in the Operation step will be discarded, so performing measurement again will be necessary.
- > ... Moves to the next step. This key is not displayed in the Operation step.
- >> ... Moves to the next Operation step.

Chapter 5

Troubleshooting

Message List.....	151
Troubleshooting	154

Message List

Error message: The operation is not correct. Follow the instructions displayed immediately.

ER1_32	There was an error with color measurement device. Restart and try measuring again. If the error occurs, please contact the nearest service center.
ER1_34	There is no xenon output. Restart and try measuring again. If the error occurs again, please contact the nearest service center.
ER1_35	There is no LED output. Restart and try measuring again. If the error occurs again, please contact the nearest service center.
ER1_36	The battery status cannot be obtained. Please contact the nearest service center.
ER1_39	There was an error writing to the memory. Restart and try again. If the error occurs again, please contact the nearest service center.
ER1_40	A memory error has occurred. Please contact the nearest service center.
ER1_41	The USB device is not working. Restart the device. If the error occurs again, please contact the nearest service center.
ER1_42	The USB host is not working. Restart the device. If the error occurs again, please contact the nearest service center.
ER1_43	An error has occurred with the clock IC. Please contact the nearest service center.
ER1_47	Connection to the printer failed. Please check the power and the settings.
ER1_55	The wireless module is not installed. Please check the wireless module is installed.
ER1_56	The wireless module not recognised. Attach the correct wireless module.
ER1_57	Wireless connection failed. Restart the device. Please check the wireless settings.
ER1_58	The Camera for acquiring finder image is not working. Restart the device. If the error occurs again, please contact the nearest service center.
ER1_60	The license for Wavelength Analysis & Adjustment (WAA) has expired. Please contact the nearest service center.
ER1_62	The intensity of light for Wavelength Analysis & Adjustment (WAA) is insufficient. If the error occurs again, please contact the nearest service center.
ER1_63	Wavelength Analysis & Adjustment (WAA) is out of the correction range, the correction is not performed. If the error occurs again, please contact the nearest service center.

Warning: Continued use will result in incorrect operation. Follow the instructions displayed as soon as possible.

ER1_31	The power supply voltage is insufficient. Please charge.
WR1_1	The power supply voltage is low. Please charge.
WR1_3	Xenon output has dropped. Replacement is recommended.
WR1_4	The LED output has dropped. Replacement is recommended.
WR1_7	The battery is low. Replace the battery.
ER1_61	The license expiration for Wavelength Analysis & Adjustment (WAA) is approaching. Please contact the nearest service center.
WR1_11	The intensity of light for Wavelength Analysis & Adjustment(WAA) is decreasing. Replacement is recommended.
WR1_12	Wavelength Analysis & Adjustment (WAA) is out of the temperature specification range, the correction accuracy has decreased.
WR1_13	Wavelength Analysis & Adjustment (WAA) is out of the correction specification range, the correction accuracy has decreased.

Caution: The setting or operation is not correct.

ER1_5	The target mask is wrong.
ER1_15	The target is protected. Refer to P. 72.
ER1_18	The data could not be calculated.
ER1_19	Data is outside the range of guaranteed performance.
ER1_20	The input data is incorrect.
ER1_21	No target was found.
ER1_22	The measurement variation has exceeded the threshold. Try measuring again.
ER1_23	You have reached the maximum number of possible measurements.
ER1_25	Cannot be used in the current mode.
ER1_26	This sample cannot be referenced to the selected target.
ER1_37	During the measurement, the measurement area was changed.
ER1_45	Only administrators can control this function. Refer to P. 113.
ER1_48	The date is incorrect. Refer to P. 116.
ER1_49	The set tolerance range is incorrect. Please check the upper and lower limits. Refer to P. 75, 84.
ER1_59	This operation cannot be used.
WR1_8	Please retry the measurement. Press the measurement button to measure and update to the most recent data.

Display: The flow of operation is displayed. Perform the operation according to the information displayed.

ER1_1	Regularly scheduled device calibration is required. Please contact the nearest service center.	Refer to P. 143.
ER1_2	Regularly scheduled device calibration is approaching. Please contact the nearest service center.	Refer to P. 143.
ER1_3	Perform calibration using the cradle or empty space output.	Refer to P. 38.
ER1_4	Perform zero calibration.	Refer to P. 38.
ER1_6	Please set the instrument on the white calibration plate and calibrate.	Refer to P. 40.
ER1_7	Perform white calibration.	Refer to P. 40.
ER1_8	Configure the white calibration data.	Refer to P. 40.
ER1_12	Please set the instrument on the user calibration plate and calibrate.	Refer to P. 42.
ER1_13	Perform user calibration.	Refer to P. 42.
ER1_14	Configure the user calibration data.	Refer to P. 42.
ER1_16	The device memory is full. Please delete some data to measure.	Refer to P. 44, 56.
ER1_17	Specify at least one.	
ER1_24	Please change the measurement area.	
ER1_38	Please close the viewfinder.	Refer to P. 43.
ER1_50	Calibration is required. Would you like to calibrate now?	Refer to P. 38.
WR1_9	Data is being saved. Please wait until the power turns off.	
WR1_10	Data is being processed. Please wait.	
WR1_2	Calibration is recommended. Would you like to calibrate now?	Refer to P. 38, 142.

Troubleshooting

If an abnormality has occurred with the instrument, take the necessary actions as given in the table below. If the instrument still does not work properly, turn the power OFF and temporarily disconnect the battery. Reinsert the battery and turn the power back ON. If the symptom remains, contact a KONICA MINOLTA-authorized service facility.

Symptom	Check Point	Action
(When battery is not loaded) The instrument does not start up even though the power is ON. (When battery is loaded) The instrument does not start up even though the power is ON, or it turns off immediately.	(When battery is not loaded) Is the instrument correctly connected to a power supply that supports USB Power Delivery (15 W or more)? (When battery is loaded) Has the battery been inserted correctly? Is the battery dead?	(When battery is not loaded) Correctly connect the instrument to a power supply that supports USB Power Delivery (15 W or more). (When battery is loaded) Correctly load the battery and charge the battery by USB Power Delivery (15 W or more) supported power supply or USB bus power.
Measurement cannot be performed even by pressing the measurement button.	Is measurement still in progress?	Wait until the beep indicates that measurement is complete, or verify that the LCD has changed before performing the operation. If the beep does not sound, see P. 119 “Beep”, and check the beep settings.
	Is a screen where measurement is possible displayed?	The measurement button must be pressed while a screen that allows measurement (e.g. Calibration, Target, or Sample screen) is shown.
Measurement results are abnormal.	Is the specimen placed properly?	The measurement results may be affected if measurement light leaks. Set the instrument so that the sample is as close to the target mask surface as possible.
	Is there any foreign material on the surface of the target mask or around the specimen measuring surface?	Measurement results may be affected if foreign matter becomes caught between the specimen and the target mask surface. Clean the specimen surface or the target mask measurement surface according to the specified method.
	Are there marks on the surface of the target mask around the specimen measuring port?	If the sample and the target mask surface are not in contact due to a dent or the like, the measurement results may be affected. To replace the target mask, please contact a KONICA MINOLTA-authorized service facility.
	Is there foreign matter or other dirt adhering to the inside of the integrating sphere?	Foreign matter or dirt larger than several mm may affect the measurement results. Foreign matter and dust inside the integrating sphere can easily scratch the barium sulfate paint on the inside of the sphere. Use a blower to blow off those objects. If such objects cannot be removed with the blower, zero calibration and white calibration may improve performance.
	Is the target mask attached correctly?	Read P. 35 “Attaching/Removing the Target Mask” and attach the target mask correctly.
	Is the correct white calibration plate (white calibration cap) being used?	Perform white calibration using the correct white calibration cap with the same serial number as the instrument.
	Was white calibration performed correctly?	Read P. 40 “White Calibration” and perform white calibration correctly.
	Was zero calibration performed correctly?	Read P. 38 “Zero calibration” and perform zero calibration properly.

Symptom	Check Point	Action
Measurement results fluctuate.	Is the instrument and specimen kept stationary during measurement?	Do not allow the instrument and specimen to move during measurement. Use averaging measurement as needed.
Data cannot be transferred to a computer from the instrument.	Is the USB cable connected correctly?	Properly connect the instrument's USB connecting terminal to the computer's USB port with the USB cable supplied with the instrument.
No commands from the computer are being accepted.	Has wireless LAN or Bluetooth communication been established?	Install and connect the wireless LAN/Bluetooth module correctly.
Printing is not possible.	Has wireless LAN or Bluetooth communication been established?	Install and connect the wireless LAN/Bluetooth module correctly.
Samples and settings are not held in memory and disappear immediately.	The instrument's backup battery may be low immediately after purchase or following a period of prolonged non-use. Turn the instrument ON to charge the backup battery. Under this condition, the backup battery will be fully charged in 20 hours.	The backup battery in the instrument should last 10 years under normal use. If the instrument fails to retain data in memory even after the battery has been fully charged, however, the battery has likely reached the end of its life and requires replacement. To replace the backup battery, please contact a KONICA MINOLTA-authorized service facility.

Chapter 6

Appendix

Wavelength Correction Function (WAA*)	157
Specifications	158
Dimensions	160
User Equation and User Class.....	161

Wavelength Correction Function (WAA*)

Wavelength Correction Function

In spectrophotometers, fluctuations caused by shifts in the wavelength direction (hereinafter referred to as “wavelength shift”) do occur rarely due to unforeseen shocks or temperature, humidity, or other environmental changes in the process of using the instrument.

The wavelength correction function uses our proprietary technology (patent pending)* that detects and corrects wavelength shifts using a bright-line light source installed inside the instrument. In daily use, wavelength shift from the time of purchase (calibration at our factory) can be detected and corrected to maintain high measurement accuracy. In addition, a warning is displayed when an abnormality occurs, helping to prevent measurement errors caused by spectrophotometer abnormalities.

Fluctuations in the reflectance level direction are calibrated by zero calibration (0% spectral reflectance level) and white calibration (100% spectral reflectance level), which are performed prior to measurement using a zero calibration box and white calibration cap.

* Our proprietary wavelength shift correction function is called WAA (Wavelength Analysis & Adjustment).

Spectrophotometer Maintenance

Inspection and calibration services perform maintenance, inspection, and calibration of instruments for measurement in their normal operating environment. If wavelength shift becomes severe, WAA is not sufficient to compensate for it, and the spectrophotometer in use needs to be sent for inspection and calibration services. In addition, fluctuations in the reflectance level direction are calibrated by zero calibration and white calibration performed during startup of the instrument, but grime, dust, and other contaminants in the white calibration plate or instrument can be error factors other than wavelength shift. We recommend that you have the instrument serviced and calibrated to ensure its effective use.

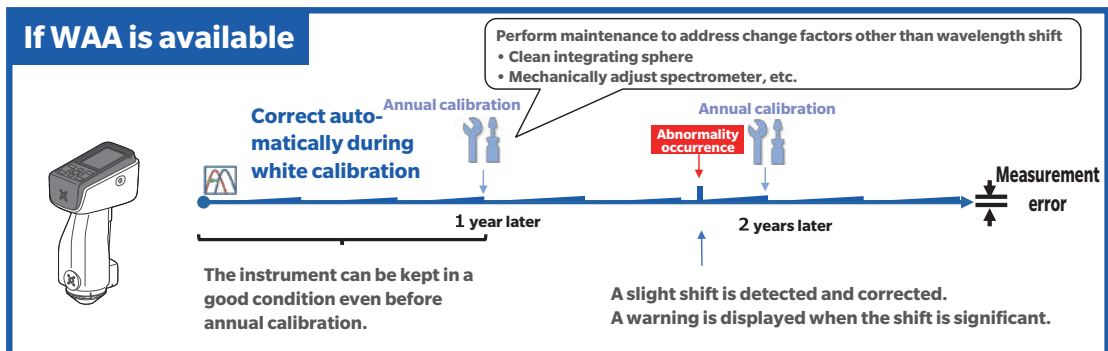
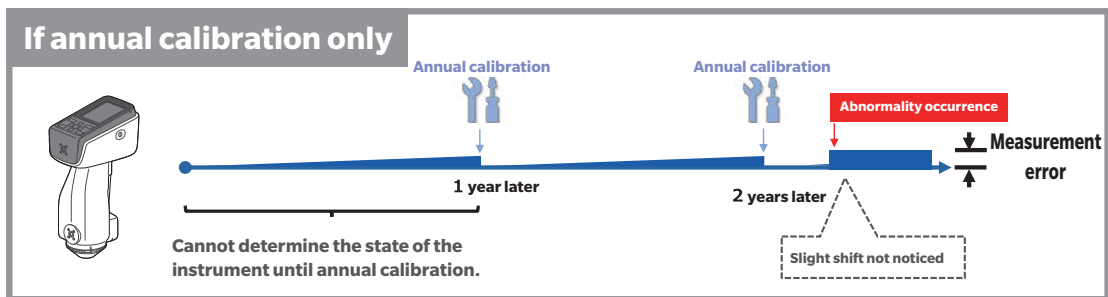
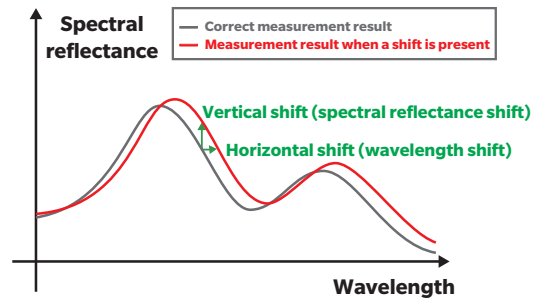

<The figure shows a conceptual diagram of the annual calibration/WAA.>

Specifications

Model	CM-17d	CM-16d
Illumination/viewing system	di:8°, de:8° (diffuse illumination: 8° viewing), SCI (specular component included) / SCE (specular component excluded) switchable	
Applicable standards for illumination/viewing system	Conforms to ISO 7724/1, CIE No. 15 (2004), ASTM E 1164 (SCI), DIN 5033 Teil 7, JIS Z 8722 Condition c standard	
Integrating sphere	Ø40 mm	
Detector	Dual 32-element silicon photodiode arrays	
Spectral separation device	Planar diffraction grating	
Wavelength range	400 nm to 700 nm	
Measurement wavelength pitch	10 nm	
Half bandwidth	Approx. 10 nm	
Reflectance range	0 to 175%; Resolution: 0.01%	
Light source	Pulsed xenon lamp (with UV cut filter)	
Measurement time	Approx. 0.7 s (Measurement mode: SCI or SCE, from pressing trigger button to measurement completion)	
Minimum measurement interval	Approx. 1.5 s (Measurement mode: SCI or SCE)	
Battery performance	Approx. 2,000 measurements (approx. 1,000 measurements when using Optional WLAN/Bluetooth module) when measurements are taken at 10-second intervals at 23°C with the dedicated lithium battery, without using camera viewfinder	
Measurement area/Illumination area	MAV: Ø8 mm/Ø11 mm SAV: Ø3 mm/Ø6 mm * Can be changed by replacing the target mask and switching the lens position	MAV: Ø8 mm/Ø11 mm
Repeatability	Standard deviation within ΔE^*ab 0.02 (When a white calibration plate is measured 30 times at 5-second intervals after white calibration under Konica Minolta standard conditions)	Standard deviation within ΔE^*ab 0.04 (When a white calibration plate is measured 30 times at 5-second intervals after white calibration under Konica Minolta standard conditions)
Inter-instrument agreement	Within ΔE^*ab 0.12 (Based on average for 12 BCRA Series II color tiles; MAV SCI; compared to values measured with a master body under Konica Minolta standard conditions)	Within ΔE^*ab 0.2 (Based on average for 12 BCRA Series II color tiles; MAV SCI; compared to values measured with a master body under Konica Minolta standard conditions)
Display	2.7-inch TFT color LCD with reversible portrait viewing mode	
Internal performance check*1	WAA (Wavelength Analysis & Adjustment) Technology	
Interface	USB 2.0; WLAN (IEEE 802.11 b/g/n)/Bluetooth (Ver. 4.1, SPP-compatible.) Optional WLAN/Bluetooth module required*2*3	
Camera viewfinder function	Using internal camera.: Images can be shown on display	—
Observer	2° Standard Observer, 10° Standard Observer	
Illuminant	A, C, D50, D65, F2, F6, F7, F8, F10, F11, F12, ID50, ID65, LED-B1, LED-B2, LED-B3, LED-B4, LED-B5, LED-BH1, LED-RGB1, LED-V1, LED-V2, User-configured illuminant**4 (Max. 3 types) (Simultaneous evaluation with two light sources possible)	
Display items	Colorimetric values/graph, color difference values/graph, spectral graph, pass/fail judgment, pseudocolor	
Color spaces	L*a*b*, L*C*h, Hunter Lab, Yxy, XYZ, and color difference in these spaces; Munsell (C)	
Indices	MI, WI (ASTM E313-73/ASTM E313-98); YI (ASTM E313-73, ASTM D1925); ISO brightness (ISO 2470); WI/Tint (CIE); Tristimulus Strength; Opacity; Grey scale (ISO 105-A05); gloss value; User index**5, Blackness (My) (ISO 18314-3/DIN 55979); Jetness (Mc) (ISO 18314-3); Undertone (dM) (ISO 18314-3)	
Color difference equations	ΔE^*ab (CIE 1976); ΔE^*94 (CIE 1994); ΔE_{00} (CIE DE2000); CMC (l:c); Hunter ΔE ; DIN 99o; FMC-2; ΔE^*94 (Special)**6	
Data memory	1,000 target data + 5,000 sample data	
Power	AC power supply	USB Type-C AC adapter (Power Delivery compatible, 15 W or more)
	Battery	Lithium-ion battery (removable)
	USB charging	USB bus power (with lithium-ion battery installed)
Charging time	Approx. 3.5 h (rapid charge) / Approx. 6 h (standard)	
Size	Approx. 79 (W) × 230 (H) × 128 (D) mm	
Weight	Approx. 700 g (Lithium-ion battery included)	Approx. 660 g (Lithium-ion battery included)
Operating temperature/humidity range	Temperature: 5 to 40°C; Relative humidity: 80% or less (at 35°C) with no condensation	
Storage temperature/humidity range	Temperature: 0 to 45°C; Relative humidity: 80% or less (at 35°C) with no condensation	

- *1 **The WAA function enables wavelength diagnosis and wavelength correction of the instrument. This function is available free of charge for the first year after purchase, and can be continued after the second year by having the instrument serviced and calibrated.**
 - *2 **Requires optional accessory WLAN/Bluetooth module (CM-A300).**
 - *3 **WLAN security supports WPA2-PSK (WPA2-Personal) and WPA-PSK (WPA-Personal) for the AdHoc method, and WPA3-PSK (WPA3-Personal), WPA2-PSK (WPA2-Personal) and WPA-PSK (WPA-Personal) for the Infrastructure method.**
 - *4 **Optional Color Data Software SpectraMagic NX2 Pro (Ver. 1.3 or later) is required for setting user-configured illuminants.**
 - *5 **Spectrophotometer Configuration Tool CM-CT1 Ver. 1.5 or later and a valid Color Data Software SpectraMagic NX2 license are required for setting user indices.**
 - *6 **When comparing two colors, please use ΔE^*94 (Special) if one of them is not specified as the standard.**
-
- **The specifications and appearance shown herein are subject to change without notice.**
 - **Bluetooth® is a registered trademark of Bluetooth SIG, Inc. and is used under license agreement.**

Dimensions

CM-17d/CM-16d

(Unit: mm)

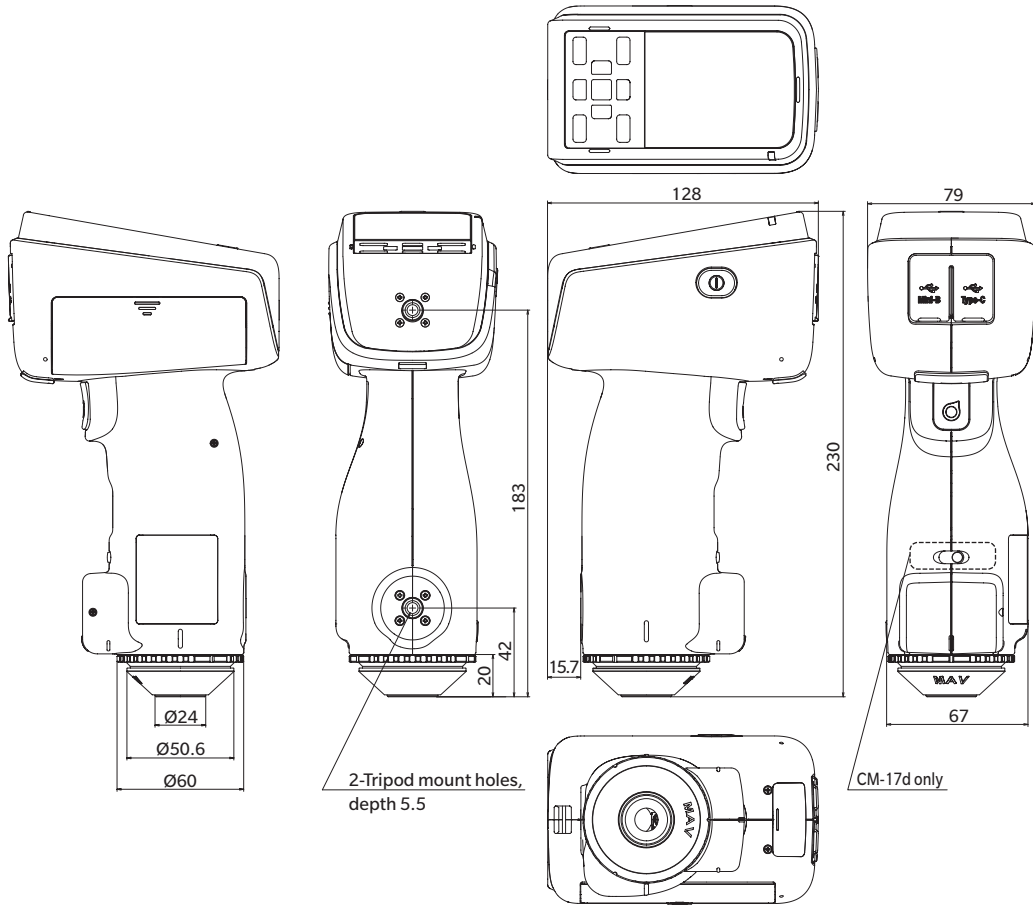

**User Equation and User Class
(For CM-17d, CM-16d)**

User Equation and User Class

- The user equation function allows users to register their own calculation formulas to the instrument based on the samples for L*, a*, b*, etc. obtained using the instrument, and then display the calculation results on the instrument.
- The user class function performs classifications (such as grade classification and rank classification) based on the obtained samples and calculation results.

Using the User Equation and User Class Functions with the Instrument

To use the user equation and user class functions with the instrument, use SpectraMagic NX2.

- User classes are defined based on user equations that have the same number. UC1 is defined based on UE1. If no user equation is defined for the selected UC number, the user class definition will not be used.

Displaying the User Equation and User Class Calculation Results on the Instrument

The user equation and user class calculation results can be displayed on the instrument by selecting UE1 to UE3 (user equation 1 to 3) and UC1 to UC3 (user class 1 to 3) on the instrument’s “Custom” display setting. (Refer to the display settings in the instrument’s instruction manual.)

Samples Usable for Calculations

Samples that can be used with the user equation function are as follows.

Numbers and decimal points as well as XYZ, Yxy, L*a*b*, L*C*h, Hunter Lab, and others indicated below can be used as calculation parameters.

* The samples to be used for calculations must be set to be displayed in the “Color space”, “Equation”, or “Custom” display settings of “Display cond.” on the instrument. (See “Display Settings”.)

* Samples not listed below cannot be used.

L*	a*	b*
ΔL*	Δa*	Δb*
C*	h	
ΔC*	ΔH*	
L (Hunter)	a (Hunter)	b (Hunter)
ΔL (Hunter)	Δa (Hunter)	Δb (Hunter)
X	Y	Z
ΔX	ΔY	ΔZ
x	y	
Δx	Δy	
ΔE*ab	CMC	ΔE*94
ΔE*94 (Special)	ΔE00	ΔE (Hunter)
ΔE99o	FMC2	MI
WI E313-73	WI CIE	Tint CIE
ΔWI E313-73	ΔWI CIE	ΔTint CIE
YI E313-73	ΔYI E313-73	YI D1925
ΔYI D1925	B (ISO)	ΔB (ISO)
GreyScale ISO-A105	8GU	Δ8GU
K/S St (ΔE*)	K/S St (MAX Abs)	K/S St (Apparent)
Staining ISO 105-A04	ΔL (FMC2)	ΔCr-g (FMC2)
ΔCy-b (FMC2)	Blackness (My)	ΔBlackness (ΔMy)
Jetness (Mc)	ΔJetness (ΔMc)	Undertone (dM)
ΔUndertone (ΔdM)		

The input format is as follows.

Operators and Functions Usable for Arithmetic Operations

The following operators and functions can be used. The input format is as follows.

Four arithmetic operators	Trigonometric functions (inverse trigonometric function)	Other functions
+, -, ×, ÷	sin, cos, tan, sin ⁻¹ , cos ⁻¹ , tan ⁻¹	X ² (square), √ (square root), abs (absolute value), log (ordinary logarithm), ln (natural logarithm), ex (exponent), y [*] (power)

User Equation

Input Example

To input $\Delta E^*ab: \Delta E^*ab = \sqrt{(\Delta L^*)^2 + (\Delta a^*)^2 + (\Delta b^*)^2}$,

use the following formula as the user equation.

(Ex.) SQRT(POW([DL])+POW([DA])+POW([DB]))

Format

The user equation defines "sample variables", "functions", and "values" in a string.

- The parameters that are usable for calculation are as follows.
- The user equation can only contain up to 200 single-byte characters together with the above calculation parameters.

Constants

- Numbers (0 to 9) and decimal points (.) for input

There is no limit to the number of digits to be entered, but the number of significant digits for arithmetic purposes is 5.

Colorimetric Value Variables

When Using CM-17d/CM-16d

* On the SCI screen, the SCI value, and on the SCE screen, the SCE value.

Variable	Description	Variable	Description	Variable	Description
[L]	L*	[A]	a*	[B]	b*
[DL]	ΔL^*	[DA]	Δa^*	[DB]	Δb^*
[C]	C*	[H]	h		
[DC]	ΔC^*	[DH]	ΔH^*		
[HL]	L (Hunter)	[HA]	a (Hunter)	[HB]	b (Hunter)
[DHL]	ΔL (Hunter)	[DHA]	Δa (Hunter)	[DHB]	Δb (Hunter)
[X]	X	[Y]	Y	[Z]	Z
[DX]	ΔX	[DY]	ΔY	[DZ]	ΔZ
[SX]	x	[SY]	y		
[DSX]	Δx	[DSY]	Δy		
[DE]	ΔE^*ab	[CMC]	CMC	[DE94]	ΔE^*94
[DE94S]	ΔE^*94 (Special)	[DE00]	$\Delta E00$	[DEH]	ΔE (Hunter)
[DE99o]	$\Delta E99o$	[FMC2]	FMC2	[MI]	MI
[WIE]	WI E313-73	[WIC]	WI CIE	[TINT]	Tint CIE
[DEWI]	ΔWI E313-73	[DWIC]	ΔWI CIE	[DTINT]	$\Delta Tint$ CIE
[YIE]	YI E313-73	[DYIE]	ΔYI E313-73	[YID]	YI D1925
[DYID]	ΔYI D1925	[BISO]	B (ISO)	[DBISO]	ΔB (ISO)
[GS]	GreyScale ISO-A105	[8GU]	8GU	[D8GU]	$\Delta 8GU$
[KSDE]	K/S St (ΔE^*)	[KSMA]	K/S St (MAX Abs)	[KSAP]	K/S St (Apparent)
[ST]	Staining ISO 105-A04	[DLFMC2]	ΔL (FMC2)	[DCRFMC2]	$\Delta Cr-g$ (FMC2)
[DCYFMC2]	$\Delta Cy-b$ (FMC2)				

When Using SCI Samples

* When the following variables are used, the SCI value is also displayed on the SCE screen.

* SCI must be included in the instrument's specular component settings.

Variable	Description	Variable	Description	Variable	Description
[LI]	L*	[AI]	a*	[BI]	b*
[DLI]	ΔL^*	[DAI]	Δa^*	[DBI]	Δb^*
[CI]	C*	[HI]	h		
[DCI]	ΔC^*	[DHI]	ΔH^*		
[HLI]	L (Hunter)	[HAI]	a (Hunter)	[HBI]	b (Hunter)
[DHLI]	ΔL (Hunter)	[DHAI]	Δa (Hunter)	[DHBI]	Δb (Hunter)
[XI]	X	[YI]	Y	[ZI]	Z
[DXI]	ΔX	[DYI]	ΔY	[DZI]	ΔZ
[SXI]	x	[SYI]	y		
[DSXI]	Δx	[DSYI]	Δy		
[DEI]	ΔE^*ab	[CMCI]	CMC	[DE94I]	ΔE^*94
[DE94SI]	ΔE^*94 (Special)	[DE00I]	$\Delta E00$	[DEHI]	ΔE (Hunter)
[DE99oI]	$\Delta E99o$	[FMC2I]	FMC2	[MI]	MI
[WIEI]	WI E313-73	[WICI]	WI CIE	[TINTI]	Tint CIE
[DEWII]	ΔWI E313-73	[DWICI]	ΔWI CIE	[DTINTI]	$\Delta Tint$ CIE
[YIEI]	YI E313-73	[DYIEI]	ΔYI E313-73	[YIDI]	YI D1925
[DYIDI]	ΔYI D1925	[BISOI]	B (ISO)	[DBISOI]	ΔB (ISO)
[GSI]	GreyScale ISO-A105	[8GUI]	8GU	[D8GUI]	$\Delta 8GU$
[KSDEI]	K/S St (ΔE^*)	[KSMAI]	K/S St (MAX Abs)	[KSAPI]	K/S St (Apparent)
[STI]	Staining ISO 105-A04	[DLFMC2I]	ΔL (FMC2)	[DCRFMC2I]	$\Delta Cr-g$ (FMC2)
[DCYFMC2I]	$\Delta Cy-b$ (FMC2)				

When Using SCE Samples

* When the following variables are used, the SCE value is also displayed on the SCI screen.

* SCE must be included in the instrument's specular component settings.

Variable	Description	Variable	Description	Variable	Description
[LE]	L*	[AE]	a*	[BE]	b*
[DLE]	ΔL^*	[DAE]	Δa^*	[DBE]	Δb^*
[CE]	C*	[HE]	h		
[DCE]	ΔC^*	[DHE]	ΔH^*		
[HLE]	L (Hunter)	[HAE]	a (Hunter)	[HBE]	b (Hunter)
[DHLE]	ΔL (Hunter)	[DHAE]	Δa (Hunter)	[DHBE]	Δb (Hunter)
[XE]	X	[YE]	Y	[ZE]	Z
[DXE]	ΔX	[DYE]	ΔY	[DZE]	ΔZ
[SXE]	x	[SYE]	y		
[DSXE]	Δx	[DSYE]	Δy		
[DEE]	ΔE^*ab	[CMCE]	CMC	[DE94E]	ΔE^*94
[DE94SE]	ΔE^*94 (Special)	[DE00E]	$\Delta E00$	[DEHE]	ΔE (Hunter)
[DE99oE]	$\Delta E99o$	[FMC2E]	FMC2	[MIE]	MI
[WIEE]	WI E313-73	[WICE]	WI CIE	[TINTE]	Tint CIE
[DEWIE]	ΔWI E313-73	[DWICE]	ΔWI CIE	[DTINTE]	$\Delta Tint$ CIE
[YIEE]	YI E313-73	[DYIEE]	ΔYI E313-73	[YIDE]	YI D1925
[DYIDE]	ΔYI D1925	[BISOE]	B (ISO)	[DBISOE]	ΔB (ISO)
[GSE]	GreyScale ISO-A105	[8GUE]	8GU	[D8GUE]	$\Delta 8GU$
[KSDDEE]	K/S St (ΔE^*)	[KSMABE]	K/S St (MAX Abs)	[KSAPE]	K/S St (Apparent)
[STE]	Staining ISO 105-A04	[DLFMC2E]	ΔL (FMC2)	[DCRFMC2E]	$\Delta Cr-g$ (FMC2)
[DCYFMC2E]	$\Delta Cy-b$ (FMC2)	[MYE]	Blackness (My)	[DMYE]	$\Delta Blackness$ (ΔMy)
[MCE]	Jetness (Mc)	[DMCE]	$\Delta Jetness$ (ΔMc)	[DME]	Undertone (dM)
[DDME]	$\Delta Undertone$ (ΔdM)				

Ex.: Results displayed when only SCI or only SCE is used on the SCI and SCE screens

	SCI	SCE
[L]	100	50
[L]+[L].[LL]	250 (= 100+100+50)	200 (= 50+100+50)

The operators and functions that are usable for calculation are as follows.

Function	Example	Description
+	A+B	A + B
-	A-B	A - B
*	A*B	A × B
/	A/B	A ÷ B
POW	POW(A)	A ²
SQRT	SQRT(A)	Square root of A
ABS	ABS(A)	Absolute value of A
SIN	SIN(A)	Sine of A (degree)
COS	COS(A)	Cosine of A (degree)
TAN	TAN(A)	Tangent of A (degree)
ASIN	ASIN(A)	Arc sine (degree)
ACOS	ACOS(A)	Arc cosine (degree)
ATAN	ATAN(A)	Arc tangent (degree)
LOG	LOG(A)	Common logarithm
LN	LN(A)	Natural logarithm
EXP	EXP(A)	Exponential function
POW2	POW2(A,B)	Power function (A ^B)

User Class

The user class classifies samples according to the result of the user equation of the same number. For example, UC1 classifies samples based on the result for UE1.

Example of User Class Input

Classifying samples into 5 classes (A, B, C, D, and E) based on the following conditions

User equation result	Class
4 or more	A
3 or more	B
2 or more	C
1 or more	D
Less than 1	E

Classes are defined as follows.

```
CLASS(4, "A", 4, "B", 3, "C", 2, "D", 1, "E")
```

Input Format

```
CLASS(n, "str1", d1, "str2", d2, "str3", d3, ...)
```

n: Indicates the number of threshold values for classification. The number will be ("number of classes" - 1), and no more than 50 can be specified.

"str1", d1: When the result of user class discrimination is d1 or higher, "str1" is displayed in the result column of the instrument. str1 must be no more than 6 characters. d1 can be set to a value of up to 20 characters, but only up to 5 digits are significant for arithmetic purposes. Enter from the left in order of the highest numerical threshold value, and be sure to set the class to be displayed when the sample is not classified at or above any threshold value. Also, make sure that the total number of characters entered (including CLASS()) is no more than 200 single-byte characters. If a user class is not used, leave the user class unentered. Use "." for decimal points. Use "," to delimit parameters.

List of Usable Characters

The following characters can be entered. (sp) indicates a space code. Blank cells indicate areas that cannot be used.

	00	10	20	30	40	50	60	70
0			(sp)	0	@	P	`	p
1			!	1	A	Q	a	q
2			"	2	B	R	b	r
3			#	3	C	S	c	s
4			\$	4	D	T	d	t
5			%	5	E	U	e	u
6			&	6	F	V	f	v
7			'	7	G	W	g	w
8			(8	H	X	h	x
9)	9	I	Y	i	y
A			*	:	J	Z	j	z
B			+	;	K	[k	{
C			,	<	L	\	l	
D			-	=	M]	m	}
E			.	>	N	^	n	
F			/	?	O	_	o	

< CAUTION >

- **KONICA MINOLTA WILL NOT BE LIABLE FOR ANY DAMAGES RESULTING FROM THE MISUSE, MISHANDLING, UNAUTHORIZED MODIFICATION, ETC. OF THIS PRODUCT, OR FOR ANY INDIRECT OR INCIDENTAL DAMAGES (INCLUDING BUT NOT LIMITED TO LOSS OF BUSINESS PROFITS, INTERRUPTION OF BUSINESS, ETC.) DUE TO THE USE OF OR INABILITY TO USE THIS PRODUCT.**



KONICA MINOLTA