

Spectrophotometer CM-2500c

E Instruction Manual



KONICA MINOLTA

Safety Symbols

The following symbols are used in this manual to prevent accidents which may occur as result of incorrect use of the instrument.



Denotes a sentence regarding a safety warning or note.
Read the sentence carefully to ensure safe and correct use.



Denotes a prohibited operation.
The operation must never be performed.



Denotes an instruction.
The instruction must be strictly adhered to.



Denotes a prohibited operation.
Never disassemble the instrument.











Denotes an instruction.
Disconnect the AC power cord from the AC outlet.





Notes on this Manual

- Copying or reproduction of all or any part of the contents of this manual without KONICA MINOLTA permission is strictly prohibited.
- The contents of this manual are subject to change without prior notice.
- Every effort has been made in the preparation of this manual to ensure the accuracy of its contents. However, should you have any questions or find any errors, please contact a KONICA MINOLTA-authorized service facility.
- KONICA MINOLTA will not accept any responsibility for consequences arising from the use of the instrument.

Safety Precautions

To ensure correct use of this instrument, read the following points carefully and adhere to them. After you have read this manual, keep it in a safe place where it can be referred to anytime a question arises.

 WARNING (Failure to adhere to the following points may result in death or serious injury.)			
	<p>Do not use the instrument in places where flammable or combustible gases (gasoline etc.) are present. Doing so may cause a fire.</p>		<p>Do not disassemble or modify the instrument or the AC adapter. Doing so may cause a fire or electric shock.</p>
	<p>Always use the AC adapter supplied as a standard accessory or the optional AC adapter, and connect it to an AC outlet of the rated voltage and frequency. If the AC adapters other than those specified by KONICA MINOLTA, this may result in damage to the unit, fire or electric shock</p>		<p>The instrument should not be operated if it is damaged or AC adapter is damaged, or if smoke or odd smells occur. Doing so may result in a fire. In such situations, turn the power OFF immediately, disconnect the AC adapter from the AC outlet (or remove the batteries if they are used) and contact the nearest KONICA MINOLTA-authorized service facility.</p>
	<p>If the instrument will not be used for a long time, disconnect the AC adapter from the AC outlet. Accumulated dirt or water on the prongs of the AC adapter's plug may cause a fire and should be removed.</p>		<p>Do not insert or disconnect the AC adapter with wet hands. Doing so may cause electric shock.</p>
	<p>Take special care not to allow liquid or metal objects to enter the instrument. Doing so may cause a fire or electric shock. Should liquid or metal objects enter the instrument, turn the power OFF immediately, disconnect the AC adapter from the AC outlet (or remove the batteries if they are used), and contact the nearest KONICA MINOLTA-authorized service facility.</p>		<p>Do not dispose of batteries in fire, short their terminals, apply heat to them, or disassemble them. Also, do not recharge them (if they are not chargeable). Doing so may cause explosion or heat generation, resulting in fire or injury.</p>

 CAUTION (Falling to adhere to the following points may result in injury or damage to the instrument or other property.)			
	<p>Do not perform measurement which the measurement aperture directed towards your face. Doing so may damage them.</p>		<p>Do not place the instrument on an unstable or sloping surface. Doing so may result in its dropping or overturning, causing injury. Take care not to drop the instrument when carrying it.</p>
	<p>Do not use batteries other than those specified by KONICA MINOLTA. When installing batteries in the instrument, make sure that they are correctly oriented according to the (+) and (-) marks. Failure to adhere to these instructions may cause batteries to explode or leakage of electrolyte, resulting in fire, injury or air pollution.</p>		<p>When using the AC adapter, make sure that the AC outlet is located near the instrument and that the AC adapter can be connected to and disconnected from the AC outlet easily.</p>

Notes on Use

<Operating Environment>

- This instrument and the AC adapter supplied as a standard accessory have been designed exclusively for indoor use.
- Do not leave the CM-2500c in direct sunlight or near sources of heat, such as stoves etc. The internal temperature of the instrument may become much higher than the ambient temperature in such cases.
- Do not use the CM-2500c in areas where dust, cigarette smoke or chemical gases are present. Doing so may cause deterioration in performance or breakdown.
- Do not use the CM-2500c near equipment which produces a strong magnetic field (such as speakers etc.)
- The CM-2500c belongs to installation category II products (equipment which is powered by an AC adapter connected to a commercially available power).
- The CM-2500c belongs to pollution level 2 products (equipment which may cause temporary electrical hazards due to contamination or condensation or products which are used in such an environment).
- Do not use the CM-2500c at altitudes of higher than 2000m.
- Use this instrument at ambient temperature between 5 and 40° C and relative humidity 80% or less (at 35°C) with no condensation^(*1). Operating this instrument outside specified temperature and humidity range may unsatisfy its original performance.

*1 Operating temperature/humidity range of products for North America: between 5 and 40°C and relative humidity 80% or less (at 31°C) with no condensation

<Measurement>

- When using the instrument upside-down, make sure no dirt or dust enters the measuring aperture.
- When using the instrument for long periods of time, the measurement value may change depending on changes in the environment. Therefore, in order to achieve accurate measurements, we recommend that white calibration be done regularly using the White Calibration Plate.

<White Calibration Plate>

- The calibration data for the White Calibration Plate was measured at 23°C. To achieve the highest accuracy when measuring absolute values (colorimetric values), calibration and measurement should be performed at 23°C.
- Do not allow the White Calibration Plate to get scratched or stained.
- If you are not going to use the White Calibration Plate, attach the cap to the White Calibration Plate to prevent entry of ambient light.

<Power Source>

- Make sure that the power switch is set to OFF (“O”) when the CM-2500c is not in use.
- Always use the AC adaptor (AC-A305) supplied as a standard accessory and connect it to an AC outlet of the rated voltage and frequency. Use the AC power supply voltage of the rated supply voltage (within $\pm 10\%$).

<System>

- Do not subject the CM-2500c to strong impact or vibration. Doing so may cause deterioration in performance or breakdown.
- Since the specimen measuring aperture uses extremely precise optical components, great care should be taken to prevent them from getting dirty or being exposed to impact. If you do not use the CM-2500c, put it on the White Calibration Plate (CM-A153).
- The CM-2500c may cause interference if used near a television, radio, etc.
- Since the CM-2500c uses a microcomputer, the LCD may go blank if it is exposed to strong static electricity. In this case, turn the power OFF, then turn it ON again. If black smudges appear on the LCD, wait until they disappear naturally.
- When turning the power OFF and then ON again, wait several seconds after turning the power OFF.

<Backup Battery>

- Measured data and various settings are stored in the memory backed up by batteries. The backup batteries are automatically charged during operation of this instrument, and can retain the contents of the memory for 4.5 months if they have been fully charged. At the time of purchase, the backup battery may not be fully charged. To charge the backup battery, set the power switch to ON. Charging of the backup battery is performed continuously while the instrument is switched on, even while the instrument is being used. Full charging is completed in 25 hours, and there is no danger of overcharging.
- It is recommended to keep a backup of your important data in another recording medium using optional Color Data Software (sold separately).

Note

- *The backup batteries' model number is VL2020 (3V).*
- *Do not try to replace the backup batteries by yourself. Contact a KONICA MINOLTA-authorized service facility.*

Notes on Storage

- The CM-2500c should be stored at temperatures between 0°C and 45°C, and at a relative humidity of 80% or less (35°C), without condensation. Do not store the instrument in areas subject to high temperatures, high humidity, sudden changes in temperature, or where freezing or condensation may occur, because these circumstances may cause breakdown. It is more reliable to store the CM-2500c with a drying agent at a temperature around 20°C.
- Do not leave the CM-2500c inside a car such as in the cab or trunk. Otherwise, the temperature and/or humidity may go leave the allowable range for storage during midsummer or midwinter, resulting in breakdown.
- Keep the packing materials used for shipment and use it to transport the CM-2500c. This protects the instrument from sudden changes in temperature, vibration, and shock.
- Do not store the CM-2500c in areas where dust, cigarette smoke or chemical gases are present. Doing so may cause deterioration in performance or breakdown.
- Entry of dust into the measuring aperture will hinder accurate measurement. Block the measuring port to prevent entry of the dust.
- The White Calibration Plate may become discolored if left exposed to light. Therefore, make sure that the lid is closed to prevent entry of ambient light when it is not in use.
- Be sure to keep all packing materials (cardboard box, cushioning material, plastic bags, etc.). They can be used to protect the instrument during transportation to service facility for maintenance (re-calibration etc.).
- If you are not going to use the CM-2500c for more than two weeks, the batteries must be removed. If the batteries are left in the instrument, leakage may occur resulting in damage to the instrument.

Notes on Cleaning

- If the CM-2500c becomes dirty, wipe it with a soft, clean dry cloth. Never use solvents such as thinner and benzene.
- If the White Calibration Plate becomes dirty, wipe it gently with a soft, clean dry cloth. If dirt is difficult to remove, contact the nearest service facility listed on the attached sheet.
- If the inner surface of the measuring aperture gets dirty, contact an authorized KONICA MINOLTA service facility.
- Should the CM-2500c break down, do not try to disassemble and repair it by yourself. Contact a KONICA MINOLTA-authorized service facility.

Contents

Safety Precautions	E-1
Notes on Use	E-2
Notes on Storage	E-3
Notes on Cleaning	E-4
Conventions	E-7

Chapter 1 Before Using the Instrument

Accessories	E-10
Standard Accessories	E-10
Optional Accessories	E-11
Names and Functions of Parts	E-12
Preparation	E-14
Cleaning Each Part	E-14
Inserting the Batteries	E-15
Connecting the AC Adapter	E-16
Turning Power ON	E-17
Turning Power OFF	E-17
System Configuration	E-18
Items You Must Know	E-19
Language Mode	E-19
Target Modes	E-19
Screen Display	E-19
Battery Alarm	E-20
Data Saving	E-20

Chapter 2 Preparation for Measurement

Flow of Measurement	E-22
Turning Power On for the First Time	E-23
Setting the Language Mode	E-23
Selecting the Target Mode	E-24
Initial Setting	E-25
Setting the Date and Time	E-26
Setting the Display Direction	E-27
Setting the LCD Contrast	E-28
Selecting a Measurement Condition	E-29
Setting a Measurement Condition	E-30
Selecting Illuminant 1	E-31
Selecting Illuminant 2	E-31
Selecting the Observer	E-31
Selecting the Display Mode	E-32
Selecting a Color Space	E-33
Setting the Number of Measurements for Manual Averaging	E-34
Setting the Standard Deviation for Manual Averaging	E-34
Setting the Number of Measurements for Auto Averaging	E-35
Setting the Delay Time	E-35
Zero Calibration	E-38
White Calibration	E-40

Setting a Color Difference Target Data	E-42
Selecting a Color Difference Target Data	E-45
Deleting a Color Difference Target Data	E-46
Setting Color Difference Tolerances	E-47
Box Tolerance	E-47
Elliptical Tolerance	E-50

Chapter 3 Measurement

Measurement	E-56
Displaying the Measurement Results	E-58
Measured Data	E-58
Pass/Fail Judgment	E-59
Color Difference Graph	E-60
Spectral Reflectance Graph	E-61
Assessments	E-62
Switching the Display Contents of the Measurement Results	E-63
Deleting Measured Data	E-64
Abbreviations on LCD Display	E-66
Measurement Results for “linked to each data.”	E-67

Chapter 4 Other Functions

Measuring the Average	E-70
Manual Averaging	E-70
Auto Averaging	E-72
Pass/Fail Judgment for Color Difference	E-73
Pass/Fail Judgment Based on Box Tolerances	E-73
Pass/Fail Judgment Based on Elliptical Tolerances	E-75
Connecting to an External Device	E-77
Connecting a Personal Computer	E-77
Outputting to a Printer	E-80

Chapter 5 Troubleshooting

Error Messages	E-88
Troubleshooting	E-90

Chapter 6 Appendix

Principles of Measurement	E-94
Illuminating/Viewing System	E-94
Target Mode	E-95
Relation Between Measured Data and Target Color	E-95
Deleting a Color Difference Target Data	E-95
Notes on Changing the Target Mode	E-95
Specifications	E-96
Dimensions	E-98
Menu Structure	E-100
Reading the menu structure diagram	E-100
Menu Structure diagram	E-101

Conventions

This manual describes how to setup the CM-2500c which the firmware version is 5.01 or higher and use it to take measurements.

• Organization

The CM-2500c (Ver. 5.00 or higher) supports two types of the target mode, “linked to each data.” and “defined in COND.”; the procedure and details for these types varies slightly.

This manual describes the procedures for the default target mode, which is “linked to each data.”. It only includes information for the “defined in COND.” mode where it differs from the default.

• Page layout

Symbols used in this manual are explained below.

*Note that the page shown in the illustration is for explanatory purposes only, and is not an actual page from this manual.

[Memo]
Gives useful Information and additional explanations.

[Note]
Gives the points that you should know to perform operations correctly. Make sure that you read the notes.

Screen
Shows the contents of the screen in effect when the given operation is carried out.

Setting an Environmental Condition

Up to six sets of conditions (COND 1 to COND 6) can be set. Since the instrument will perform measurement according to the selected condition, conditions must be set prior to start of measurement. The following nine condition items can be set:

[Memo]
• A setting can be made for the currently highlighted item. To confirm the setting, press . The next item will be highlighted automatically.

[Note]
• The items (1) to (9) must be set in this order. If incorrect settings have been made, you must start once again from item (1).

[Setting Procedure]
<FILE> screen

- Turn to select “SEL”, then press .

COND1 <FILE> 1/2

ILLUMINANT1 D65

ILLUMINANT2 10°

OBSERVER 2°

DISPLAY DIFF&ABS

SEL ▶/2/ BREAK PREV

• “SEL” can be selected in page 1/2 only.

- Turn to select the desired setting, then press .

COND1 <FILE> 1/2

ILLUMINANT1 10°

ILLUMINANT2 2°

OBSERVER 2°

DISPLAY

↑ : <MEAS.> BUTTON

<Settings>

- 10° : 10° observer (CIE1964)
- 2° : 2° observer (CIE1931)
- Keeping held down to left or right will cause the value to change continuously.

- Direct the specimen measuring port to the specimen.

• If necessary, slide the viewfinder lever to check the position of the specimen.

60

Start screen
Shows the screen from which operation must be started.

Settings
Gives the range and explanation of the values to be set in this screen.

TIP (screen)
Gives explanation about the screen and operations that can be carried out from this screen.

Procedure
Shows the operating procedure.

..... Indicates the <MEAS.> button.

..... Indicates request to turn the navigation wheel to the right or left.

..... Indicates request to press the navigation wheel.

Screen note
Gives the points to note on the operations to be performed from this screen.

For the version of the instrument firmware

The version of the instrument firmware can be confirmed on the screen which is displayed first after switching power on.



Chapter 1

Before Using the Instrument

Accessories

Standard and optional accessories are available with the instrument.

Standard Accessories

Make sure that all the following items are present.

White Calibration Plate CM-A153

Used to perform white calibration.

A data disk containing white calibration data is supplied with this accessory.

Memo

- This accessory can be used as a table on which to store the CM-2500c.

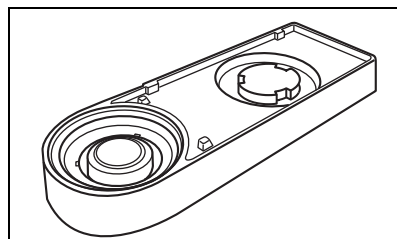

AC Adapter AC-A305

Used to supply power from an AC outlet to the instrument.

Input: Voltage: 100 to 240 V AC (50/60 Hz)

Output: Voltage: 5 V DC; Current: 2.0 A (Max.)

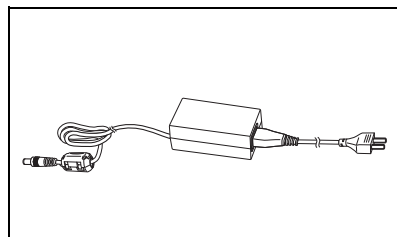

USB-Serial Converter Cable IF-A24

Used to connect the instrument to the USB interface of a personal computer (PC).

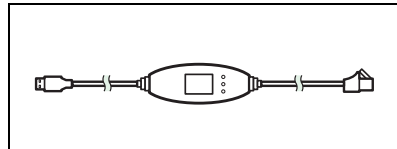

AA-size battery (×4)

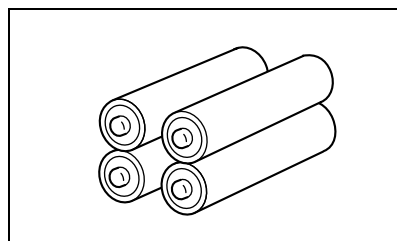

Optional Accessories

Zero Calibration Box CM-A32

Used to perform zero calibration.

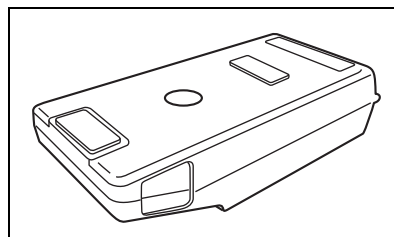

Hard Case CM-A148

Can be used for storing the CM-2500c, the instruction manual and standard accessories, such as the White Calibration Plate and AC adapter.

Note

The Hard Case is designed purely for storing the above items and must not be used for transportation purposes.

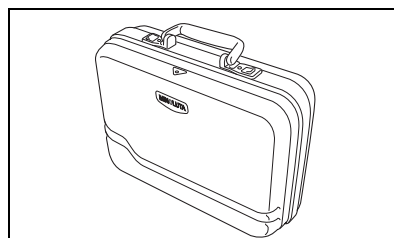

Dust Cover Set CM-A149

Used when measuring powder or wet surfaces.

It can also be used when woven fabric needs to be laid flat and measured.

Memo

The CM-A152 Dust Cover (polyolefin) can be used as the replacement.

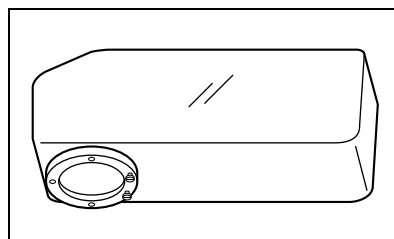

Color Data Software SpectraMagic NX (CM-S100w)

This software supports the two types of the target-mode, “linked to each data.” and “defined in COND.”, provided by this instrument. It allows you to operate the instrument from your PC, and to process data and manage files.

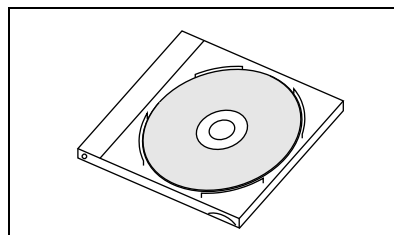

RS-232C Cable IF-A16

(for IBM PC/AT, 9-pin, 2m)

Used to connect the instrument to the RS-232C interface of a personal computer (PC).

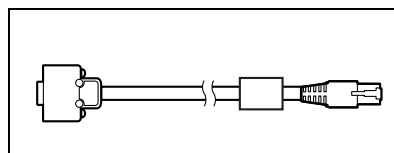

Printer Cable CR-A75

Used to transfer data to a printer. Connect a printer to the external output terminal on the instrument with this cable. The D-sub connector (9-pin) of the cable must be connected to the printer.

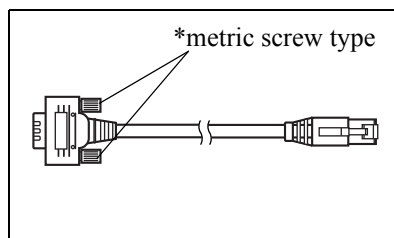

Names and Functions of Parts

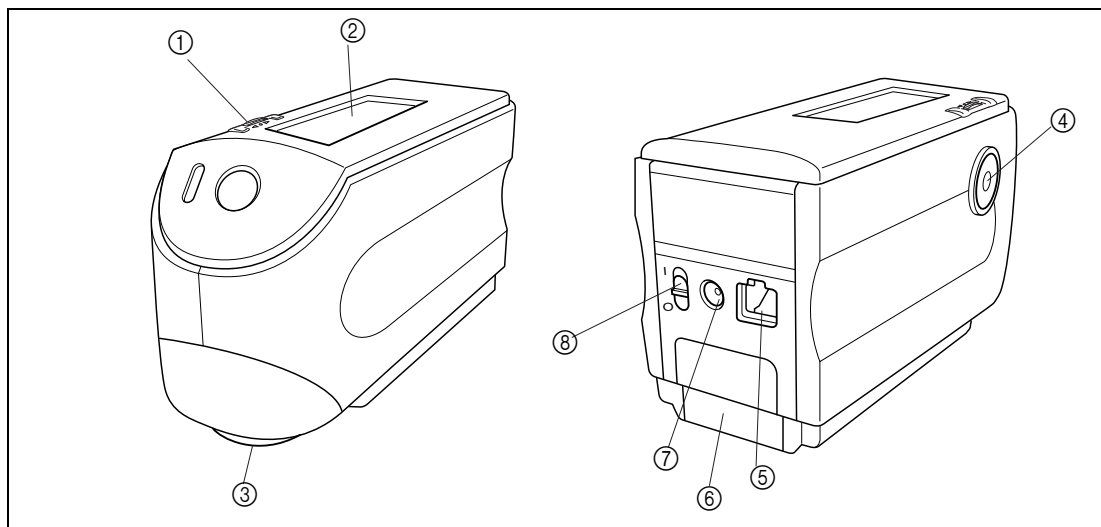

① Navigation wheel

Use this navigation wheel to select an item or set the selected item.

To select an item, turn it to the right or left until the desired item is shown. To set the selected item, press it.

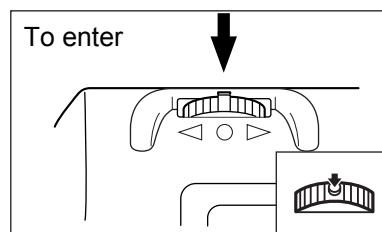
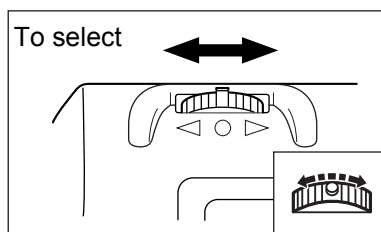

Memo

When selecting an item or setting a value, holding down the jog dial will switch the item or value from one to another continuously.

② LCD display

Displays the setting items and measured data.

③ Specimen measuring port

A port provided to measure the specimen.

④ Measuring button (MEAS. button)

Press this button to perform calibration or measurement.

Memo

When setting measurement conditions or tolerances, this button can be used as UNDO button to return to the previous item.

⑤ External output terminal

To transfer data to an external device, connect the included USB-Serial Converter Cable IF-A24 (or optional RS-232C Cable IF-A16 or Printer Cable CR-A75) to this terminal.

⑥ Battery cover

A cover for the battery chamber. Four AA-size batteries must be set in the battery chamber in the correct polarity direction.

⑦ AC adapter terminal

When using the AC adapter (AC-A305), connect the adapter's plug to this terminal.

⑧ POWER switch

Used to turn ON/OFF power. Setting this switch to “○” turns the power OFF, and setting it to “|” turns the power ON.

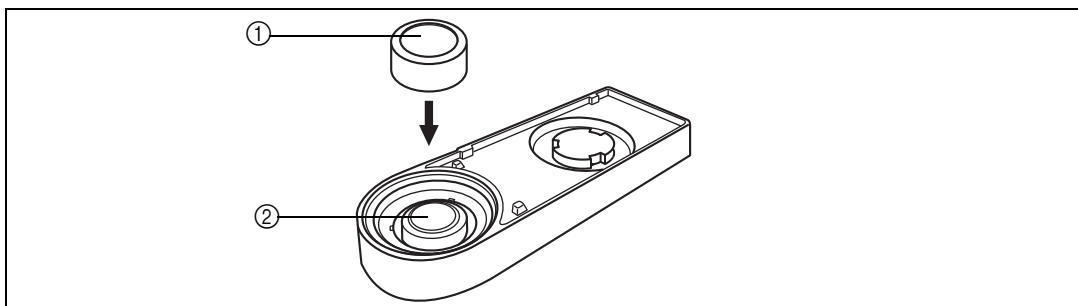
White Calibration Plate CM-A153**① Cap**

A cap provided to protect the White Calibration Plate.

Note

If you are not going to use the White Calibration Plate, attach the cap to the White Calibration Plate to prevent exposure to ambient light and protect it from scratches and dust.

② White Calibration Plate

Used to perform white calibration of the CM-2500c.

If you are not going to use it, attach the cap to prevent exposure to ambient light and protect it from scratches and dust.

Preparation

Cleaning Each Part

This section explains how to clean the measuring aperture and the White Calibration Plate.

White Calibration Plate

Gently wipe off dirt with a soft dry cloth. If dirt is difficult to remove, dampen a cloth with commercially available lens cleaning liquid and wipe. Then remove the liquid with a cloth dampened with water, and leave it to dry.

Note

Take care not to scratch the White Calibration Plate.

Inside the Measuring Aperture

1. Use a blower to remove dirt and dust from the measuring aperture.

Note

If the surface is so dirty that dirt cannot be removed with a blower, contact the nearest KONICA MINOLTA-authorized service facility.

2. Using a soft, dry cloth, wipe dirt gently off the condenser lens located inside the measuring aperture. (Refer to the figure on page E-94.) If dirt is difficult to remove, apply a cloth dampened with a commercially available lens cleaning liquid. Then, remove the liquid with a cloth dampened with water and leave it to dry.

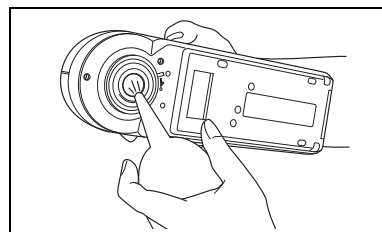

Note

Take care not to scratch the condenser lens.

Inserting the Batteries

To supply power to the instrument, the AC adapter (AC-A305) or four AA-size batteries (Alkaline or Ni-MH battery is recommended for better service life) must be used. Use either the AC adapter or batteries, according to which suits your application.

Note

- *If you are not going to use the instrument for more than two weeks, make sure that the batteries are removed. If the batteries are left in the instrument for long periods of time, battery electrolyte may leak and damage the instrument.*
- *Do not use batteries of different types or mix new batteries with old ones. Doing so may result in battery explosion or reduction of battery life.*
- *Do not touch or short-circuit the terminals inside the battery chamber. Doing so may result in breakdown of the instrument.*

[Operating Procedure]

- 1 Make sure that power is OFF (i.e. the POWER switch is set to “○”).

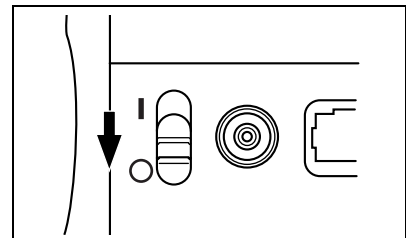

- 2 Slide the battery cover on the rear of the instrument to open it.

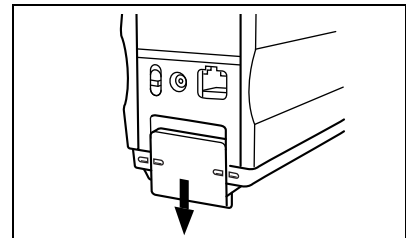

- 3 Place four AA-size batteries in the battery chamber. Make sure that the batteries are placed in the correct direction.

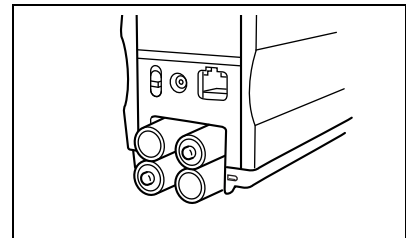

- 4 Align the marker on the battery cover with that on the instrument, and slide the battery cover to close it.

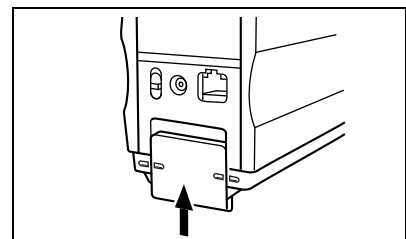

Connecting the AC Adapter

[Memo]

Use of the AC adapter (AC-A305) rather than batteries is recommended, since more power will be required when the external output terminal is used to output data to an external device or print it.

[Note]

- *To supply AC power to the instrument, always use the AC adapter (AC-A305) supplied with the instrument. (Rated: 5 V DC; 2.0 A)*
- *Before connecting or removing the AC adapter, make sure that power is turned OFF.*

[Operating Procedure]

- 1** Make sure that power is OFF (i.e. the power switch is set to “○”).

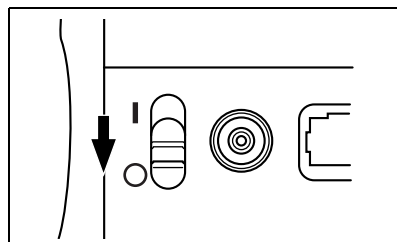

- 2** Connect the AC adapter's connector plug to the AC adapter terminal on the rear of the instrument.

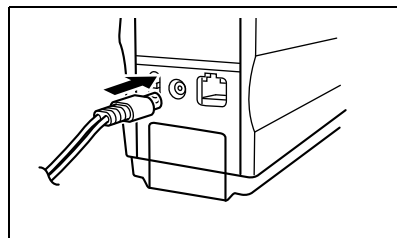

- 3** Insert the AC adapter's power plug to an AC outlet (100-240 V AC, 50/60 Hz).

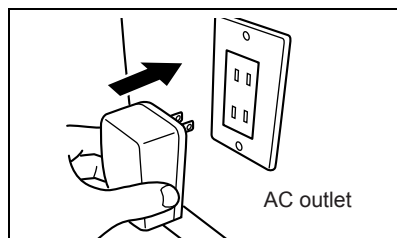

Turning Power ON

Note

When turning the power ON for the first time, the display language mode must be set.
For details, refer to page E-23.

[Operating Procedure]

- 1 Set the POWER switch to “|”.
The power will be turned ON.

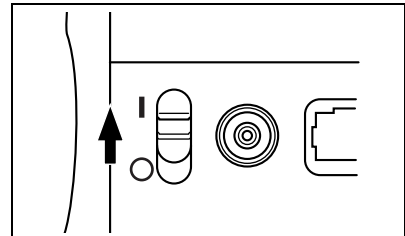

Turning Power OFF

[Operating Procedure]

- 1 Set the POWER switch to “○”.
The power will be turned OFF.

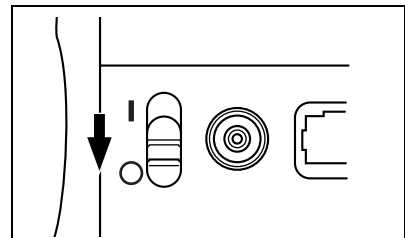

Auto Power Save Function

Power save mode will be activated if the MEAS. button and navigation wheel are not operated for more than three minutes. During power save mode, the flash circuit will not be charged. To cancel power save mode, press the MEAS. button to start measurement.

Note

- If the MEAS. button is pressed to cancel power save mode, start of measurement will be delayed by a few seconds, so keep the instrument still until the lamp flashes and measurement is taken.
- The auto power save function is not available in remote mode (see page E-78).

System Configuration

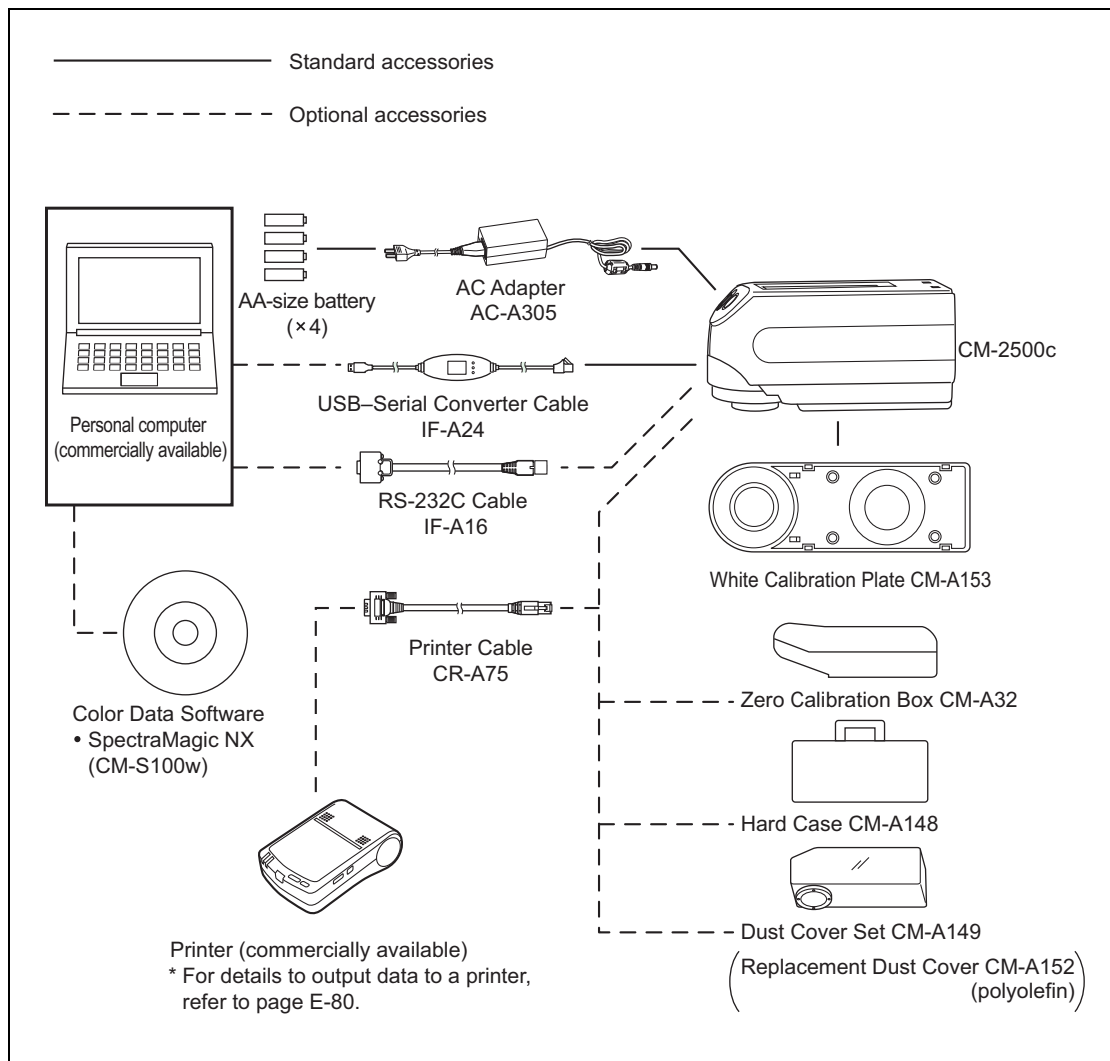

Items You Must Know

Language Mode

Contents on the LCD screen can be displayed in English, Japanese, German, French, Spanish or Italian. In this manual, explanation of operating methods and display is given for English mode.

Target Modes

- The CM-2500c supports two Target Modes, “defined in COND.” mode and “linked to each data.” mode, to analyze both measurement data and color difference. As with Language Mode, you can select the desired mode when you turn the power ON.
- The default setting is “linked to each data.” mode. To switch to “defined in COND.” mode or switch between the target modes, you need to follow the procedure to select target mode.
- Depending on the target mode selected, the display and the procedure for some operation for the instrument are different.

Below are some examples of these differences. (For details, see Target Mode in the Appendix.)

- In “linked to each data.” mode, the next color difference data number is displayed next to the currently selected color difference data number in the initial settings screen. When “defined in COND.” mode is selected, it is not displayed.
- In “linked with each data” mode, to display the color difference for measurement data, you can only select the color difference for the currently selected measurement data. When “defined in COND.” mode is selected, you can freely select the color difference data number after making measurements. You can also display the results of the selection.
- Data storage capacity for the “linked to each data.” mode is 1700 pieces, and that for the “defined in COND.” mode is 700 pieces.

Note

Once the target mode is changed, previous data will be cleared. It is recommended that you save previous data into other storage media in advance by using the Color Data Software that is optionally available.

Screen Display

The basic screen structure is shown below.

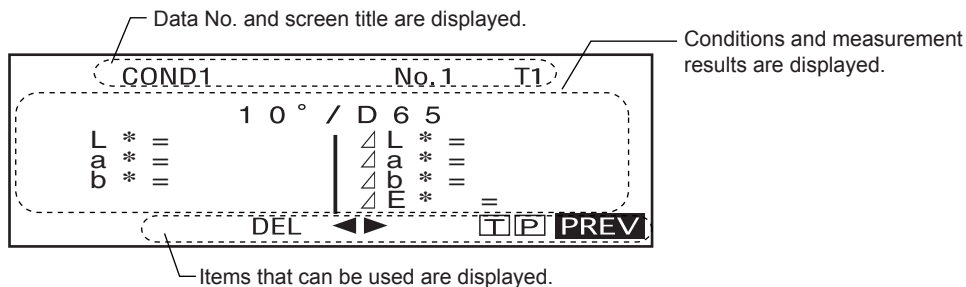

Battery Alarm

When using CM-2500c with batteries, battery alarm indication appears when their power level lowers.

 [Half battery indication]

If this indication (Half battery indication) appears, new batteries should be prepared for replacement in near future. Even with this indication displayed, measurements are still possible.

 [Empty battery indication]

If this indication (Empty battery indication) appears, measurement or calibration is no longer possible. Replace batteries with new ones.

Data Saving

Data used with this instrument is saved automatically. Although white calibration data is retained in internal memory even after power is turned off, it is still necessary to repeat white calibration each time you switch the power back on.



Chapter 2

Preparation for Measurement

Flow of Measurement

For the first time

Turning Power On for the First Time
(see page E-23)



Initial Setting (see page E-25)



Selecting a Measurement Condition (see page E-29)



Setting a Measurement Condition
(see page E-30)



Zero Calibration (see page E-38)



White Calibration (see page E-40)

When Checking Color Difference

When Not Checking Color Difference

Setting a Color Difference
Target Data (see page E-42)



Selecting a Color Difference
Target Data (see page E-45)



Measurement (see page E-56)



Complete Measurement

For the second and subsequent times

Turning Power ON (see page E-17)



Selecting a Measurement Condition (see page E-29)



White Calibration (see page E-40)

When Checking Color Difference

When Not Checking Color Difference

Setting a Color Difference
Target Data (see page E-42)



Selecting a Color Difference
Target Data (see page E-45)



Measurement (see page E-56)



Complete Measurement

Turning Power On for the First Time

When turning the power ON for the first time, the display language must be set.

Setting the Language Mode

Set the language mode as follows:

[Setting Procedure]

1 While pressing , turn the power ON.

The <INITIAL SETTING> screen will appear, with the item “LANGUAGE” highlighted.

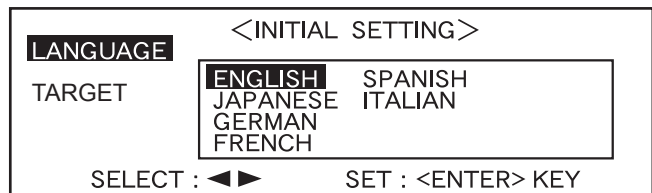
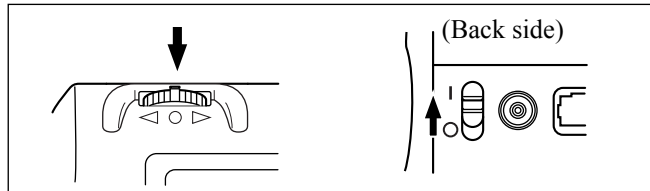

2 Turn to select the desired language, then press .

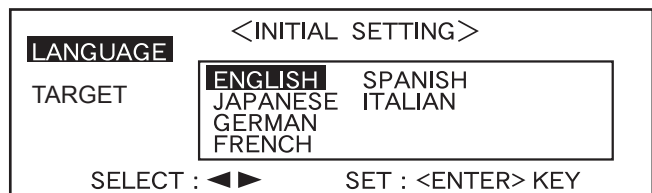

- When the cursor moves to the desired language, all the text will be displayed in the selected language.

Selecting the Target Mode

The default setting is “linked to each data.” mode. The following procedure is required only if you want to switch the target mode.

[Note]

- If the Color Data Software “SpectraMagic (CM-S9w)” is used, switch the target mode to “defined in COND.” mode.
- Once the target mode is changed, previous data will be cleared. It is recommended that you save previous data into other storage media in advance by using the Color Data Software that is optionally available.

[Setting Procedure]

- 1** Turn  to select the desired target mode, then press .

[Memo]

If you do not want to change the target mode, press .

- The default setting is “linked to each data.”

A warning message is displayed.

<INITIAL SETTING>	
LANGUAGE	
TARGET	linked to each data. defined in COND.
SELECT : ◀▶	SET : <ENTER> KEY

Measurement data and color difference target color data stored in the instrument are all deleted.
Are you sure to delete all data?

YES

NO

- 2** Turn  to select “Yes”, then press .

The <INITIAL> screen will appear.

<INITIAL>	
COND1	
COND2	
COND3	
COND4	
COND5	
COND6	
	MENU

[Memo]

If you select “No” and press , you will return to the screen shown in **1**.

Initial Setting

The following five initial setting items are available.

- (1) REMOTE..... Connects the instrument to the PC to enable bi-directional communications.
- (2) AUTO PRINT..... If the instrument is connected to a printer, measured data will be printed automatically each time measurement is taken.
- (3) CLOCK..... Adjusts the instrument's built-in clock.
- (4) DISPLAY INVERT..... Reverses the display direction.
- (5) LCD CONTRAST Adjusts the LED's contrast.

[Memo]

“(1) REMOTE” and “(2) AUTO PRINT” can be used when connecting the instrument to a PC or printer.



The settings will be kept even if the power is turned OFF.

To make initial settings, follow the procedure given below:

[Setting Procedure]

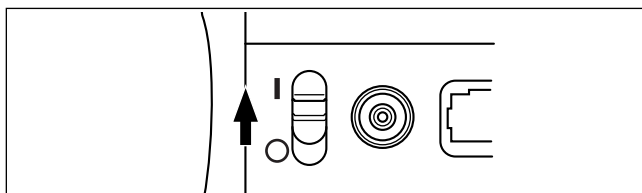
- 1** Turn the power ON.



- 2** Turn  to select “MENU”, then press .



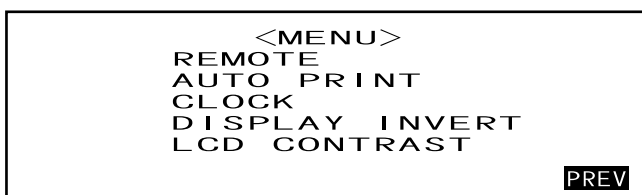

The <MENU> screen will appear.
The initial settings can be made in this screen.



Setting the Date and Time

[Setting Procedure]

<MENU> screen

- 1 Turn  to select "CLOCK", then press .

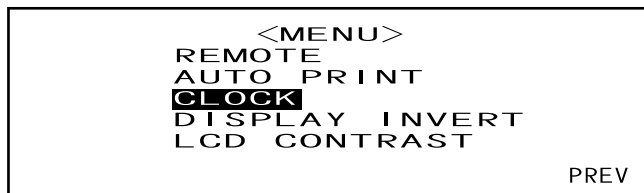

- 2 Turn  to select "ADJUST", then press .

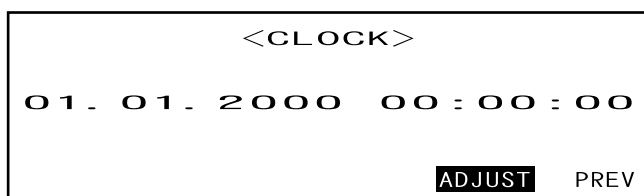

The cursor will move to the currently set date, allowing you to change it.



- 3 Turn  to select the desired date and time, then press .

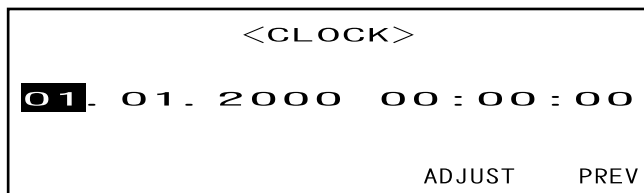

The selected date and time will be set.



- Each time  is pressed, the cursor will move as follows: "day" → "month" → "year" → "hour" → "minute" → "second" → "PREV"
- Keeping  held down to left or right will cause the date/time to change continuously.
- To change the entries, restart from step 2.

<Settings>

- **Day:** 01 to 28, 29, 30, 31 (varies with the selected month)
- **Month:** 01 to 12
- **Year:** 00 to 99 (lower two digits)
- **Hour:** 00 to 23
- **Minute:** 00 to 59
- **Second:** 00 to 59

- 4 Turn  to select "PREV", then press .

The settings you made at step 3 will be confirmed, and the <MENU> screen will reappear.

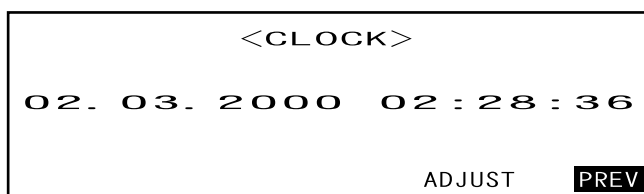



Setting the Display Direction

[Setting Procedure]

<MENU> screen

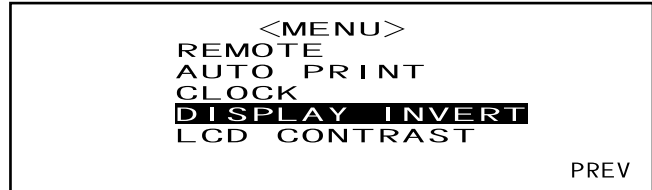
- 1 Turn  to select "DISPLAY INVERT", then press .



The contents displayed on the LCD will be reversed each time  is pressed.

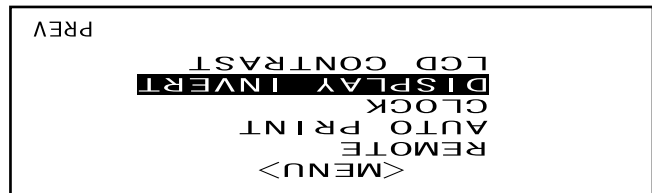

Setting the LCD Contrast

[Setting Procedure]

<MENU> screen

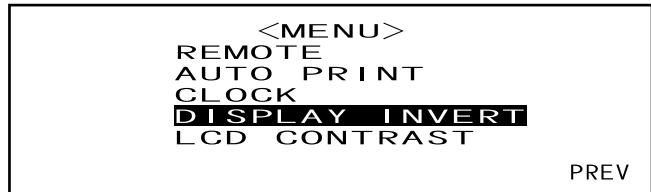

- 1 Turn  to select "LCD CONTRAST", then press .

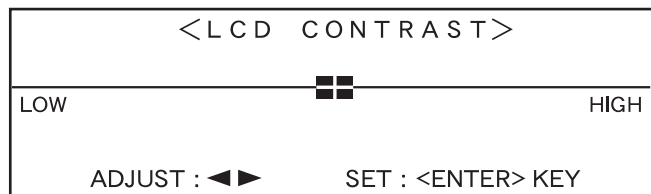

- 2 Turn  to adjust the LCD contrast, then press .

The contrast you set will be confirmed, and the <MENU> screen will reappear.



- Turning  to the right will move the contrast adjuster bar to the right, increasing the contrast. Turning  to the left will move the contrast adjuster bar to the left, decreasing the contrast.
- Keeping  held down to left or right will cause the contrast adjuster bar to move continuously.

Note

On the LCD of this instrument, the display looks darker in a high temperature environment, and looks paler in a low temperature environment. When this occurs, adjust the display level so that the display shows its contents properly.

If the contrast is too high or too low, the contents displayed on the LCD cannot be viewed properly. In this case, turn the power OFF, and then turn it ON again while pressing . The default contrast will be stored and the screen shown in "Setting the Language Mode" (page E-23) will appear. Adjust the LCD contrast again as explained in "Initial Setting" (from page E-25) if necessary.

Selecting a Measurement Condition

Before starting measurement, the desired measurement condition (COND1 to COND6) must be selected.

[Memo]



- Up to six sets of measurement conditions (COND1 to COND6) can be set.
- Measurement conditions must be set before start of measurement. For details, refer to page E-30.

[Setting Procedure]

<INITIAL> screen

- 1 Turn  to select one of the conditions (COND1 to COND6), then press .





- 2 Turn  to select "FILE", then press .



- "T*" is the number of the color difference target data for the next measurement. If nothing is selected, "T--" appears.
- "T*" does not appear if "defined in COND." mode is selected.

The currently selected measurement condition will be displayed.



- The FILE screen consists of two pages (1/2 and 2/2).
- The pages can be switched from one to another by turning  to select "▶ 2/2" (or "▶ 1/2") and then pressing .

[Memo]

- To set a new condition or change an existing condition, refer to "Setting a Measurement Condition" on the following page.
- If a measurement condition has been set, calibration and measurement can be performed under that condition.

Setting a Measurement Condition

Up to six sets of conditions (COND1 to COND6) can be set. Since the instrument will perform measurement according to the selected condition, conditions must be set before start of measurement. The following seven condition items can be set:

- (1) Illuminant 1, illuminant 2 “ILLUMINANT 1, ILLUMINANT 2”
- (2) Observer “OBSERVER”
- (3) Display contents “DISPLAY”
- (4) Color space “COLOR SPACE”
- (5) Measurement times and standard deviation for manual averaging “MANUAL AVG. TIMES” and “DEVIATION”
- (6) Auto averaging times “AUTO AVG.”
- (7) Delay time “DELAY TIME”

[Memo]

- A setting can be made for the currently highlighted item. To confirm the setting, press . The next item will be highlighted automatically.
- For the items for which no setting needs to be made, press to skip them.
- If an incorrect setting has been made for items (1) to (7), press the MEAS. button. This will take you to the previous items and allow you to make a correct setting.

[Setting Procedure]

<FILE> screen

- 1 Turn to select “SEL”, then press .

COND1	<FILE>	1/2
ILLUMINANT1	D65	
ILLUMINANT2	---	
OBSERVER	10°	
DISPLAY	DIFF&ABS	
SEL ▶2/2 BREAK PREV		

“ILLUMINANT 1” will be highlighted.

COND1	<FILE>	1/2
ILLUMINANT1	D65	F2 F10
ILLUMINANT2	D50	F6 F11
OBSERVER	C	F7 F12
DISPLAY	A	F8
↑ : <MEAS.> BUTTON		

Selecting Illuminant 1

2 Turn  to select the desired illuminant, then press .

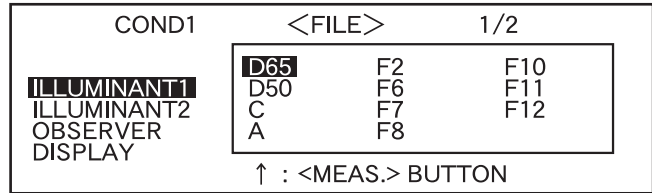

<Settings>

- **D65**: Standard illuminant D65; daylight, Color temperature: 6504K
- **D50**: Complementary illuminant D50; daylight, Color temperature: 5003K
- **C**: Complementary illuminant C; daylight (Ultraviolet part is small in comparison with the daylight), Color temperature: 6774K
- **A**: Standard illuminant A; Incandescent lamp, Color temperature: 2856K
- **F2**: Cool white (fluorescent lamp)
- **F6**: Cool white (fluorescent lamp)
- **F7**: Color rendering A daylight white (fluorescent lamp)
- **F8**: Color rendering AAA natural white (fluorescent lamp)
- **F10**: 3-band type natural white (fluorescent lamp)
- **F11**: 3-band type cool white (fluorescent lamp)
- **F12**: 3-band type warm white (fluorescent lamp)
- ---: None (Not selectable “ILLUMINANT 1”)

Selecting Illuminant 2

3 As explained in “Selecting Illuminant 1”, select the desired illuminant, then press .

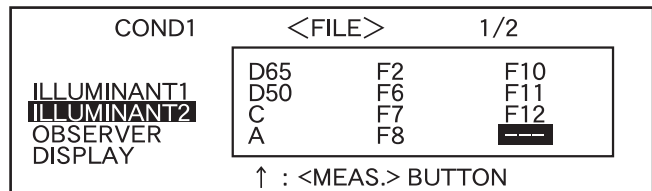

<Settings>

- Same as those given in “Selecting Illuminant 1”
- To display MI (metamerism index), an illuminant must be selected for ILLUMINANT 2.

Selecting the Observer

4 Turn  to select the desired observer angle, then press .

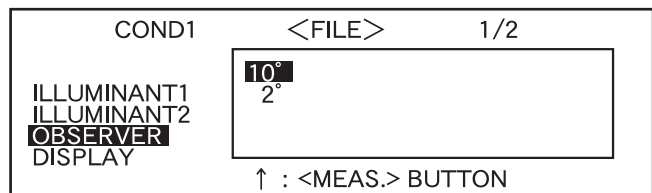

<Settings>

- **10°**: 10° observer (CIE1964)
- **2°**: 2° observer (CIE1931)

Selecting the Display Mode

5 Turn  to select the desired display mode, then press .

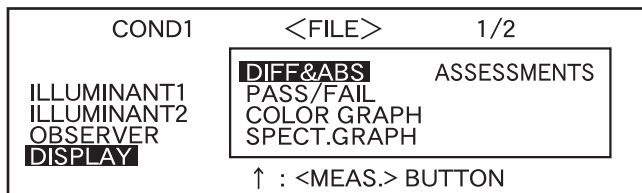

<Settings>

- **DIFF&ABS:**

Displays the absolute value and the color difference in relation to the target color. (Only absolute value or only color difference can be displayed.)

If pass/fail judgment is made according to the specified box color difference tolerances, the failed factor of the measured data will be highlighted.

- **PASS/FAIL:**

Whether color difference from the target colors is within the specified color difference limit is judged. "PASS" will be displayed if the color difference is within the specified limit for all items of the measured data, and "FAIL" will be displayed if not within the specified limit for any factor of the measured data.

- **COLOR GRAPH:**

Displays the color difference from the target value in a graph. (Only for illuminant 1, box tolerance and L*a*b*)

- **SPECT. GRAPH:**

Displays a spectral reflectance graph.

- **ASSESSMENTS**

The color difference from the target color, pass/fail judgment result made based on the specified tolerances and direction of deviation from the target color for each axis in the L*a*b* or L*C*h color space are displayed.

- If no color target has been selected, the color difference, pass/fail judgment result and tint deviation direction will not be displayed even if "ASSESSMENTS" is selected. Furthermore, if no tolerances are selected, the pass/fail judgment result and deviation direction will not be displayed even if the target color is selected.

- Even if "DIFF&ABS" or "COLOR GRAPH" is selected, no color difference values will be displayed if no color difference target data have been selected.

Selecting a Color Space

6 Turn to select the desired color space, then press .

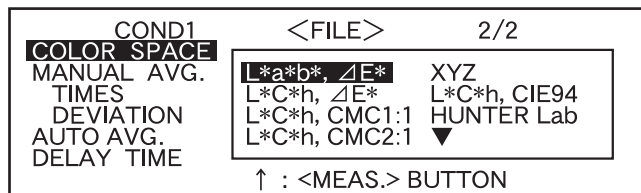

Locating the highlighted cursor to ▼ by turning  will display the next page of the color space list.

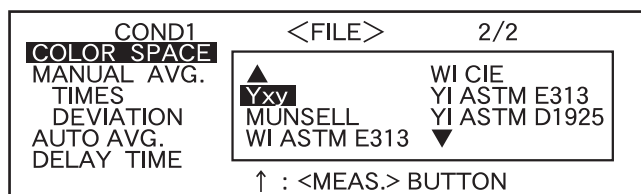

Locating the highlighted cursor to ▲ by turning  will display the previous page of the color space list.

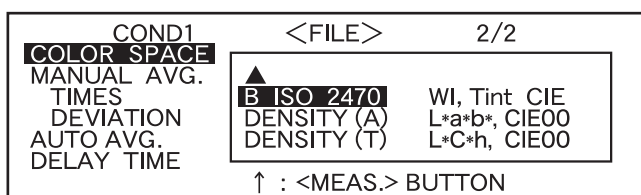



<Settings>

- **L*a*b*, ΔE***: L*a*b* color space and color difference by “ΔE*ab (CIE1976)” color-difference formula
- **L*C*h, ΔE***: L*C*h color space and color difference by “ΔE*ab (CIE1976)” color-difference formula
- **L*C*h, CMC1:1**: L*C*h color space and color difference by “CMC1:1” color-difference formula
- **L*C*h, CMC2:1**: L*C*h color space and color difference by “CMC2:1” color-difference formula
- **XYZ**: XYZ color space
- **L*C*h, CIE94**: L*C*h color space and color difference by “ΔE*94 (CIE1994)” color-difference formula
- **Hunter Lab**: Hunter Lab
- **Yxy**: Yxz color space
- **MUNSELL**: Munsell color notation
- **WI ASTM E313**: Whiteness (ASTM E313-73)
- **WI CIE**: Whiteness Index
- **YI ASTM E313**: Yellowness Index (ASTM E313-73)
- **YI ASTM D1925**: Yellowness Index (ASTM D1925)
- **B ISO 2470**: ISO Brightness
- **DENSITY (A)**: Density (status A)
- **DENSITY (T)**: Density (status T)
- **WI, Tint CIE**: Whiteness Index and Tint value (CIE)
- **L*a*b*, CIE00**: L*a*b* color space and color difference by “ΔE00 (CIE2000)” color-difference formula
- **L*C*h, CIE00**: L*C*h color space and color difference by “ΔE00 (CIE2000)” color-difference formula
- If L*a*b* or L*C*h is selected as the color space, DIFF&ABS or PASS/FAIL as the display mode and ILLUMINANT 1 or ILLUMINAT 2 as the illuminant, it will be possible to calculate MI (metamerism index) and display the result.
- The coefficient for CIE00 (kl:kc:kh) is (1:1:1). This can be changed using SpectraMagic NX (except for Ver. 1.50 or earlier).
 If the coefficient (kl:kc:kh) is re-specified after measurement, the measurement data will be replaced with data calculated based on the new coefficient.

Setting the Number of Measurements for Manual Averaging

Manual averaging settings can be made as follows: For details, refer to “Manual Averaging” (page E-70).

- 7** Turn  to select the number of measurements to be performed, then press .

COND1	<FILE>	2/2
COLOR SPACE	L*a*b*	△E*
MANUAL AVG.		
TIMES	3	
DEVIATION	0.20	
AUTO AVG.	3	
DELAY TIME	0.0s	
	↑ : <MEAS.> BUTTON	

<Settings>

• **TIMES:**

Specify the number of measurements to be performed (2 to 30).

If “-” is selected, manual averaging will not be performed.

- Keeping  held down to left or right will cause the value to change continuously.

Setting the Standard Deviation for Manual Averaging

- 8** Turn  to set the desired standard deviation, then press .

COND1	<FILE>	2/2
COLOR SPACE	L*a*b*	△E*
MANUAL AVG.		
TIMES	3	
DEVIATION	0.20	
AUTO AVG.	3	
DELAY TIME	0.0s	
	↑ : <MEAS.> BUTTON	

<Settings>

• **DEVIATION:**

Set the desired standard deviation (0.01 to 2.00). When the standard deviation is below the specified value, the average of the measured values taken so far will be calculated and used as the measurement result.

If “-” is selected, manual averaging by the standard deviation will not be performed.

- If “-” has been set for TIMES, “- - -” will also be set for DEVIATION and cannot be changed.
- If the spectral graph has been selected as the display mode, “- - -” will be set for DEVIATION and can not be changed.
- The standard deviation can be set only if L*a*b* or L*C*h has been set as the color space.
- The standard deviation cannot be set if “SPECT. GRAPH” has been selected as the display mode.
- Manual averaging will end when either the specified number of measurements (TIMES) or the specified standard deviation (DEVIATION) is reached.
- Keeping  held down to left or right will cause the value to change continuously.

Setting the Number of Measurements for Auto Averaging

- 9 Turn  to select the number of measurements to be performed, then press .

COND1	<FILE>	2/2
COLOR SPACE		
MANUAL AVG.		
TIMES	1	
DEVIATION	3	
AUTO AVG.	5	
DELAY TIME	8	
	↑ : <MEAS.> BUTTON	

<Settings>

- Specify the number of measurements to be performed (1, 3, 5 or 8).

Setting the Delay Time

- 10 Turn  to set the desired delay time, then press .

COND1	<FILE>	2/2
COLOR SPACE	L*a*b*, ΔE*	
MANUAL AVG.		
TIMES	3	
DEVIATION	0.20	
AUTO AVG.	3	
DELAY TIME	0.0s	
	↑ : <MEAS.> BUTTON	

<Settings>

• **DELAY TIME:**

The delay time is used to prevent influences caused by movement of the hands, and is the duration from when the MEAS. button is pressed until the lamp flashes and measurement is performed. Specify the desired delay time (0.1 to 3.0 seconds in steps of 0.1 seconds). If “0.0” (second) is specified, no delay time will be provided.

- Keeping  held down to left or right will cause the value to change continuously.

“BREAK” will be highlighted.

COND1	<FILE>	2/2
COLOR SPACE	L*a*b*, ΔE*	
MANUAL AVG.		
TIMES	3	
DEVIATION	0.20	
AUTO AVG.	3	
DELAY TIME	0.0s	
	SEL ▶1/2	BREAK PREV

11

<Performing Calibration>

Turn  to select "PREV", then press .

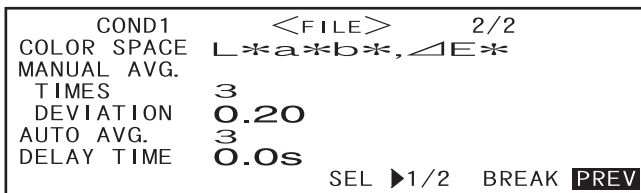

Setting will be completed and the <COND*> screen will appear.



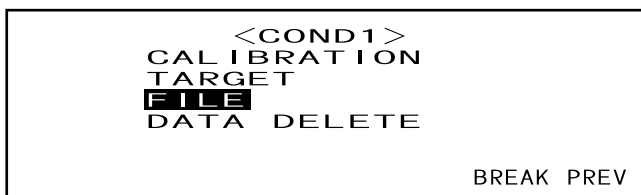

- "T*" is the number of the color difference target data for the next measurement. If nothing is selected, "T--" appears.



- "T*" does not appear if "defined in COND." mode is selected.

Memo

Selecting "CALIBRATION" by turning  and pressing  will display the <CALIBRATION> screen. So, perform the desired calibration according to step 3 and subsequent steps given in "Zero Calibration" (from page E-38) or "White Calibration" (from page E-40).

Note

Depending on the target mode selected, some of the options displayed will be different.

<Performing Measurement>

Turn  to select "BREAK", then press .

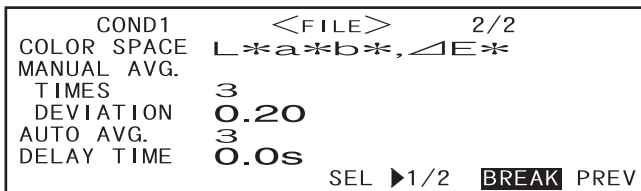

The <measurement> screen will appear.

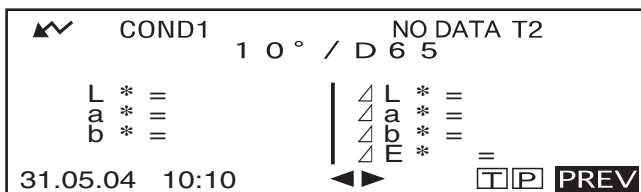

<Setting a Measurement Condition for another <COND*>

Turn  to select "PREV", then press .

Measurement condition setting will be complete, and the <COND*> screen will reappear.

```

COND1          <FILE>          2/2
COLOR SPACE   L*a*b*, ΔE*
MANUAL AVG.
TIMES         3
DEVIATION     0.20
AUTO AVG.     3
DELAY TIME    0.0s
SEL ▶1/2     BREAK PREV

```

```

          <COND1 >
CALIBRATION
TARGET      T*
FILE
DATA DELETE
                                     BREAK PREV

```

- "T*" is the number of the color difference target data for the next measurement. If nothing is selected, "T--" appears.

```

          <COND1 >
CALIBRATION
TARGET
FILE
DATA DELETE
                                     BREAK PREV

```

- "T*" does not appear if "defined in COND." mode is selected.

Selecting "PREV" by turning  and pressing  again will cause the <INITIAL> screen to reappear.

So, set another measurement condition according to the procedure given in "Selecting a Measurement Condition" and "Setting a Measurement Condition" (from page E-29).

```

          <INITIAL >
COND1
COND2
COND3
COND4
COND5
COND6
                                     MENU

```

Zero Calibration

When you use this instrument for the first time or when you have initialized it, zero calibration must be performed.

Once zero calibration is completed, the zero calibration data will be kept even if the power is turned OFF. Thus, it is not necessary to perform zero calibration each time the power is turned ON.

[Memo]

- The effects of stray light inside this instrument (i.e. light generated due to the flare characteristics of the optical system) will be compensated automatically by the zero calibration data.
- The amount of stray light may change because of dust or dirt which has collected in the optical system, temperature, repeated operation, vibration and shock exerted on the instrument. In this case, performing zero calibration periodically is recommended.

[Note]

- *If the instrument is not used for long periods of time, the zero calibration data stored in the instrument may be lost. If the data is lost, zero calibration must be performed again.*

[Setting Procedure]

<INITIAL> screen

- 1 Turn  to select one of the conditions (COND1 to COND6), then press .

```
                <INITIAL>
COND1
COND2
COND3
COND4
COND5
COND6
                MENU
```

- 2 Turn  to select "CALIBRATION", then press .

```
                <COND1>
CALIBRATION
TARGET      T*
FILE
DATA DELETE
                BREAK  PREV
```

- "T*" is the number of the color difference target data for the next measurement. If nothing is selected, "T--" appears.

```
                <COND1>
CALIBRATION
TARGET
FILE
DATA DELETE
                BREAK  PREV
```

- "T*" does not appear if "defined in COND." mode is selected.

- 3 Turn  to select "ZERO".

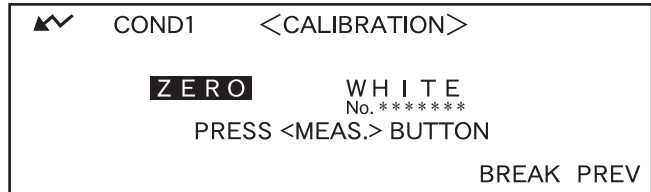

- 4 Direct the specimen measuring port into the air.

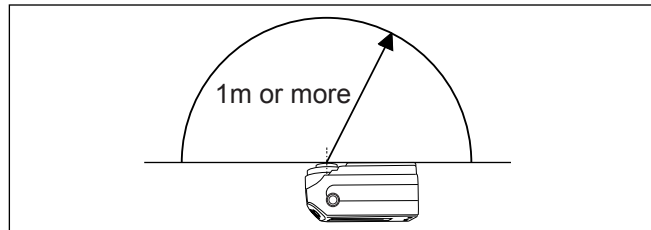

- Never place the specimen measuring port toward a light source.
- Keep the specimen measuring port more than 1m away from any reflective items (hands, desks, walls etc.).



- 5 Make sure that  is displayed, then press  (MEAS. button).

Zero calibration will be performed.

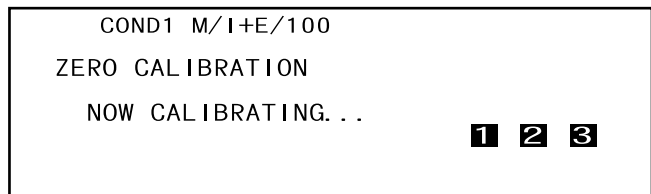
When zero calibration is complete, the <CALIBRAITON> screen will reappear.



Memo

- Use of the optional Zero Calibration Box ensures proper zero calibration.
- If  does not appear due to the auto power save function, this may be due the fact that it can take time to start zero calibration after  is pressed.

Note

- *When zero calibration is complete, perform white calibration. Measurement cannot be performed if white calibration has not been completed.*
- *Even though white calibration has been performed after the power is turned ON, if zero calibration has also been performed after that, white calibration must be performed again.*

White Calibration

White calibration must be performed prior to start of measurement after the power is turned ON.

[Memo]

- Own calibration data has been registered to the White Calibration Plate supplied with the instrument.
- White calibration must be performed every time you turn on the CM-2500c.
- The reading may fluctuate slightly due to changes in the ambient temperature or due to heat generation caused by repeated operation of the instrument. In this case, make sure to perform white calibration regularly.
- White calibration is not required if you just want to see the measured data without performing measurement.

[Note]

- *White calibration must be performed at the same temperature as the one at which measurement will be performed.*
- *Before starting white calibration, make sure that the instrument is sufficiently acclimatized to the ambient temperature.*

[Setting Procedure]

<INITIAL> screen

- 1** Turn  to select one of the conditions (COND1 to COND6), then press .

```
          <INITIAL>
COND1
COND2
COND3
COND4
COND5
COND6
          MENU
```

- 2** Turn  to select "CALIBRATION", then press .

```
          <COND1>
CALIBRATION
TARGET      T*
FILE
DATA DELETE
          BREAK  PREV
```

- "T*" is the number of the color difference target data for the next measurement. If nothing is selected, "T--" appears.

```
          <COND1>
CALIBRATION
TARGET
FILE
DATA DELETE
          BREAK  PREV
```

- "T*" does not appear if "defined in COND." mode is selected.

3 Turn to select "WHITE".

Note that the White Calibration Plate No. is displayed.

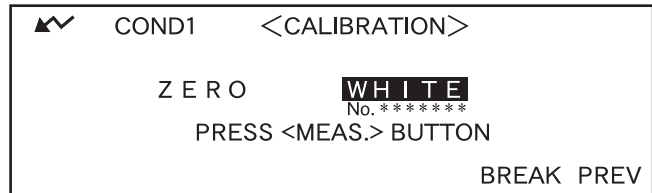

4 Place the instrument on the correct White Calibration Plate (i.e. the calibration plate whose plate No. is displayed in the screen).

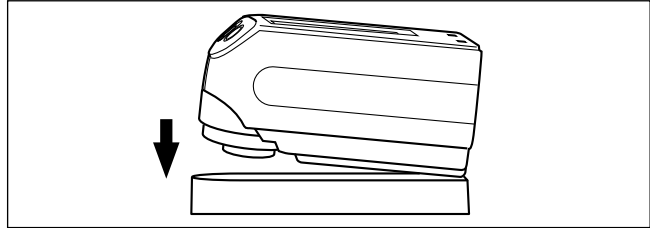

5 Make sure that is displayed, then press (MEAS. button).

White calibration will be performed.

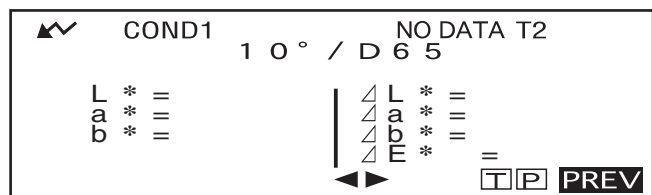
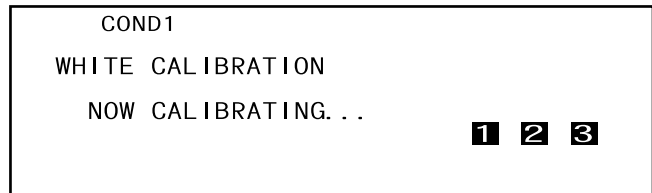

When white calibration is complete, the measurement screen will reappear.



Note

The instrument's memory contains the calibration data of the White Calibration Plate supplied with instrument. Therefore, the White Calibration Plate bearing the same serial number as that shown on the <CALIBRATION> screen must be used for white calibration.

Memo

- In COND mode, the measurement screen can still be displayed even if white calibration has not been completed. However, it will not be possible to take measurement. (Measured data can still be viewed.)
- White calibration must be performed each time the power is turned ON.
- To perform white calibration again after the measurement screen is displayed, select "PREV" to return to <COND*> screen, then restart the procedure from step 2.
- Even if the conditions are changed (e.g. switched from COND2 to COND3) following white calibration, it will be not necessary to perform white calibration again.
- If  does not appear due to the auto power save function, this may be due the fact that it can take time to start white calibration after  is pressed.

Setting a Color Difference Target Data

To measure the color difference between two specimens, the color of one of the specimens must be set as the target color. Up to 1700 target colors can be set for color difference measurement. (700 can be set in the “defined in COND.” mode.)

To set a target color, follow the procedure given below.

[Memo]

- Since tolerances for pass/fail judgment need to be set for each target color, target color data must be set before setting tolerances.
- The memory of this instrument can store up to 1700 pieces of data in total, (700 in the “defined in COND.” mode). This amount includes the sample data and color difference target data. When some sample data have already been stored, the number of target colors which can be set will be reduced by the number of the sample data.

[Note]

- *Before setting target colors, a measurement condition (COND1 to COND6) must be selected and white calibration performed.*
- *For accurate measurement, make sure to keep measurement conditions (ambient temperature etc.) constant.*

[Setting Procedure]

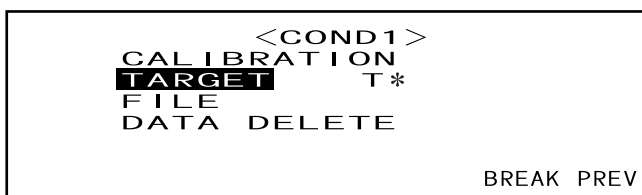

<COND*> screen

- 1 Turn  to select “TARGET”, then press .



- “T*” is the number of the color difference target data for the next measurement. If nothing is selected, “T--” appears.
- “T*” does not appear if “defined in COND.” mode is selected.

- 2 Turn  to select  , then press .

  will change to .

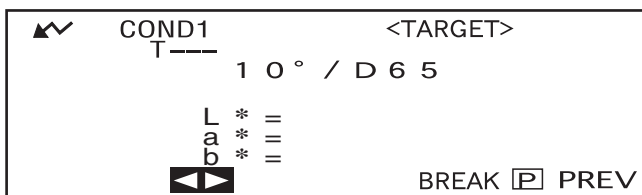

- “T1” appears instead of “T--” if “defined in COND.” mode is selected.

- 3** Turn  to select the desired target color no. (T*), then press .   will return to  .

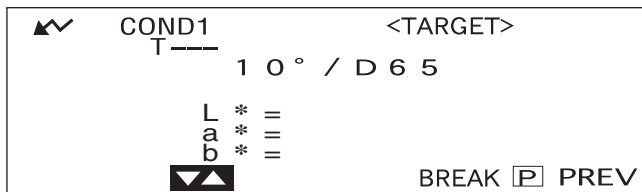

- Keeping  held down to left or right will cause the target color No. to change continuously.

- 4** Place the specimen measuring port to the specimen.

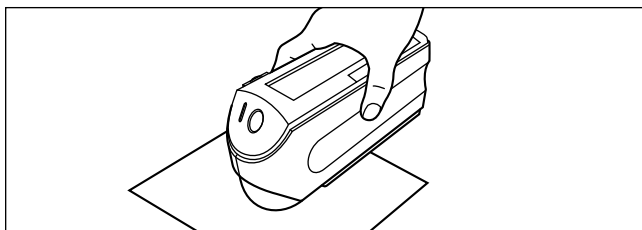

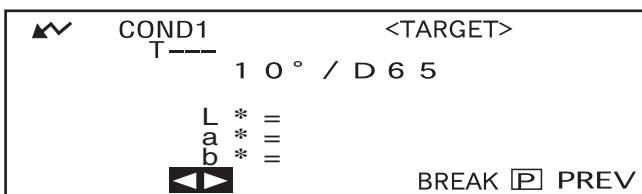

- 5** Make sure that  is displayed, then press  (MEAS. button).

The lamp will flash, measurement will be taken, then the result will appear on the LCD.



[Memo]

- The navigation wheel and MEAS. button cannot be used for four seconds after the MEAS. button is pressed (when the AC adapter or a new battery is used).
- If  does not appear due to the auto power save function, this may be due the fact that it can take time to start measurement after  is pressed.



- 6** Turn  to select “BREAK” or “PREV”, then press .

To set the next target color, repeat steps 2 to 5.

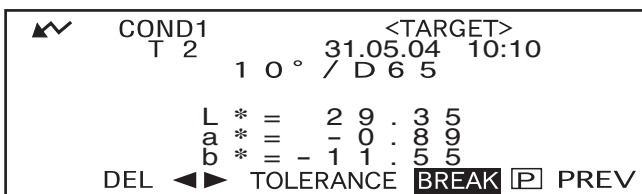

To exit target color setting, select “PREV”.



[Memo]

- If a target color has already been set for the selected target color no., a message asking you whether you wish to overwrite the target color data will appear. Select “YES” to overwrite (or select “NO” if not) using , then press .
- If “MUNSELL”, “DENSITY (A)” or “DENSITY (T)” has been selected as the color space, it will be possible to set target colors, but no color difference data will be displayed in the measurement screen. In addition, it is not possible to set color difference tolerances.
- If “COLOR GRAPH” has been selected as the display mode, it will be possible to set target colors, but color difference cannot be displayed in the measurement screen.
- Measurement will no longer be possible once the total number of target color data and measured data reaches 1700 (and 700 in the “defined in COND.” mode). In this case, delete some target color data or measured data.

Switching between the Measured Data screen and the <TARGET> screen

Turning  to select "T" and then pressing  will cause the measured data screen to change to the <TARGET> screen showing the color difference target data for the currently selected target number which is the target will be used for the next measurement.

```

    ▲▼ COND1          No. 4   T2
      1 0 ° / D 6 5

    L * = 9 9 . 3 9 | Δ L * = 6 8 . 0
    a * = - 0 . 0 8 | Δ a * = 0 . 8 0
    b * = - 0 . 1 0 | Δ b * = 1 1 . 8
31.05.04 10:10 DEL ◀▶ DISP T P PREV
  
```

Note

If "SPECT. GRAPH" has been selected as the display mode, "T" will not be displayed in the Measured Data screen. Similarly, "BREAK" will not be displayed in the <TARGET> screen. Thus, switching from the Measured Data screen to <TARGET> screen or vice versa, back to the <COND*> screen once, must be carried out by the method to select the desired screen.

```

    ▲▼ COND1          <TARGET>
      T 2            31.05.04 10:10
      1 0 ° / D 6 5

    L * = 2 9 . 3 5
    a * = - 0 . 8 9
    b * = - 1 1 . 5 5
    DEL ◀▶ TOLERANCE BREAK P PREV
  
```

Selecting a Color Difference Target Data

To measure the color difference between two specimens, the target color to be used for measurement must be selected from those set in “Setting a Color Difference Target Data”.

To select a target color, follow the procedure given below.

[Setting Procedure]

<COND*> screen

- 1 Turn  to select “TARGET”, then press .

```
          <COND1>
CALIBRATION
TARGET      T*
FILE
DATA DELETE

                                BREAK PREV
```

- “T*” is the number of the color difference target data for the next measurement. If nothing is selected, “T--” appears.
- “T*” does not appear if “defined in COND.” mode is selected.

- 2 Turn  to select “◀▶”, then press .
- “◀▶” will change to “▼▲”.

```
▲▼  COND1          <TARGET>
      T 2          31.05.04 10:10
           1 0° / D 6 5

      L * = 2 9 . 3 5
      a * = - 0 . 8 9
      b * = - 1 1 . 5 5

DEL  ◀▶ TOLERANCE BREAK [P] PREV
```

- 3 Turn  to select the desired target color no. (T*), then press .
- “▼▲” will return to “◀▶”.

```
▲▼  COND1          <TARGET>
      T 2          31.05.04 10:10
           1 0° / D 6 5

      L * = 2 9 . 3 5
      a * = - 0 . 8 9
      b * = - 1 1 . 5 5

DEL  ▼▲ TOLERANCE BREAK [P] PREV
```

- Keeping  held down to left or right will cause the target color No. to change continuously.

4 <Performing Measurement>

- Turn  to select “BREAK”, then press .

The measurement screen will appear.

```
▲▼  COND1          <TARGET>
      T 2          31.05.04 10:10
           1 0° / D 6 5

      L * = 2 9 . 3 5
      a * = - 0 . 8 9
      b * = - 1 1 . 5 5

DEL  ◀▶ TOLERANCE BREAK [P] PREV
```

Note

To make pass/fail judgment during measurement, it is necessary to set tolerances for the target color to be used. For details, refer to “Setting Color Difference Tolerances” (page E-47).

Deleting a Color Difference Target Data



There are two methods for deleting target color data. One is to delete the target color data set in “T*” of the measurement conditions (COND 1 to COND 6) one by one. The other is to delete all the target color data set in the instrument.

Note

- When target color data is deleted, its tolerances will also be deleted.
- You will not be able to view the color difference for measurement data that used the deleted target color data.

[Setting Procedure]

Display the target color data to be deleted, as explained in “Setting a Color Difference Target Data”.

- 1 Turn  to select “DEL”, then press .

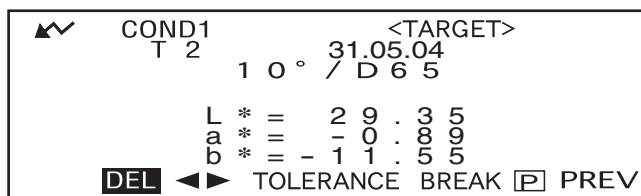

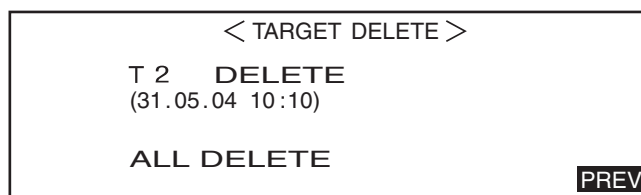

- 2 Turn  to select the desired deletion method, then press .



Deletion Method

• **T* DELETE:**

Deletes the currently displayed target color data.

- If the target color data to be deleted by another “COND*” has been selected, a message “THIS TARGET IS USED IN OTHER COND. DO YOU DELETE IT?” will appear. Select “YES” if you want to delete or select “NO” if not, using , then press .
- The target color data nos. next to that of the deleted target color data will scroll up automatically.

• **ALL DELETE:**

Deletes all the target color data currently set in the instrument. All the target color data will be deleted without a confirmation message.

Note

If the target mode is “linked to each data.,” “T---” is displayed for target color number if the target color linked at the time of measurement is deleted, and the color difference for that data cannot be displayed.

Setting Color Difference Tolerances

This instrument allows you to set tolerances for the measured color difference, to make pass/fail judgment. Pass/fail judgment is made based on two types of tolerances: box tolerances and elliptical tolerances. Prior to start of measurement, tolerances must be set.

Memo

- Two types of tolerances are available (box tolerances and elliptical tolerances). With this instrument, either box or elliptical tolerances can be set for each target color. However, the following restrictions apply to the tolerance type that can be set, depending on the selected color space.
- In the case of “MUNSELL” and “DENSITY” as the Color Space, neither box nor elliptical tolerances can be set.
- In the case of “WI”, “YI”, “ISO BRIGHTNESS” and “WI/Tint” as the Color Space, only box tolerances can be set.
- In the case of “Spect. Graph” as the Display Mode, neither box nor elliptical tolerance can be set.

Note

Once tolerances are set, the tolerance type cannot be changed. To change the tolerance type, the currently set tolerances must be cleared.

Box Tolerance

If the measured color difference is outside the specified tolerances set for the target color, it will be highlighted to indicate that the pass/fail judgment result is FAIL. Both + and - box tolerances can be set for each target color.

Note

Target colors must be set before setting tolerances.

[Setting Procedure]

<COND*> screen

- 1 Turn  to select “TARGET”, then press .

```

          <COND1>
CALIBRATION
TARGET      T*
FILE
DATA DELETE

                                BREAK  PREV
  
```

- “T*” is the number of the color difference target data for the next measurement. If nothing is selected, “T--” appears.
- “T*” does not appear if “defined in COND.” mode is selected.

- 2 Turn  to select “◀▶”, then press .
- “◀▶” will change to “▼▲”.

```

  ✓ COND1          <TARGET>
    T 2           31.05.04  10:10
      1 0° / D 6 5

      L * = 2 9 . 3 5
      a * = - 0 . 8 9
      b * = - 1 1 . 5 5
DEL  ◀▶ TOLERANCE  BREAK  [P]  PREV
  
```

3 Turn  to select the desired target color no. (T*), then press .

“▼▲” will return to “◀▶”.

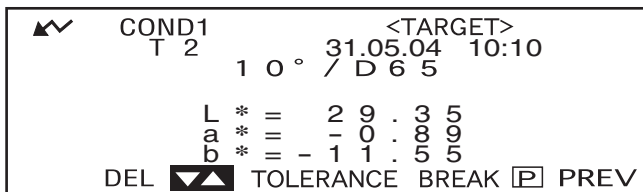



• Keeping  held down to left or right will cause the target color No. to change continuously.

4 Turn  to select “TOLERANCE”, then press .

A screen that allows selection of the tolerance type will appear.

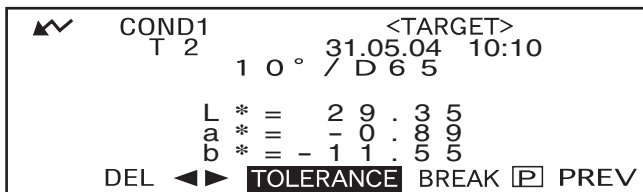
If tolerances have already been set, they will be displayed, so skip to step 6.



5 Turn  to select “BOX”, then press .



6 Turn  to select “ADJUST”, then press .

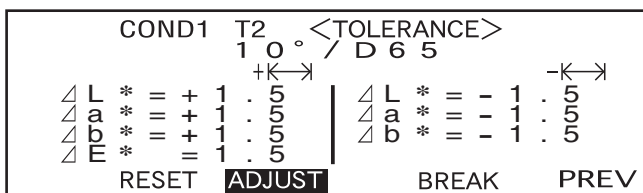

7 Turn to select the value for an item to be set, then press .



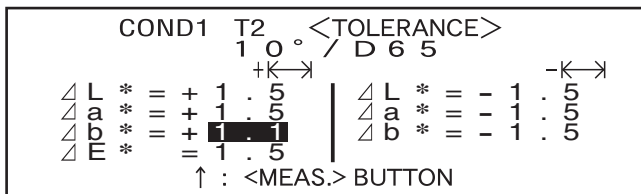

The selected value will be set, and the cursor will move to the next value.



Memo

Keeping  held down will cause the cursor to move from one value to another continuously. The cursor will stop when it reaches "ADJUST".

<Settings>

- + ("+" tolerance range) : "----" (No setting), 0.1 to 20.0
- - ("-" tolerance range) : "----" (No setting), 0.1 to 20.0
- Keeping  held down to left or right will cause the value to change continuously.
- To change a value that has been set, press  (MEAS. button) in the screen where "↑ : <MEAS.>" is displayed. This will take you to the previous items, so change the value.
- Pressing the MEAS. button after the cursor has returned to the first item (ΔL^*) will exit from the setting screen and the cursor will locate on "ADJUST".

8 If illuminant 2 has been selected, the observer and illuminant conditions for illuminant 2 set in the measurement condition (COND1 to COND6) will be displayed. Turn to select it and press to switch to the screen that allows setting of box tolerances for illuminant 2. Set the desired box tolerances in the same way as in steps 6 and 7.

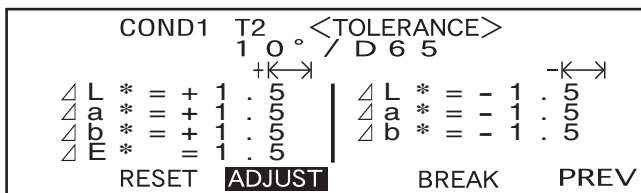

- Example when illuminant 2 is not selected.

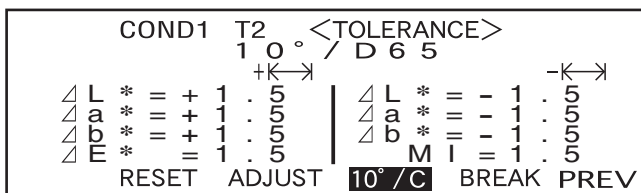

- Example when illuminant 2 is selected.
MI is displayed only when illuminant 2 has been selected.

9 Turn to select "PREV", and then press .

The <TARGET> screen will reappear.

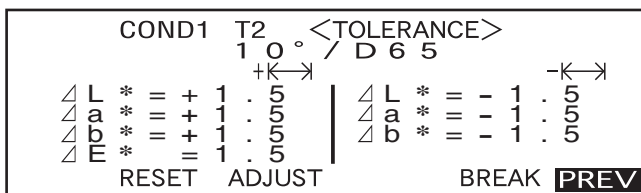

Elliptical Tolerance

Provided to judge whether the measured color difference is within the ellipse set for the target color.

[Memo]

- Elliptical tolerances must be set using the “L*a*b*” color space axis if “L*C*h” has been selected as the color space.
- After elliptical tolerances have been set, if the color space is switched to another (e.g. “WI”) that does not allow setting of elliptical tolerances, a message will appear informing you that the specified elliptical tolerances are no longer valid, and no pass/fail judgment based on the specified tolerances will be made.

[Note]

Target colors must be set before setting tolerances.

[Setting Procedure]

<COND*> screen



- 1 Turn  to select “TARGET”, then press .

```

                                <COND1>
CALIBRATION
TARGET      T*
FILE
DATA DELETE

                                BREAK PREV
  
```

- “T*” is the number of the color difference target data for the next measurement. If nothing is selected, “T--” appears.
- “T*” does not appear if “defined in COND.” mode is selected.

- 2 Turn  to select “◀▶”, then press .

“◀▶” will change to “▼▲”.

```

▲▼  COND1                      <TARGET>
      T 2                      31.05.04 10:10
                                1 0 ° / D 6 5

      L * = 2 9 . 3 5
      a * = - 0 . 8 9
      b * = - 1 1 . 5 5
DEL  ◀▶ TOLERANCE BREAK [P] PREV
  
```

- 3 Turn  to select the desired target color no. (T*), then press .

“▼▲” will return to “◀▶”.

```

▲▼  COND1                      <TARGET>
      T 2                      31.05.04 10:10
                                1 0 ° / D 6 5

      L * = 2 9 . 3 5
      a * = - 0 . 8 9
      b * = - 1 1 . 5 5
DEL  ▼▲ TOLERANCE BREAK [P] PREV
  
```

- Keeping  held down to left or right will cause the target color No. to change continuously.

4 Turn  to select “TOLERANCE”, then press .

A screen that allows selection of the tolerance type will appear.

If tolerances have already been set, they will be displayed, so skip to step 6.

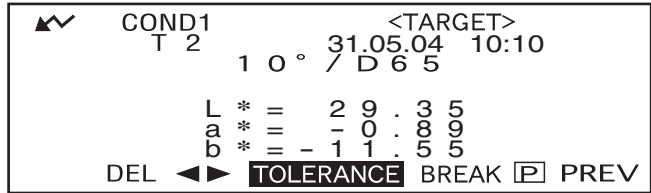

5 Turn  to select “ELLIPTICAL”, then press .



6 Turn  to select “ADJUST”, then press .

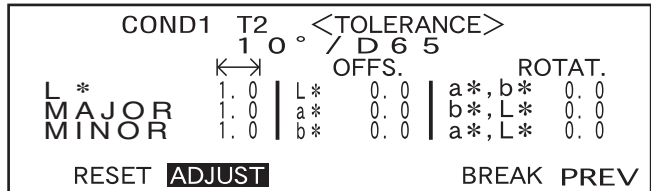

7 Select the value for an item to be set, starting from the top, then press .

The selected value will be set, and the cursor will move to the next value.

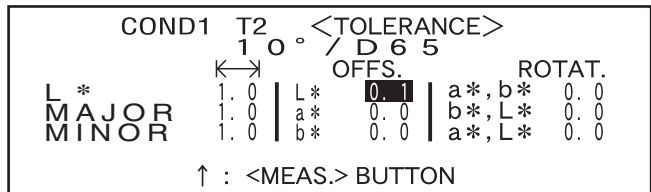

[Memo]

Keeping  held down will cause the cursor to move from one value to another continuously. The cursor will stop when it reaches “ADJUST”.





<Settings>

- **←→ (Tolerance range):** 0.1 to 20.0
The tolerance range for “MINOR” must be smaller than that for “MAJOR”.
- **OFFS.:** Below the specified +/- tolerances
- **ROTAT.:** 0.0 to 179.9

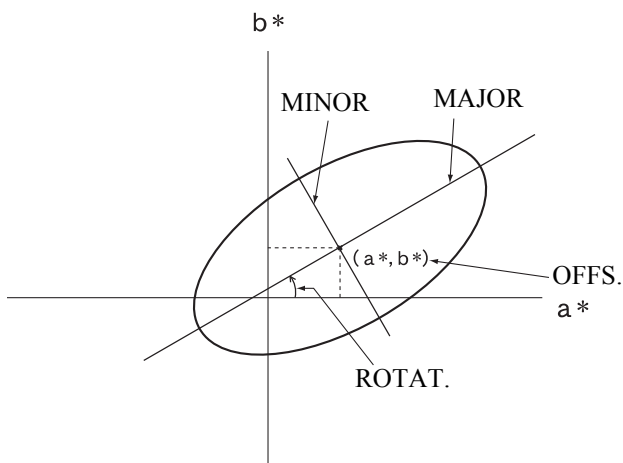

- Keeping  held down to left or right will cause the value to change continuously.
- “MAJOR” in the L*a*b* color space will be “a*” axis when “OFFS.” and “ROTAT.” on the “a*b*” plane are “0” (ZERO).
- To change a value that has been set, press  (MEAS. button) in the screen where “↑ : <MEAS.>” is displayed. This will take you to the previous items, so change the value.



8 If the measurement conditions (illuminant 2, observer, etc.) are displayed, turn  to select it and press  to switch to the screen that allows setting elliptical tolerances for illuminant 2. Set the desired elliptical tolerances in the same way as in steps 6 and 7.

COND1	T2	<TOLERANCE>			
	1 0 °	/ D 6 5			
	←→	OFFS.		ROTAT.	
L *	1. 0	L*	0. 0	a*, b*	0. 0
MAJOR	1. 0	a*	0. 0	b*, L*	0. 0
MINOR	1. 0	b*	0. 0	a*, L*	0. 0
RESET ADJUST			BREAK PREV		

- Example when Illuminant 2 is not selected.

9 Turn  to select “PREV”, then press .

The <TARGET> screen will reappear.

COND1	T2	<TOLERANCE>			
	1 0 °	/ D 6 5			
	←→	OFFS.		ROTAT.	
L *	1. 0	L*	0. 0	a*, b*	0. 0
MAJOR	1. 0	a*	0. 0	b*, L*	0. 0
MINOR	1. 0	b*	0. 0	a*, L*	0. 0
RESET ADJUST			BREAK PREV		

Memo

Use of the optional Color Data Software SpectraMagic NX (CM-S100w) or SpectraMagic (CM-S9w) Ver.3.6 allows you to set elliptical tolerances using CMC coefficients or to automatically set them using the target colors and some preset values.

Clearing Tolerances

To change the tolerance type, it is necessary to clear the currently set tolerances.

To clear the currently set tolerances, follow the procedure given below:

[Setting Procedure]

<TARGET> screen

1. Turn  to select "TOLERANCE", then press .

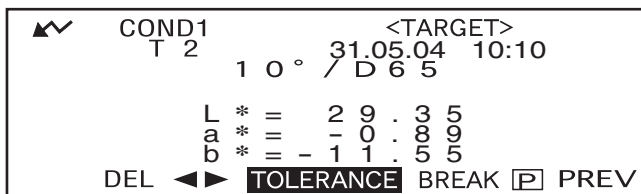

The currently set tolerances will be displayed.

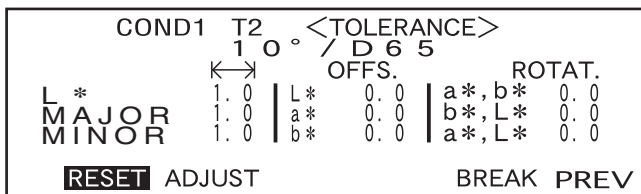

2. Turn  to select "RESET", then press .

A message confirming you whether to clear the tolerances will appear.



3. Turn  to select "OK" or "CANCEL", then press .

- If "OK" is selected, the currently set tolerances will be cleared, and a screen that allows selection of the tolerance type will appear. If a color space that does not allow setting of elliptical tolerances has been selected, a screen that allows setting of box tolerances will appear automatically. To make pass/fail judgment, it is necessary to set tolerances again.
- If "CANCEL" is selected, clearing of tolerances will be canceled and the previous screen will reappear.

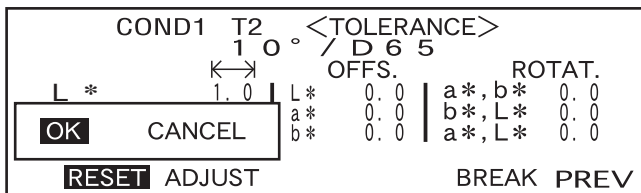

Chapter 3

Measurement

Measurement

To perform measurement, you need to switch from a screen in which “BREAK” is displayed to the measurement screen.

To perform measurement, follow the procedure given below:

Note

- Prior to start of measurement, be sure to perform white calibration. For details, refer to “White Calibration” (page E-40).
- To measure color difference, it is necessary to set target colors first and then select the one to be used for measurement.
- For accurate measurement, make sure to keep measurement conditions (ambient temperature etc.) constant.

[Operating Procedure]

- 1 Turn  to select “BREAK”, then press .



- Example for <COND1> screen.
- “T*” is the number of the color difference target data for the next measurement. If nothing is selected, “T---” appears.
- “T*” does not appear if “defined in COND.” mode is selected.

- 2 Place the specimen measuring port to the specimen.

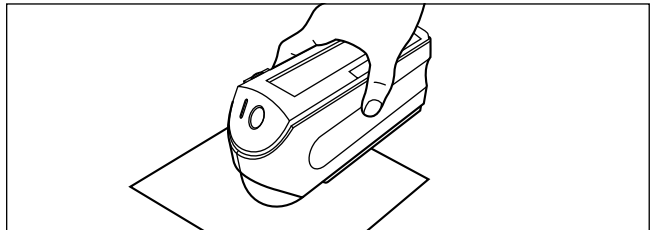

- 3 Make sure that  is displayed, then press  (MEAS. button).

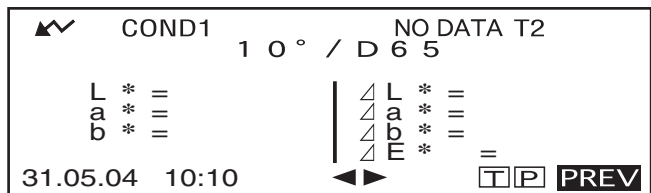

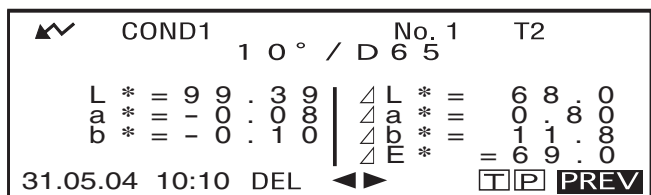

The lamp will flash, measurement will be taken, then the result will appear on the LCD.



- Example when “DIFF&ABS” is selected as the display mode.

Memo

- Measurement will no longer be possible once the total number of target color data and measured data reaches 1700 (and 700 in the “defined in COND.” mode). In this case, delete some target color data or measured data.
- If  does not appear due to the auto power save function, this may be due the fact that it can take time to start measurement after  is pressed.

Displaying the Measurement Results

At the end of measurement, the measurement results will be displayed on the LCD according to the specified measurement condition. Typical measurement result screens are shown hereafter. To change LCD's display contents, change them in the corresponding <COND*> screen. For details, refer to "Setting a Measurement Condition" (from page E-30).

Measured Data

The following screen appears if "DIFF&ABS" has been selected for "DISPLAY" mode.

Note

- Color difference will not be displayed if no target color has been selected.
- If the target mode is "linked to each data.", you will not be able to view the color difference for measurement data that uses the deleted color difference target data.

Memo

"#####" will be displayed if the color difference data has three or more decimal places.

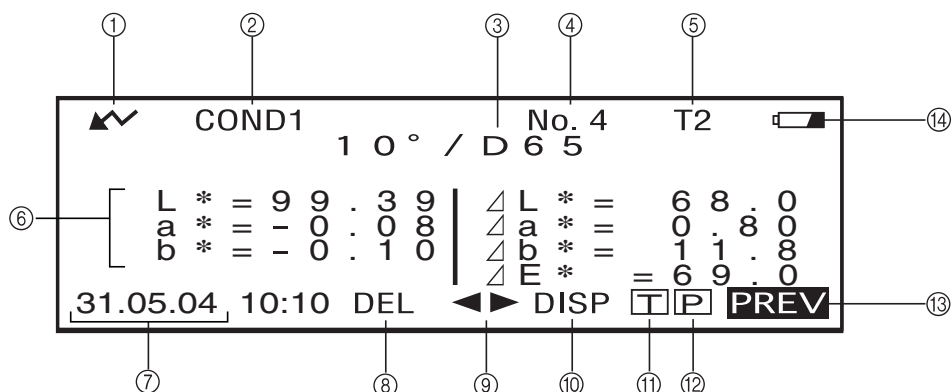



- ① Ready to measure.
- ② Currently selected <COND*> no.
- ③ Currently selected observer/illuminant
- ④ Currently selected measured data no.
- ⑤ Currently selected target color no.
- ⑥ Measured data
- ⑦ Measurement date and time. For the year, only the lower two digits are displayed.
- ⑧ Deletes the currently displayed measured data.
- ⑨ Displays other measured data.
- ⑩ Switches the screen page from one to another (when there are two pages or more).
- ⑪ Switches to the <TARGET> screen for the currently selected no. (T*).
- ⑫ Outputs the currently displayed measured data to the printer.
- ⑬ Returns to the <COND*> screen.
- ⑭ Appears if there is insufficient battery power when the instrument is powered by the battery. If appears, replace the batteries with new ones.

Pass/Fail Judgment

The following screen appears if “PASS/FAIL” has been selected for “DISPLAY” mode and tolerances have been set.

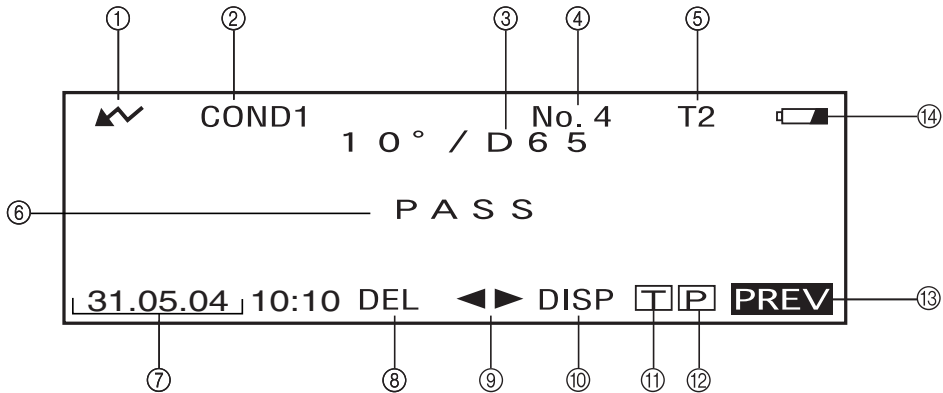
- When the result is “PASS”



- ① Ready to measure.
- ② Currently selected <COND*> no.
- ③ Currently selected observer/illuminant
- ④ Currently selected measured data no.
- ⑤ Currently selected target color no.
- ⑥ PASS/FAIL judgment result.
- ⑦ Measurement date and time. For the year, only the lower two digits are displayed.
- ⑧ Deletes the currently displayed measured data.
- ⑨ Displays other measured data.
- ⑩ Switches the screen page from one to another (when there are two pages or more).
- ⑪ Switches to the <TARGET> screen for the currently selected no. (T*).
- ⑫ Outputs the currently displayed measured data to the printer.
- ⑬ Returns to the <COND*> screen.
- ⑭ Appears if there is insufficient battery power when the instrument is powered by the battery. If  appears, replace the batteries with new ones.

- When the result is “FAIL”



Color Difference Graph

The following screen appears if “COLOR GRAPH” has been selected for “DISPLAY” mode. The $L^*a^*b^*$ color difference value and the assessment message will be displayed in this screen regardless of the color space selected for “COLOR SPACE” condition item. The data will be plotted in a color difference graph with the selected target color as the origin.

Note

- If no target color has been selected, no color difference will be displayed and the graph will be blank.
- If the target mode is “linked to each data.,” you will not be able to view the color difference for measurement data that uses the deleted color difference target data.

Memo

“#####” will be displayed if the color difference data has three or more decimal places.

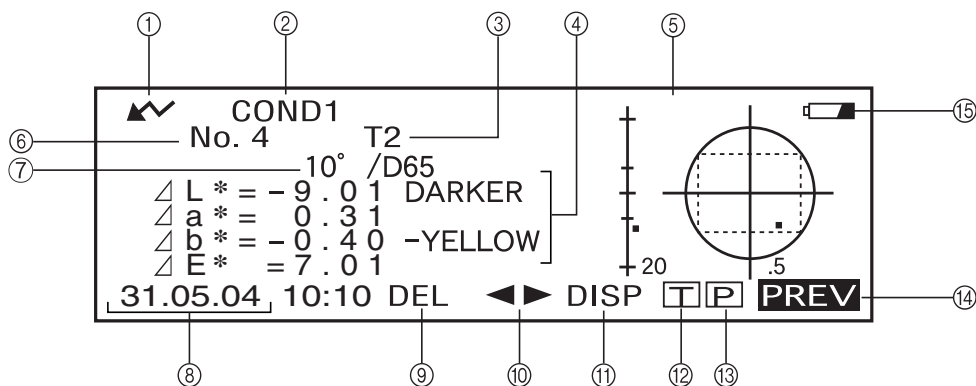

- ① Ready to measure.
- ② Currently selected <COND*> no.
- ③ Currently selected target color no.
- ④ Measured data.
- ⑤ Color difference graph
- ⑥ Currently selected measured data no.
- ⑦ Currently selected observer/illuminant
- ⑧ Measurement date and time. For the year, only the lower two digits are displayed.
- ⑨ Deletes the currently displayed measured data.
- ⑩ Displays other measured data.
- ⑪ Switches the screen page from one to another (when there are two pages or more).
- ⑫ Switches to the <TARGET> screen for the currently selected no. (T*).
- ⑬ Outputs the currently displayed measurement result to the printer.
- ⑭ Returns to the <COND*> screen.
- ⑮ Appears if there is insufficient battery power when the instrument is powered by the battery. If  appears, replace the batteries with new ones.

• **Color difference graph**

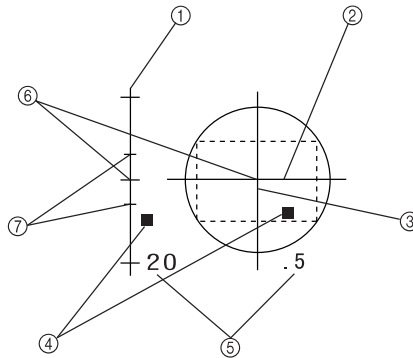

- ① ΔL^* axis (color difference graph)
- ② Δa^* axis (color difference graph)
- ③ Δb^* axis (color difference graph)
- ④ Measuring point
- ⑤ Scale for each axis
- ⑥ Specified box tolerances
- ⑦ Position of target color

Spectral Reflectance Graph

The following screen appears if “SPECT. GRAPH” has been selected for “DISPLAY” mode.

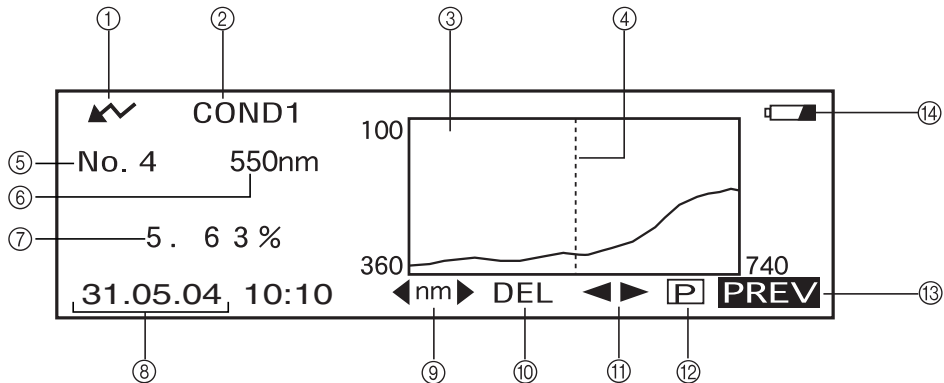

- ① Ready to measure.
- ② Currently selected <COND*> no.
- ③ Spectral reflectance graph
- ④ Position of the currently selected wavelength
- ⑤ Currently selected measured data no.
- ⑥ Currently selected wavelength
- ⑦ Spectral reflectance at the currently selected wavelength data
- ⑧ Measurement date and time. For the year, only the lower two digits are displayed.
Select the wavelength in the spectral reflectance graph.
- ⑨ Turn to select and press to switch to . The desired wavelength can be selected by turning .
- ⑩ Deletes the currently displayed measured data
- ⑪ Displays other measured data.
- ⑫ Outputs the currently displayed measurement result to the printer.
- ⑬ Returns to the <COND*> screen.
- ⑭ Appears if there is insufficient battery power when the instrument is powered by the battery. If appears, replace the batteries with new ones.

Assessments

The following screen appears if “ASSESSMENTS” has been selected for “DISPLAY” mode and tolerances have been set.

Memo

“#####” will be displayed if the color difference data has three or more decimal places.

• Displaying Assessment by Box Tolerance

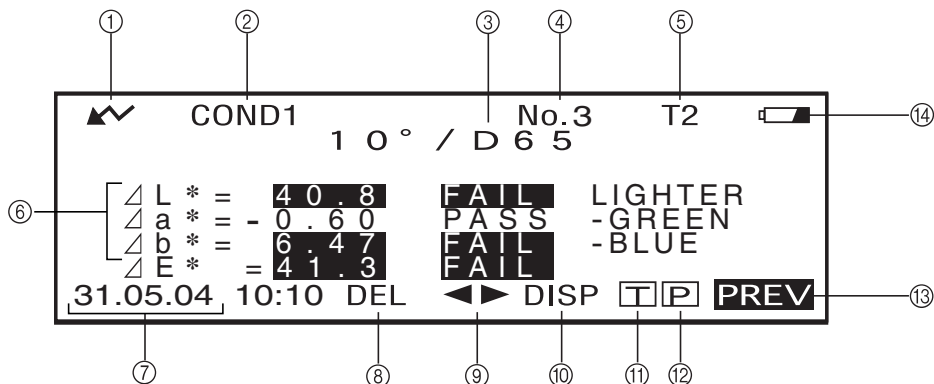



- ① Ready to measure.
- ② Currently selected <COND*> no.
- ③ Currently selected observer/illuminant
- ④ Currently selected measured data no.
- ⑤ Currently selected target color no.
- ⑥ Color Difference from the target, result of PASS/FAIL judgment and message indicating the deviation direction
- ⑦ Measurement date and time. For the year, only the lower two digits are displayed.
- ⑧ Deletes the currently displayed measured data
- ⑨ Displays other measured data.
- ⑩ Switches the screen page from one to another (when there are two pages or more).
- ⑪ Switches to the <TARGET> screen for the currently selected no. (T*).
- ⑫ Outputs the currently displayed measured data to the printer.
- ⑬ Returns to the <COND*> screen.
- ⑭ Appears if there is insufficient battery power when the instrument is powered by the battery. If  appears, replace the batteries with new ones.

Switching the Display Contents of the Measurement Results

In the measurement screen that appears at the end of measurement, the following data will be displayed according to the settings made in the <FILE> screen. The display contents can also be changed.

Memo

Selecting “DISP” by turning  in a measurement screen in which “DISP” is displayed and then pressing  will allow you to switch the display contents of the measurement results.

Settings in <FILE> Screen			Screen Switching	
Display Mode (P. E-38)	Color Space (P. E-39)	Other Conditions	Measurement Screen 1	Measurement Screen 2
DIFF&ABS (Color difference & absolute value)	L*a*b*, L*C*h, XYZ, Yxy etc.	Only illuminant 1 is set.	Color difference, absolute value	—
		Both illuminants 1 and 2 are set.	Metamerism index (MI)*	Color difference, absolute value
	WI, YI etc.		Color difference, absolute value	—
	Munsell, density		Absolute value only	—
PASS/FAIL	L*a*b*, L*C*h, XYZ, Yxy etc.	Only illuminant 1 is set.	PASS or FAIL	Metamerism index (MI), color difference & absolute value
		Both illuminants 1 and 2 are set.	PASS or FAIL	Metamerism index (MI), color difference & absolute value
	WI, YI etc.		PASS or FAIL	Color difference, absolute value
	Munsell, density		Absolute value only	—
COLOR GRAPH (Color difference graph)	L*a*b* only	Japanese only	Color difference graph, color difference, absolute value	Color difference, absolute value
			Color difference graph, color difference, deviation A	Color difference, absolute value
SPECT. GRAPH (Spectral graph)			Spectral graph, reflectance of selected wavelength	—
ASSESSMENT	L*a*b*, L*C*h only	Box tolerance	Color difference, deviation A, PASS or FAIL	Color difference, absolute value
		Elliptical tolerance	Color difference, deviation B, PASS or FAIL	Color difference, absolute value

Note

- *Metamerism index is displayed only if L*a*b* or L*C*h is selected as the color space.*
- *“Deviation A” indicates that the direction in relation to the target color is displayed, irrespective of whether the results are PASS or FAIL. “Deviation B” indicates that “PASS” is displayed when the result is PASS and the direction is displayed only when the result is FAIL.*
- *Items enclosed by are not displayed in English.*

Deleting Measured Data

There are two methods of deleting measured data. One is to delete the data items displayed on the LCD one by one. The other is to delete all the data items for the selected measurement condition (COND1 to COND6).



Deleting Data One by One

Data currently displayed on the LCD can be deleted.

This can be done in the measurement screen.



1. Turn  to select “◀▶”, and then press .

“◀▶” will change to “▼▲”.



	COND1	1 0° / D	No. 4	T2
			6 5	
L *	= 9 9 . 3 9	Δ	L *	= 6 8 . 0
a *	= - 0 . 0 8	Δ	a *	= 0 . 8 0
b *	= - 0 . 1 0	Δ	b *	= 1 1 . 8
		Δ	E *	= 6 9 . 0
31.05.04	10:10	DEL		DISP  PREV



2. Turn  to select the data to be deleted, and then press .

“▼▲” will return to “◀▶”.



	COND1	1 0° / D	No. 4	T2
			6 5	
L *	= 9 9 . 3 9	Δ	L *	= 6 8 . 0
a *	= - 0 . 0 8	Δ	a *	= 0 . 8 0
b *	= - 0 . 1 0	Δ	b *	= 1 1 . 8
		Δ	E *	= 6 9 . 0
31.05.04	10:10	DEL		DISP  PREV





- Keeping  held down to left or right will cause the preset data No. (No.*) to change continuously.

3. Turn  to select “DEL”, and then hold down  for more than one second.

	COND1	1 0° / D	No. 4	T2
			6 5	
L *	= 9 9 . 3 9	Δ	L *	= 6 8 . 0
a *	= - 0 . 0 8	Δ	a *	= 0 . 8 0
b *	= - 0 . 1 0	Δ	b *	= 1 1 . 8
		Δ	E *	= 6 9 . 0
31.05.04	10:10	DEL		DISP  PREV

A confirmation message will appear.

	COND1	1 0° / D	No. 4	T2
			6 5	
L *	= 9 9 . 3 9	Δ	L *	= 6 8 . 0
a *	= - 0 . 0 8	Δ	a *	= 0 . 8 0
b *	= - 0 . 1 0	Δ	b *	= 1 1 . 8
		Δ	E *	= 6 9 . 0
31.05.04	10:10	DEL		DISP  PREV

4. To delete the data, select “OK” with  and press . The selected data will be deleted, and the data below the deleted one will scroll up.
To cancel deletion, select “CANCEL” with  and press . Deletion of the data will be canceled, and the previous screen will reappear.

Deleting All Data At Once

All the data items for the selected measurement condition (COND1 to COND6) can be deleted at once.

Note

- Never turn OFF the instrument while global deletion is in progress.
- Should the instrument be turned OFF during global deletion, the measured data for all the measurement conditions (COND1 to COND6) as well as for all the tasks will be deleted.
However, measurement conditions (e.g. color space) and target color data will be retained.

This can be done in the <INITIAL> screen.

1. Turn  to select the measurement condition (COND*) of which all the measured data is to be deleted globally, then press .

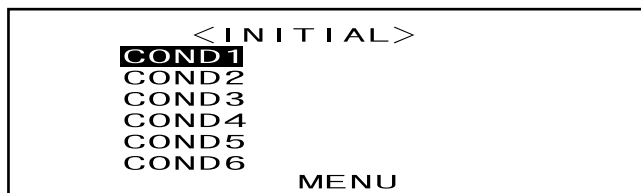

2. Turn  to select "DATA DELETE", then press .

A confirmation screen will appear.



- "T*" does not appear if "defined in COND." mode is selected.

3. Turn  to select "OK", then press .

All the measured data will be globally deleted.



During global deletion, the amount of deleted measured data will be displayed in a percentage.

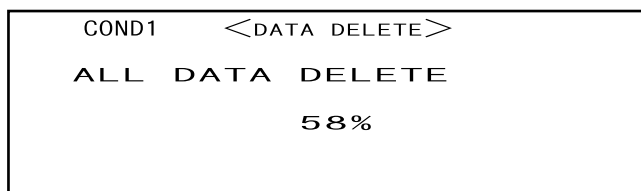

When data deletion is complete, the <COND*> screen will reappear.

Memo

To cancel deletion, select "CANCEL" and press . Global deletion will be canceled.



- "T*" does not appear if "defined in COND." mode is selected.

Abbreviations on LCD Display

To facilitate the user's understanding of various types of information displayed on the instrument's LCD, the following abbreviations are commonly used.

- For notation of values to be set in each setting screen (e.g. measurement conditions), refer to the description given in the corresponding operating procedure.

Screen/Item		Notation	Meaning
Screens in following Display mode • "DIFF&ABS" • "PASS/FAIL"	Color space, colorimetric data	CMC1	CMC1:1
		CMC2	CMC2:1
		$\Delta L4$	ΔL for CIE94
		$\Delta C4$	ΔC for CIE94
		$\Delta H4$	ΔH for CIE94
		$\Delta E94$	ΔE for CIE94
		ΔLc	ΔL for CMC1:1 or CMC2:1
		ΔCc	ΔC for CMC1:1 or CMC2:1
		ΔHc	ΔH for CMC1:1 or CMC2:1
		Tw	Tint value
		$\Delta E00$	ΔE when CIE00 is set

Measurement Results for “linked to each data.”

This instrument can set multiple target color data numbers and select one of those for displaying the results for the color difference. It can also easily switch the selected target color number using the navigation wheel. The “defined in COND.” target mode can use these functions to calculate multiple color differences for measurement data, and make pass/fail judgments based on this.

However, the pass/fail judgment is based on a standard color difference setting for the selected target color data number and the color difference. The differences between the target color data and the color difference is not always standard.

The other target mode supported by this instrument, “linked to each data.”, can store the target color data number with the selected measurement data and display the results using the associated target color data number. In addition to absolute values, it can also be used for general color differences.

This section describes how the results are affected when using “linked to each data.” target mode and the specified target color data has been changed or deleted. It also compares the difference to the results displayed for “defined in COND.” target mode.

When the Color Difference Target Data No. has Been Changed

When “T” is selected in the measurement results screen, the target color screen will be changed to the currently selected number to be used for next measurement. The navigation wheel can also be used in this screen to recall a target color number that has been stored in the instrument’s memory. If “BREAK” is selected in the target color data screen, you can revert to the originally selected target color number. For details, see “Switching between the Measured Data screen and the <TARGET> screen” on page E-44.

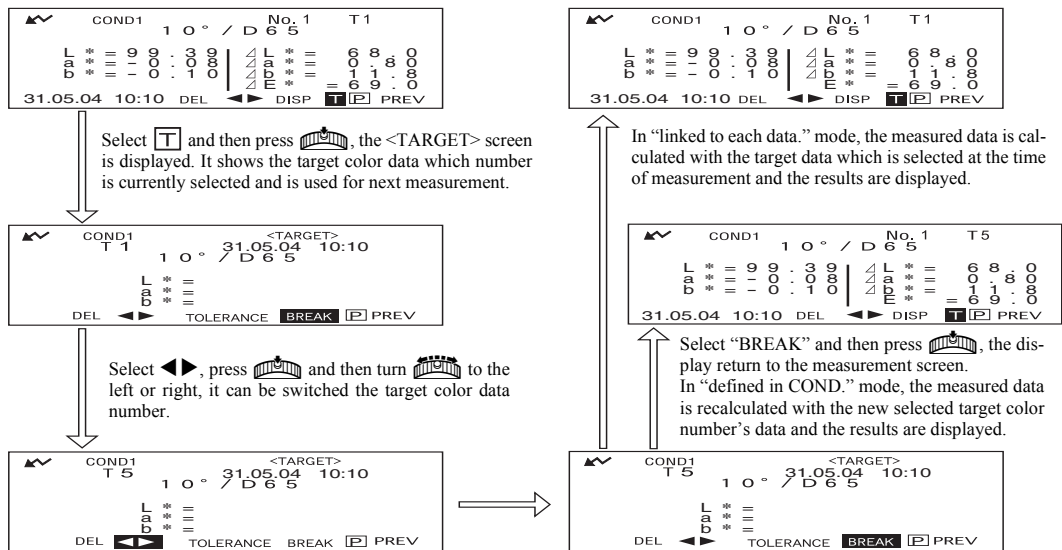

When the Target Color Data No. has Been Deleted

If the target color data for a number is deleted, the target color for data to which that number was associated is set to that of the next highest number. The target color number is reset to that of the number for which there is a target color data number.

With “linked to each data.” target-mode, the measured data is saved with target color number that was specified for it at the time of measurement. If the number for the target color that was set at the time of measurement is deleted, the link between the data and target color data number is cut when the number is deleted. The measurement data is saved with information that states that there is no target color for that data, “T---” is displayed for the target color, and “-----” for the color difference and pass/fail judgment. In addition, no points appear on the graph.

With “defined in COND.” the color difference and pass/fail judgments for the reset target color data and its data are recalculated based on the associated color difference.

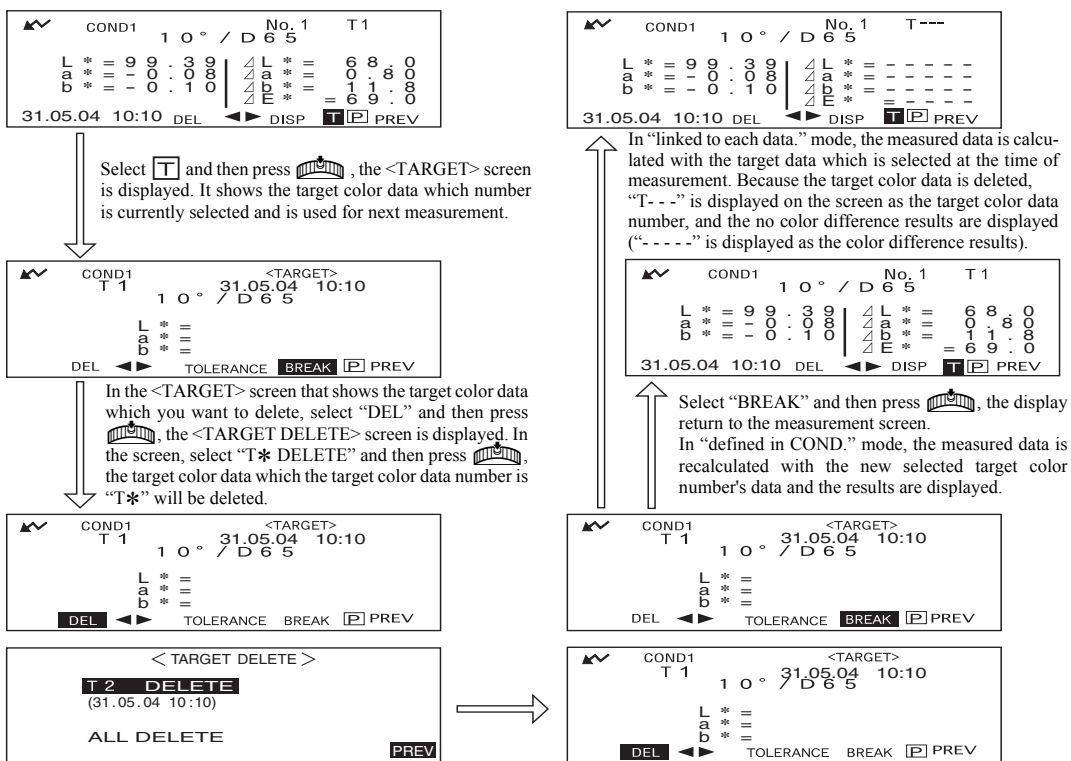

If a number for target color data is deleted, the target color is set to the next target color, but set as the target color of the deleted number.

* In the example above, target color T2 has been set to number T1.

Chapter 4

Other Functions



Measuring the Average

When taking measurements or setting target colors, more accurate data can be obtained if the averaging function is used.

The following two averaging functions are available.

- **Manual Averaging:** When the color of the specimen is not uniform, measurements are performed at different positions on the specimen and then the average of the measured reflectance data is calculated. This gives the average data of the entire specimen.
- **Auto Averaging:** Specified number of measurement are repeated at the same position on the specimen and then the average of the measured spectral reflectance data is calculated. This will improve the accuracy of the measured data.

These two functions can be used in combination. In this case, it is necessary to make settings for both auto and manual averaging. For details, refer to “Setting a Measurement Condition” (from page E-30).

Note

For average measurement, the average of the measured spectral reflectance data is calculated first, then colorimetric data is calculated based on that calculated average. Thus, the result may not match the average of colorimetric data.

Manual Averaging

This method is used when the color of the specimen is not uniform. Measurements are performed at different positions on the specimen and then the average of the measured reflectance data is calculated, to obtain the average data of the entire specimen.

Set the number of measurements to be performed and the standard deviation, and then start measurement.

Note

Before starting manual averaging, make sure that the number of measurements to be performed and standard deviation are set. For details, refer to “Setting a Measurement Condition” (from page E-30).

[Setting Procedure]

This operation can be started from a screen in which “BREAK” is displayed.

1 Make sure that “BREAK” is highlighted, then press .

Turn  to select “BREAK”, if it is not highlighted.

COND1	<FILE>	2/2
COLOR SPACE	L*a*b*, ΔE*	
MANUAL AVG.		
TIMES	3	
DEVIATION	0 . 2 0	
AUTO AVG.	3	
DELAY TIME	0 . 0 s	
	SEL ▶ 1/2	BREAK PREV

- Example when “COND1” is selected.

2 Place the specimen measuring port to the specimen to be measured, and then press (MEAS. button).

If 2 is set for “MANUAL AVG. TIMES” or if 3 or a higher value is set and the standard deviation is not below the specified one, place the specimen measuring port to the next place and then press  (MEAS. button).

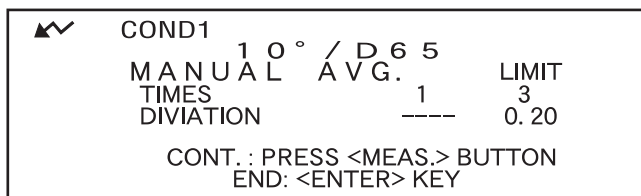
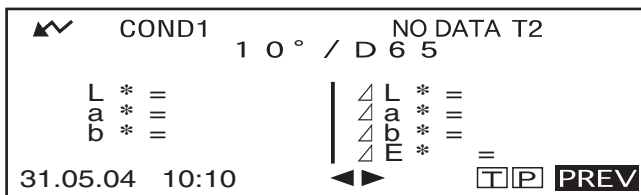

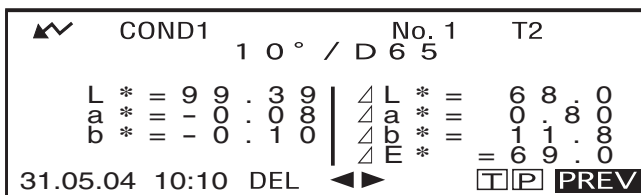

- The number of completed measurements including the one currently in progress and standard deviation will be displayed during measurement.

When the specified number of measurements has been completed or the standard deviation drops below the specified one, the averaging result will be displayed on the LCD.



Memo

- To exit manual averaging and display the results before the specified number of measurements is completed or before the specified standard deviation is reached, press .
- If  does not appear due to the auto power save function, this may be due the fact that it can take time to start measurement after  is pressed.

Auto Averaging

Measurement is repeated the specified number of times in the same position on the specimen and then the average of the measured reflectance data is calculated. This will improve the accuracy of the measured data.

Set the number of measurements to be performed and the standard deviation, and then start measurement.

Note

Before starting auto averaging, make sure that the number of measurements to be performed is set. For details, refer to "Setting a Measurement Condition" (from page E-30).

[Setting Procedure]

This operation must be started from a screen in which "BREAK" is displayed.

1 Make sure that "BREAK" is highlighted, then press .

Turn  to select "BREAK", if it is not highlighted.

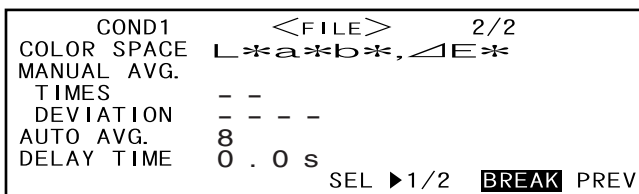

• Example when "COND1" is selected

2 Place the specimen measuring port to the specimen, and then press (MEAS. button).

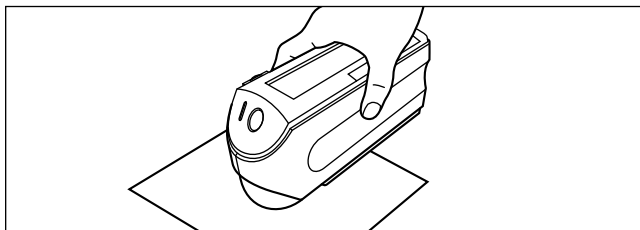



• Take care to keep the instrument still during measurement.

The number of lamp flashing will be highlighted during auto averaging.



When the specified number of measurements has been completed, the averaging result will be displayed on the LCD.

Memo

If  does not appear due to the auto power save function, this may be due the fact that it can take time to start measurement after  is pressed.

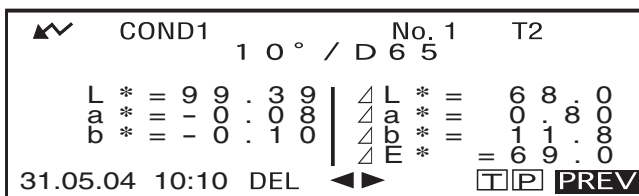

Pass/Fail Judgment for Color Difference

This instrument allows you to set tolerances for the measured color difference, to make pass/fail judgment.

Two kinds of pass/fail judgment methods are available. One is based on the specified box tolerances, and the other is based on the specified elliptical tolerances.

In “linked to each data.” mode, the number of the target color data selected at the time of measurement or the measured data are passed/failed based on the tolerances.

If the target color data has been deleted, the color difference displayed for that color target and based on the tolerances for the color target cannot be performed. In addition, if other target color data is selected, recalculations and pass/fail judgments cannot take place.

Pass/Fail Judgment Based on Box Tolerances

If the measured color difference is outside the specified tolerances, it will be highlighted to indicate that the pass/fail judgment result is FAIL. Both + and - tolerances can be set for each target color.

To perform pass/fail judgment based on the specified box tolerances, follow the procedure given below:

Note

To use this function, make sure that the target color to be used is set.



[Setting Procedure]

<COND*> screen

- 1 Turn  to select “TARGET”, then press .



- “T*” does not appear if “defined in COND.” mode is selected.

- 2 Turn  to select “◀▶”, then press .

“◀▶” will change to “▼▲”.

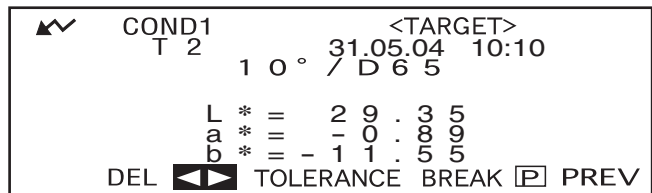

- 3 Turn  to select the desired target color no. (T*), then press .

“▼▲” will return to “◀▶”.

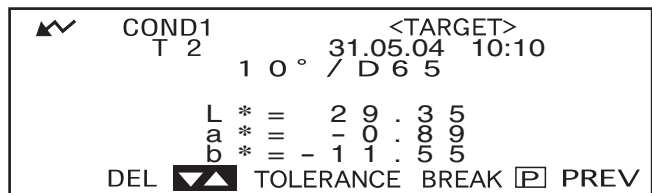

- Keeping  held down to left or right will cause the target color No. to change continuously.

4 Turn  to select “TOLERANCE”, then press .

The currently set tolerances will be displayed.

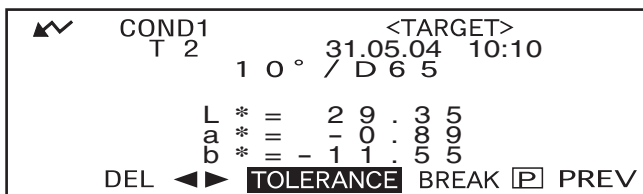

5 If they are satisfactory, turn  to select “BREAK”, then press .

The measurement screen will appear.

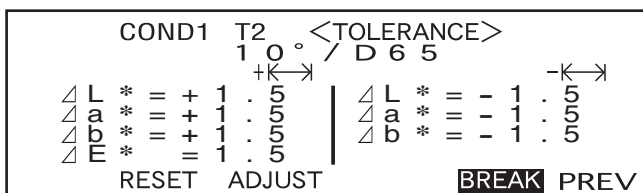

6 Place the specimen measuring port to the specimen, and then press  (MEAS. button).

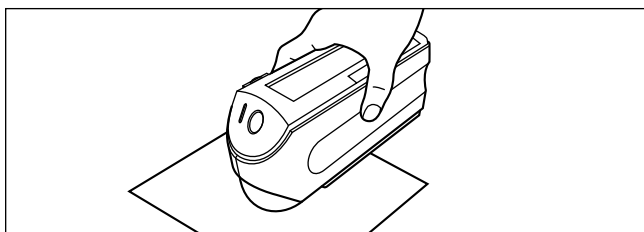

<If “DIFF&ABS” has been selected as the display mode>

Values for the items that have failed will be highlighted.

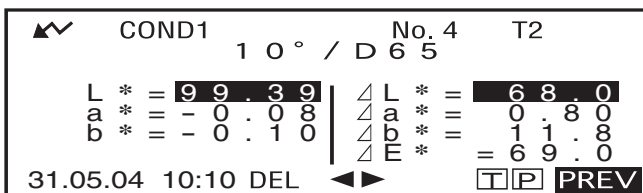

- “#####” will be displayed if the color difference data has three or more decimal places.

<If “PASS/FAIL” has been selected as the display mode>

“FAIL” will be displayed and highlighted if any of the items has failed, and “PASS” will be displayed if all the items have passed.





- Here the judgment result is “PASS”, and the results are displayed as shown above according to the conditions when the data was measured.



- Here the judgment result is “FAIL”, and the results are displayed as shown above according to the conditions when the data was measured.

[Memo]

- If “PASS/FAIL” has been selected as the display mode, “PASS” will be displayed only when all the items have passed.
- If “DIFF/ABS” has been selected as the display mode, the values for the items which have failed will be highlighted
- If a color difference has not been set, when the target mode is “linked to each data.”, and the target color data number set at the time of measurement is deleted, “----” appears instead of “PASS/FAIL”.
- If  does not appear due to the auto power save function, this may be due the fact that it can take time to start measurement after  is pressed.

Pass/Fail Judgment Based on Elliptical Tolerances

This function is used to judge whether the measured color difference is within the elliptical tolerances specified for the target color.

To perform pass/fail judgment based on the specified elliptical tolerances, follow the procedure given below:

[Note]

- *To use this function, make sure that elliptical tolerances are set.*
- *“PASS” or “FAIL” is displayed only if “PASS/FAIL” has been selected as the display mode.*

[Setting Procedure]

<COND*> screen

- 1** Turn  to select “TARGET”, then press .



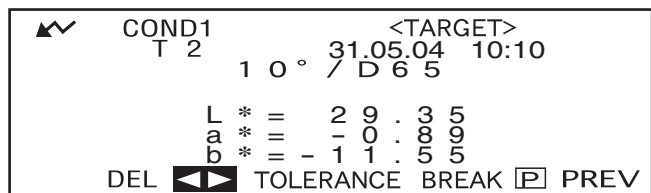

- “T*” does not appear if “defined in COND.” mode is selected.

- 2** Turn  to select “◀▶”, then press .
- “◀▶” will change to “▼▲”.

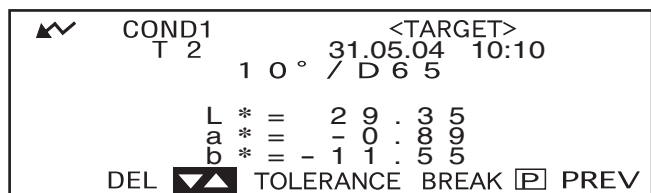

- 3** Turn  to select the desired target color no. (T*), then press .
- “▼▲” will return to “◀▶”.



- Keeping  held down to left or right will cause the target color No. to change continuously.

4 Turn  to select “TOLERANCE”, then press .

The currently set tolerances will be displayed.

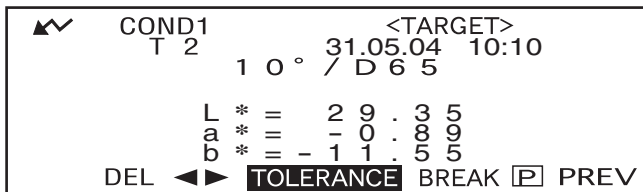

5 If they are satisfactory, turn  to select “BREAK”, then press .

The measurement screen will appear.

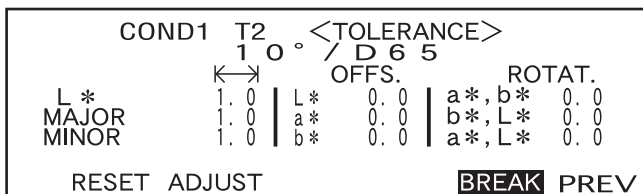

6 Place the specimen measuring port to the specimen, and then press  (MEAS. button).

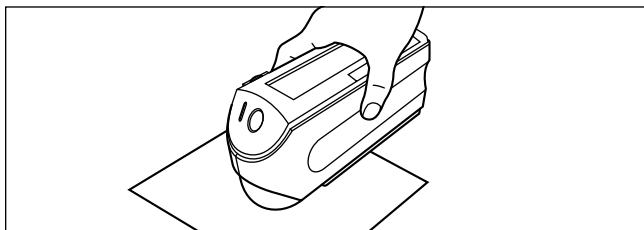

If “PASS/FAIL” has been selected as the display mode, a judgment will be made to check whether the measurement result is within the specified ellipse, and “PASS” or “FAIL” will be displayed accordingly.





• Example when the result is “PASS”.



• Example when the result is “FAIL”.

Memo

- If “PASS/FAIL” has been selected as the display mode, “PASS” will be displayed only when the color difference between the measured value and the target color is within each specified elliptical tolerance (up to four tolerances).
- If “DIFF/ABS” has been selected as the display mode, the measured results will not be highlighted even if they are “FAIL”.
- If a color difference has not been set, when the target mode is “linked to each data.”, and the target color data number set at the time of measurement is deleted, “----” appears instead of “PASS/FAIL”.
- If  does not appear due to the auto power save function, this may be due the fact that it can take time to start measurement after  is pressed.

Connecting to an External Device

Connecting a PC or printer to the external output terminal on the instrument allows the transfer of data between the instrument and PC or printing of the measurement results.

Connecting a Personal Computer

Connecting a PC (PC-AT compatible) to the instrument with the supplied cable will allow uploading the data stored in the instrument's memory to the PC or downloading data from the PC to the instrument.

When connecting the supplied USB-serial converter cable to the PC for the first time, it is necessary to install the dedicated USB driver to ensure that the cable is recognized correctly. The USB driver is on the CD-ROM included with the instrument. Before installing the driver, carefully read the installation guide on the CD-ROM. Note that the order in which the driver and the cable are installed differs according to the operating system.

The above USB driver can also be downloaded from the KONICA MINOLTA website via the URL below.
<http://www.konicaminolta.com/instruments/download/software/color/index.html>

(The above URL is subject to change without notice.)

When connecting this instrument to the PC, use of the optional Color Data Software SpectraMagic NX (CM-S100w) is recommended.

Memo

When the instrument is connected to the PC, make sure that the instrument is set in remote mode. Remote mode allows the following functions:

1. Outputting measured data and target color data to the PC
2. Downloading target data from the PC

For details, refer to “Switching to Remote Mode” (page E-78).

Note

- *Ensure all connectors are oriented correctly and connected securely.*
- *When disconnecting the cable, be sure to grip the plug or connector and pull it. Do not pull on or forcibly bend the cable.*
- *Do not touch the connector terminals with your hand. Doing so may cause them to get dirty or apply excessive force to them.*
- *Make sure that the cable has a sufficient length. Tensioning the cable may cause connection failure or wire breakage.*

When using the optional RS-232C cable

- *When connecting, securing the connector with a screw will ensure that it is not inadvertently disconnected.*
- *Before connecting, make sure that the power to both the instrument and PC is turned OFF.*

SIP/SOP Connections

- Accessories equipment connected the analog and digital interfaces must be certified to the respective IEC standards (i.e. IEC 950 for data processing equipment).
- Furthermore all configurations shall comply with the system standard IEC 10101-1. Everybody who connects additional equipment to the signal input part or signal output part configures a electrical equipment for measurement system, and is therefore, responsible that the system complies with the requirements of the system standard (IEC 10101-1. If in doubt, consult the technical services department or your local representative).

Switching to Remote Mode

To transfer data between the instrument and the PC, the instrument must be switched to remote mode. To switch to remote mode, follow the procedure given below.

[Setting Procedure]

Make sure that power to the instrument is turned OFF.

1. Connect the instrument to the PC with the accessory cable.

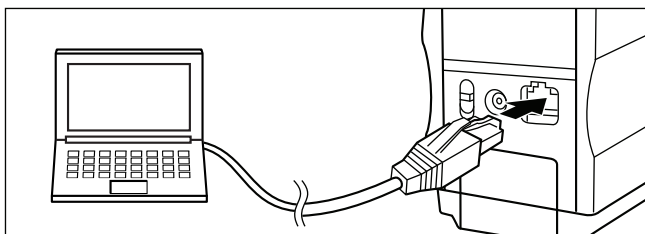

2. Turn the power ON.

- When the power is turned ON for the first time, the <INITIAL> screen will appear.
- Normally, the screen displayed just before the power was turned OFF will appear, so turn the navigation wheel to display the <INITIAL> screen.

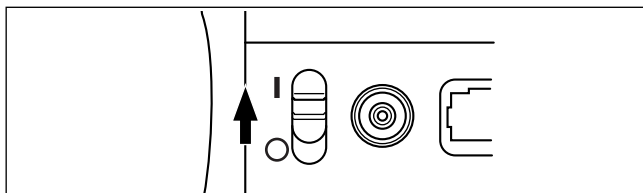

3. Turn to select "MENU", then press .



The <MENU> screen will appear.

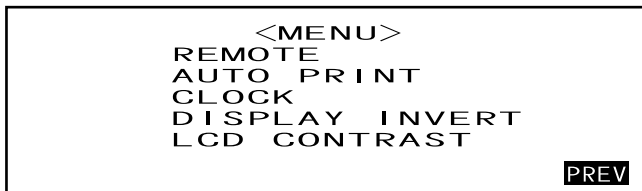

4. Turn  to select “REMOTE”, then press .

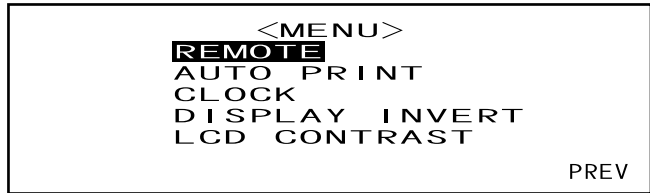

The <REMOTE> screen will appear.

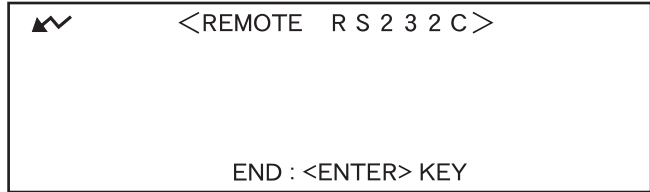

Memo

To return to the <MENU> screen, press .

Outputting to a Printer

Connecting the instrument to a printer with a printer cable allows printing the measured data or the color difference target data stored in the instrument's memory. Two printing methods are available. One is to print automatically each time measurement is taken (this is called "Auto Print"; measured data only), and the other is to print the currently displayed measured data, pass/fail results and color difference target data.

Memo

If "SPECT.GRAPH" is selected as the display mode, the spectral reflectance data of displayed data in each screen; the measured data in the measured data screen or the color difference target data in the <TARGET> screen, will be printed. If "COLOR GRAPH" is selected, the color difference and absolute data will be printed. If "PASS/FAIL" is selected, either "PASS" (or "FAIL") or the color difference and absolute data will be printed.

INote

- *When connecting the connectors, make sure that they are correctly oriented and fastened securely with screws.*
- *Before connecting, make sure that the power to both the instrument and printer is turned OFF.*
- *When disconnecting the cable, be sure to grip the plug or connector and pull it. Do not pull on or forcibly bend the cable.*
- *Do not touch the connector terminals with your hands, allow them to get dirty or apply excessive force to them.*
- *Make sure that the cable has a sufficient amount of slack. Pulling the cable taut may cause connection failure or wire breakage.*
- *The instrument and printer must be connected using a printer cable that is wired as shown in "Printer Cable Wiring Diagram" (page E-81). It is recommended that you use the optional printer cable (CR-A75, sold separately).*

Communication Parameters

Item	Setting
Baud rate	9600 bps
Character bits	8 bits
Parity	None
Stop bits	1 bit
Flow control	RTS/CTS

Applicable Printers: DPU-S245 *serial connection/metric screw type (Seiko Instruments Inc.)

In addition to the above printer, printers that meet the following specifications can be used.

Item	Specifications
Number of print lines	27 or more lines, Data input: RS-232C
Data control	BUSY
Baud rate	9600
Character bits	8 bits
Parity	None
Stop bits	1 bit
Basic function	CR (0DH) carriage return

Printer Cable Wiring Diagram

- For D-sub, 9pin

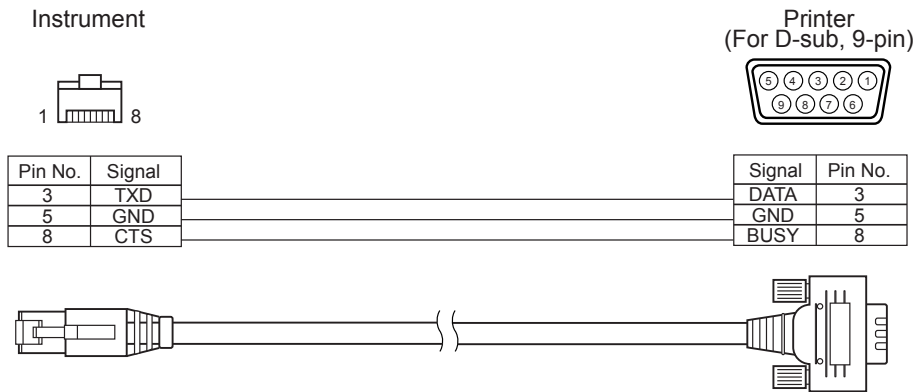

- For D-sub, 25pin

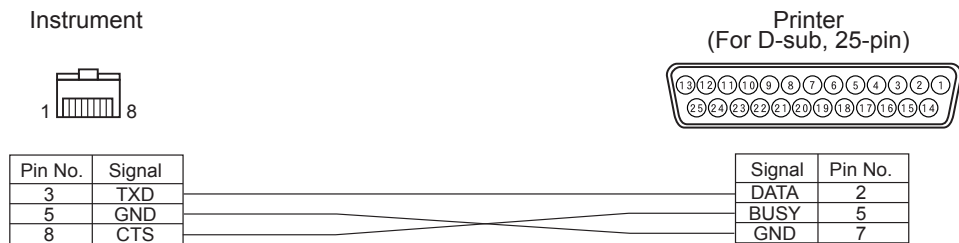

Auto Print

If Auto Print has been setup beforehand, the measurement data can be printed as each measurement is made.

Note

The instrument and printer must be connected using a printer cable that is wired as shown in “Printer Cable Wiring Diagram” (page E-81).

[Procedure]

Make sure that power to the instrument is turned OFF.

1. Connect the instrument to the printer with a printer cable.

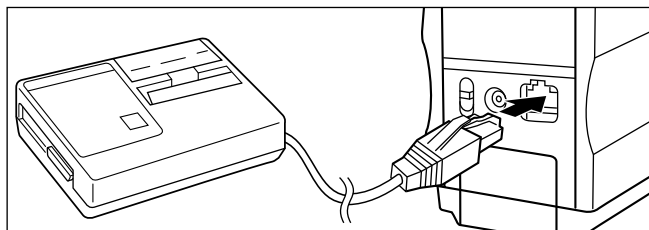

2. Turn the power ON.

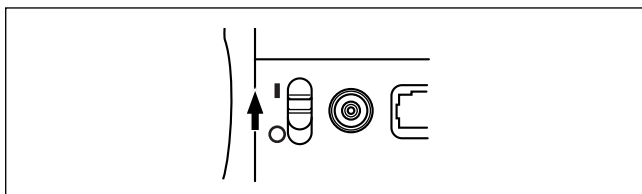



3. Turn  to select "MENU", then press .

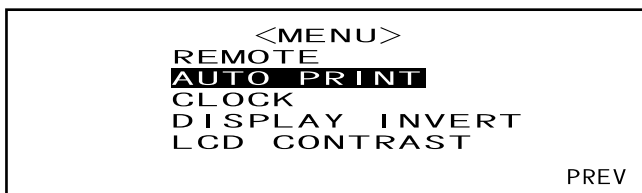

4. Turn  to select "AUTO PRINT", then press .



5. Turn  to select "ON", then press .

Measured data will be printed automatically each time measurement is taken.



Printing Measured Data

Memo

To print measured data, make sure that the instrument is connected to the printer with a printer cable.

Note

- The instrument and printer must be connected using a printer cable that is wired as shown in "Printer Cable Wiring Diagram" (page E-81).
- Before connecting, make sure that the power to both the instrument and printer is turned OFF.

[Procedure]

This operation must be started from a screen in which measured data is displayed.

1. Turn  to select “◀▶”, then press .

“◀▶” will change to “▼▲”.



▲▼	COND1	10° / D65	No. 4	T2
L * = 99.39	Δ	L * = 68.0		
a * = -0.08	Δ	a * = 0.80		
b * = -0.10	Δ	b * = 1.18		
	Δ	E * = 69.0		
31.05.04 10:10 DEL	◀▶	DISP	T P	PREV

2. Turn  to select the measured data to be printed, then press .

“▼▲” will return to “◀▶”.

▲▼	COND1	10° / D65	No. 4	T2
L * = 99.39	Δ	L * = 68.0		
a * = -0.08	Δ	a * = 0.80		
b * = -0.10	Δ	b * = 1.18		
	Δ	E * = 69.0		
31.05.04 10:10 DEL	▼▲	DISP	T P	PREV

- Keeping  held down to left or right will cause the measured data No. (No.*) to change continuously.

3. Turn  to select “P”, then press .

▲▼	COND1	10° / D65	No. 4	T2
L * = 99.39	Δ	L * = 68.0		
a * = -0.08	Δ	a * = 0.80		
b * = -0.10	Δ	b * = 1.18		
	Δ	E * = 69.0		
31.05.04 10:10 DEL	◀▶	DISP	T P	PREV

Memo/

- If “COLOR GRAPH” has been selected as the display mode, only numeric data will be printed.
- If “PASS/FAIL” has been selected as the display mode, either pass/fail judgment results or color difference and absolute data will be printed.
- If “SPECT.GRAPH” has been selected as the display mode, spectral reflectance data will be printed.

• Print Example 1

Display mode: “ABS. & DIFF.”

	No. 4	T2
	10° / D65	
L* = 99.39	dL* = 70.1	
a* = -0.08	da* = 0.81	
b* = -0.10	db* = 11.4	
	dE* = 71.0	
31.05.04 10:10		

• **Print Example 2**

Display mode: "SPECT.GRAPH"

No. 4			
360nm	94.53	560nm	98.42
370nm	96.31	570nm	98.37
380nm	97.15	580nm	98.39
390nm	97.83	590nm	98.30
400nm	98.47	600nm	98.37
410nm	98.59	610nm	98.33
420nm	98.70	620nm	98.19
430nm	98.70	630nm	98.34
440nm	98.58	640nm	98.20
450nm	98.50	650nm	98.20
460nm	98.65	660nm	98.23
470nm	98.54	670nm	98.14
480nm	98.61	680nm	98.17
490nm	98.52	690nm	98.20
500nm	98.58	700nm	98.27
510nm	98.58	710nm	98.13
520nm	98.50	720nm	98.11
530nm	98.55	730nm	98.14
540nm	98.48	740nm	98.08
550nm	98.45		
31.05.04	10:10		

• **Print Example 3**

Display mode: "COLOR GRAPH"

No. 4 T2			
10°/D65			
L* =	99.39	L* =	97.23
a* =	-0.08	a* =	-0.06
b* =	-0.10	b* =	0.06
31.05.04	10:10		

Printing Color Difference Target

Memo

To print color difference target data, make sure that the instrument is connected to the printer with a printer cable.

Note

- The instrument and printer must be connected using a printer cable that is wired as shown in “Printer Cable Wiring Diagram” (page E-81).
- Before connecting, make sure that the power to both the instrument and printer is turned OFF.



[Procedure]

This operation must be started from the <TARGET> screen.

1. Turn  to select “◀▶”, then press .

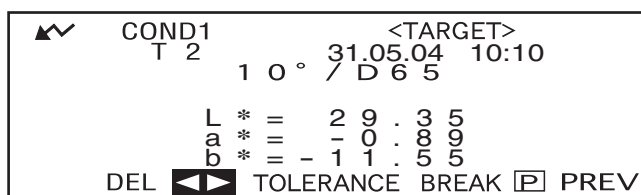
“◀▶” will change to “▼▲”.



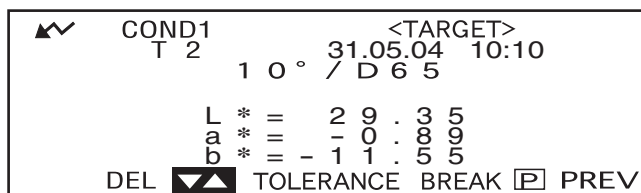

2. Turn  to select the color difference target data to be printed, then press .

“▼▲” will return to “◀▶”.



- Keeping  held down to left or right will cause the color difference target data No. (T*) to change continuously.

3. Turn  to select “[P]”, then press .

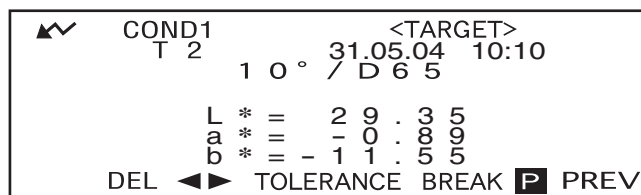

Memo

- If “SPECT.GRAPH” has been selected as the display mode, spectral reflectance data will be printed.
- If a mode other than “SPECT.GRAPH” has been selected as the display mode, only colorimetric value data will be printed.

Chapter 5

Troubleshooting



Error Messages

The following messages may appear while you are using the instrument. If such messages appear, take the necessary actions shown in the table below. If the trouble does not go away in spite of taking action, contact a KONICA MINOLTA-authorized service facility.

Memo



Messages that may be displayed on the LCD are given in the table below. For communication error check codes, refer to the separate document.

Message	Corrective Action	Symptom/Possible Cause	Corrective Action
OK02 LOW ILLUMINATION		Amount of light from the xenon lamp has dropped to 65% of its initial level. <ul style="list-style-type: none"> • Deterioration of xenon lamp • Dirt on the inside of the measuring aperture 	Clean the inside of the measuring aperture as explained in "Cleaning Each Part" (page E-14). If the problem still remains, contact a KONICA MINOLTA-authorized service facility.
OK10 MAKE WHITE CALIBRATION !		The reliability of the white calibration data has dropped because a certain period of time has passed since the last white calibration.	Performing white calibration is recommended.
ER01 MEMORY FULL		The instrument has a total of 1700 measurement and color difference target data stored. (700 in the "defined in COND." mode.).	Delete some data for securing necessary memory space. The memory of this instrument can store up to 1700 pieces of data in total, (700 in the "defined in COND." mode). This amount includes the sample data and color difference target data.
ER02 LOW BATTERY		(When the instrument is powered by batteries) <ul style="list-style-type: none"> • Battery voltage drop 	Replace the batteries with new ones.
ER05 ERROR IN FLASHING		Xenon lamp does not flash properly. <ul style="list-style-type: none"> • Xenon lamp has blown. • Faulty flash circuit • Faulty sensor 	Contact a KONICA MINOLTA-authorized service facility.
ER07 ZERO CALIBRATION INCOMPLETED		Zero calibration has not been performed.	Perform zero calibration.
ER11 FAILED IN CALIBRATION		Zero calibration or white calibration has not been performed correctly.	For zero calibration, the specimen measuring port must be directed into the air. For white calibration, the White Calibration Plate must be used.
ER13 ERROR IN A/D		Failed during A/D conversion. <ul style="list-style-type: none"> • Faulty A/D converter • Break down of circuits relating to the A/D converter 	Turn the power OFF, and then turn it ON again. If this message keeps appearing, contact a KONICA MINOLTA-authorized service facility.

Message	Corrective Action	Symptom/Possible Cause	Corrective Action
ER17 INCORRECT CLOCK OPERATION		Clock IC is not working correctly. • Clock IF's power voltage drop or breakdown of circuits relating to the clock IC.	Contact a KONICA MINOLTA-authorized service facility.
ER24 WHITE CALIBRATION IN-COMPLETED		White calibration has not been performed.	White calibration must be performed each time the instrument is turned ON. White calibration must also be performed when the measurement area or specular component setting is changed.
ER27 ERROR IN CHARGING		Charging for flashing of Xenon lamp can't be completed • Breakdown of charging circuit • Battery voltage drop	Contact a KONICA MINOLTA-authorized service facility.
ER30 NO DATA IN MEMORY		Data has been lost since the memory's backup battery is exhausted.	Turn the power ON to charge the memory's backup battery. The backup batteries can be fully charged in 25 hours when the power of this instrument is turned ON. After the batteries are fully charged, data backup can be stored for approximate 4.5 months.

Troubleshooting

If an abnormality has occurred with the instrument, take necessary actions as given in the table below. If the instrument still does not work properly, turn the power OFF, and then turn it ON again. If the symptom remains, contact a KONICA MINOLTA-authorized service facility.

Symptom	Check Point	Action
LCD is blank.	Are batteries inserted? Is the AC adapter connected?	Insert the batteries. Connect the AC adapter.
	Is the LCD contrast appropriate?	Adjust the LCD contrast. (page E-28)
	Isn't  displayed? Or isn't the batteries extremely low?	Replace the batteries with new ones.
“  ” does not appear.	Are batteries inserted? Is the AC adapter connected?	Insert the batteries. Connect the AC adapter.
	Isn't  displayed? Or isn't the batteries extremely low?	Replace the batteries with new ones.
MEAS. button is not effective.	Is measurement still in progress?	Wait until measurement is complete, and then press the button.
	Is a measurement screen displayed?	MEAS. button must be pressed while a measurement screen is displayed.
Abnormal measurement result	Is the instrument directed perpendicular to the specimen?	Make sure that the instrument is directed perpendicular to the specimen, to prevent leakage of light.
	Is the White Calibration Plate correct?	Use the correct White Calibration Plate to perform white calibration. (page E-40)
	Was white calibration performed correctly?	
	Was zero calibration performed correctly?	Direct the specimen measuring port into the air or use the optional Zero Calibration Box and perform zero calibration. (page E-38)
Measurement results fluctuate.	Is instrument kept stationary during measurement?	Do not allow the instrument to move during measurement.
Not possible to input data to the computer. No commands from computer are accepted. Commands cannot be accepted correctly.	Is the cable connected to the PC connected correctly?	Connect the instrument's external output terminal correctly to the computer's connector with the correct accessory cable for the instrument.
	Is the cable connected to the PC the instrument's accessory cable?	
	Do communications settings on the instrument match those on the computer?	Set the same communications settings as those on the instrument to the computer.
Not possible to print.	Is the printer cable connected correctly?	The printer must be connected to the external output terminal on the instrument using a printer cable that is wired as shown in “Printer Cable Wiring Diagram” (page E-81).

Symptom	Check Point	Action
Measurement data or settings are not held in memory, and disappear immediately.	The instrument's backup batteries may be low immediately after purchase or following a period of prolonged use. Turn the power of the instrument ON to charge the backup batteries. Under this condition, the batteries can be fully charged in 25 hours.	The backup batteries have an expected service life of approximately ten years. If you find that the instrument fails to retain data in memory even after the batteries have been fully charged, however, then it is likely that your batteries have reached the end of its life and requires replacement. Note that you cannot replace the batteries yourself. For information, please contact a KONICA MINOLTA-authorized service facility.

Chapter 6

Appendix



Principles of Measurement

Illuminating/Viewing System

The measurement flow of the CM-2500c is shown below.

The CM-2500c utilizes 45°a:0° geometry conforming to CIE No.15, ISO 7724/1, ASTM E179, DIN 5033 Teil7, and JIS Z 8722 Condition a (45-degree ring illumination/vertical viewing angle).

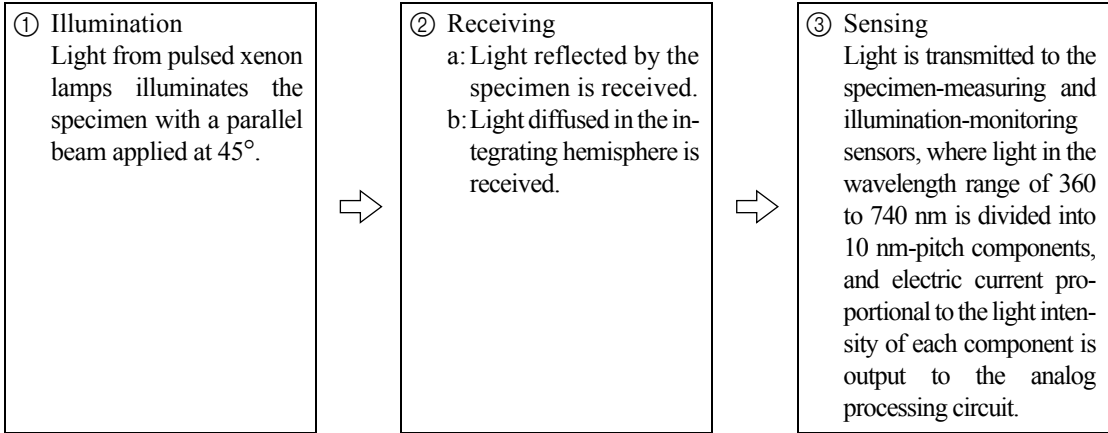

① Light from pulsed xenon lamps diffuses on the inner surface of the integrating hemisphere coated with barium sulfate. The uniform, diffused light inside the integrating hemisphere passes through the illumination slit and reaches the lens. The light that passes through the slit is changed into a parallel beam at 45 degrees by the lens and illuminates the specimen (45-degree illumination).

② a. The light reflected by the specimen surface in the direction of a right angle to the surface is received by the specimen-measuring sensor (0-degree viewing angle).
b. The diffused light in the integrating hemisphere is received by the illumination-monitoring optical system and guided to the sensor.

③ The light reflected by the specimen surface and the light diffused by the inner surface of the integrating hemisphere are divided into each wavelength component by the specimen-measuring sensor and illumination-monitoring sensor respectively. Then, an electric current proportional to the light intensity of each component is output to the analog processing circuit.

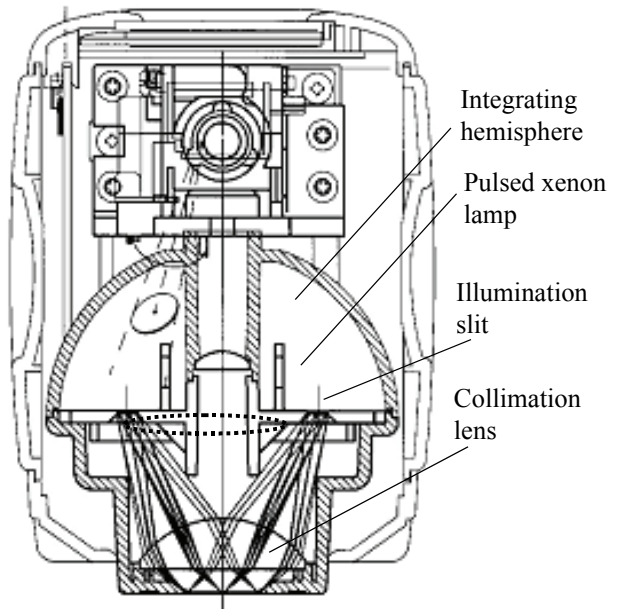

By using the outputs from the specimen-measuring sensor and the illumination-monitoring sensor for the calculation with the CPU, the instrument compensates for slight fluctuations in spectral characteristics and in light intensity of the illumination. (Double-beam system)

Target Mode

Relation Between Measured Data and Target Color

- In “linked to each data.” mode, there is specific target color data associated with the selected number of the target color data at the time of measurement.
- In “defined in COND.” mode, the target color data depends on the conditions.
There is a unique link for the selected number of the target color data at the time of measurement, however, if the number of the target color is changed, the results are recalculated based on the new target color number.

Deleting a Color Difference Target Data

If target color data is deleted, the numbers for other target color data is renumbered.

For example, if target color data numbers T1 to T10 have been set and T2 is deleted, the date that was numbered T3 is renumbered T2 and T4 becomes T3, and so on for the other numbers.

- In “linked to each data.” mode, if the target color data number selected at the time of measurement is modified (deleted or change), then the link to that target color data is cut. The target color data associated with that measurement data is lost forever, and is not recalculated using other target color data.
The color difference display based on the target color data does not occur and pass/fail judgments are not performed, and “-----” is displayed for the color difference. “T---” is displayed for the target color data number.
- In “defined in COND.” mode, there is a link to the target color data number selected at the time of measurement. For example, if the current target color set for T2 was set as T3 at the time of measurement, and even if the actual target color data used at the time of measurement is deleted, the results are calculated and displayed based on the new T2 target color.

Notes on Changing the Target Mode

This instrument comes with two user selectable target modes, “linked to each data.” and “defined in COND.”

Note

- *Once the target mode is changed, previous data will be cleared. It is recommended that you save previous data into other storage media in advance by using the Color Data Software that is optionally available.*
- *For the target mode changing procedure, please read “Selecting the Target Mode” on page E-24.*

Specifications

Model	Spectrophotometer CM-2500c
Illumination/observation system	45°a:0° method (45° ring-shaped illumination, vertical viewing)
Light-receiving element	Silicon photodiode array (dual 40 elements)
Spectral separation device	Diffraction grating
Wavelength range	360 nm to 740 nm
Wavelength pitch	10 nm
Half bandwidth	Approx. 10 nm
Reflectance range	0 to 175%, resolution: 0.01%
Light source	2 pulsed xenon lamps
Measurement time	Approx. 1.5 seconds
Minimum interval between measurements	4 seconds
Battery performance	Approx. 1000 times at 10-second intervals (when alkaline batteries used; at 23°C)
Measurement/illumination area	ø 7 mm/ø 11 mm
Repeatability	Colorimetric Value: Standard deviation within ΔE^*_{ab} 0.05 (Measurement conditions: White calibration plate measured 30 times at 10-second intervals after white calibration was performed)
Inter instrument agreement	Within ΔE^*_{ab} 0.25 (Averaged for 12 BCRA Series II color tiles compared to values measured with master body; at 23°C)
Language modes	English/Japanese/German/French/Spanish/Italian
Measurement mode	Single measurement/automatic averaging of multiple measurements (auto mode: 3, 5, 8 times/manual mode)
Interface	Output: RS-232C serial signals via RJ45 connector; USB 2.0 communication possible when using included USB-Serial Converter Cable IF-A24
Observer	2/10 degrees (CIE 1931/2°, CIE 1964/10°)
Illuminant	A, C, D50, D65, F2, F6, F7, F8, F10, F11, F12 (simultaneous evaluation is possible using two light sources)
Display data	Spectral value/graph, colorimetric value, color difference value/graph, PASS/FAIL result, ASSESSMENTS (Except for Japanese mode)
Color space/colorimetric data	L*a*b*, L*C*h, CMC(1:1), CMC(2:1), CIE94, Hunter Lab, Yxy, Munsell, XYZ, MI, WI (ASTM E313-73), WI (CIE), YI (ASTM E313-73/ASTM D1925), ISO Brightness (ISO 2470), Density status A/T, WI/Tint (CIE), DIN 99 Lab, DIN 99 LCh
Data memory	1700 pieces of data (as SCI/SCE 1 data) * 700 pieces of data in the "defined in COND." mode. * Total of the sample data and color difference target data
Pass/Fail judgment	Tolerance for color difference (Both box and elliptical tolerances can be set)
Power source	4 AA-size batteries or AC Adapter (AC-A305)
Size (W x H x D)	69 x 96 x 193 mm
Weight	Approx. 670 g (without batteries)

Model	Spectrophotometer CM-2500c
Operating temperature/humidity range ^{*1}	5 to 40°C, less than 80% relative humidity at 35°C with no condensation
Storage temperature/humidity range	0 to 45°C, less than 80% relative humidity at 35°C with no condensation
Standard accessories	White Calibration Plate: CM-A145
	USB-Serial Converter Cable: IF-A24
	AC Adapter: AC-A305
	E:AA(R6) alkaline battery × 4
Optional accessories	Zero Calibration Box: CM-A32
	Hard Case: CM-A148
	Dust Cover Set: CM-A149
	Replacement Dust Cover: CM-A152 (polyolefin)
	Color Data Software “SpectraMagic NX” (CM-S100w)
	RS-232C Cable (D-sub 9-pin, for IBM, PC/AT): IF-A16
	Printer Cable (D-sub 9-pin, for serial connection): CR-A75

*1 Operating temperature/humidity range of products for North America: 5 to 40°C, less than 80% relative humidity at 31°C with no condensation

Dimensions

(mm)

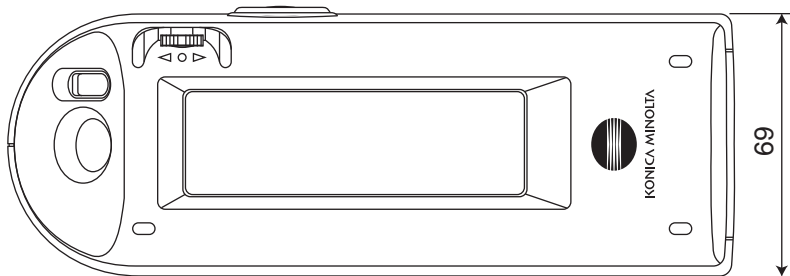
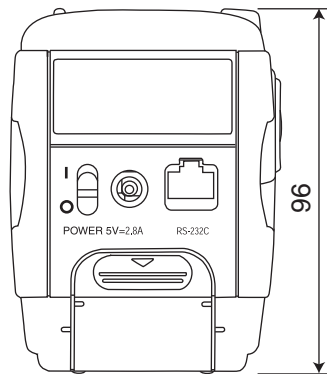
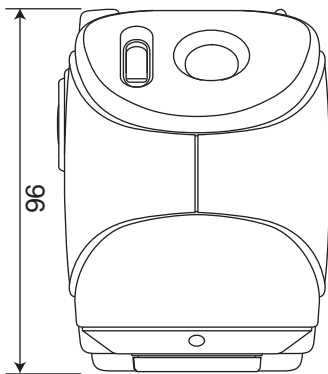
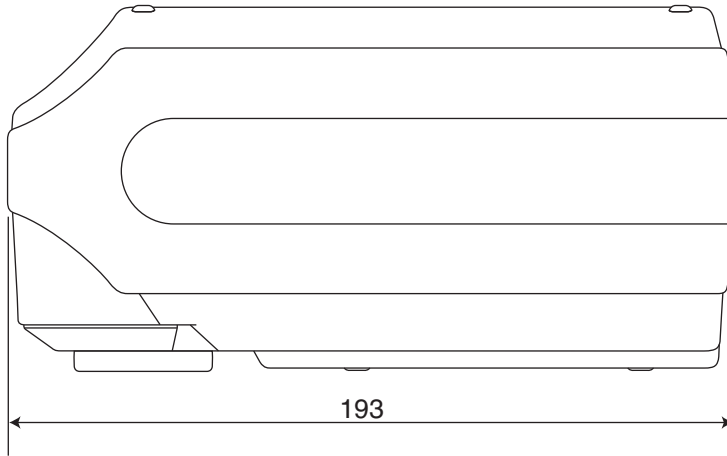



Menu Structure

The navigation wheel of the CM-2500c can be used to select menus and items in the LCD to set the measurement conditions and measurement results display.

The following figure is the Menu Structure diagram of the CM-2500c. This is a tree diagram for the menus or the items that can be selected in the display of the instrument.

Reading the menu structure diagram

- is the display title in the diagram. Then words under the display title are the menus or items which can be selected in this display.
- To the right of the menus or items is explanation of what will happen when the menu or item selected.
- The number enclosed in parentheses “()” in the display is the number of the page in this manual which explains the menu or item. For details, please refer to the indicated page.
- In the following example, it is shown that selecting “COND*” in the “<INITIAL>” display will cause the “COND*” menu for setting measurement conditions to appear.

[Shown in the menu structure]

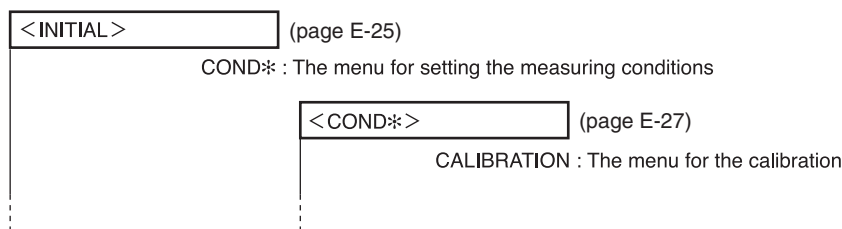

[Real display examples]

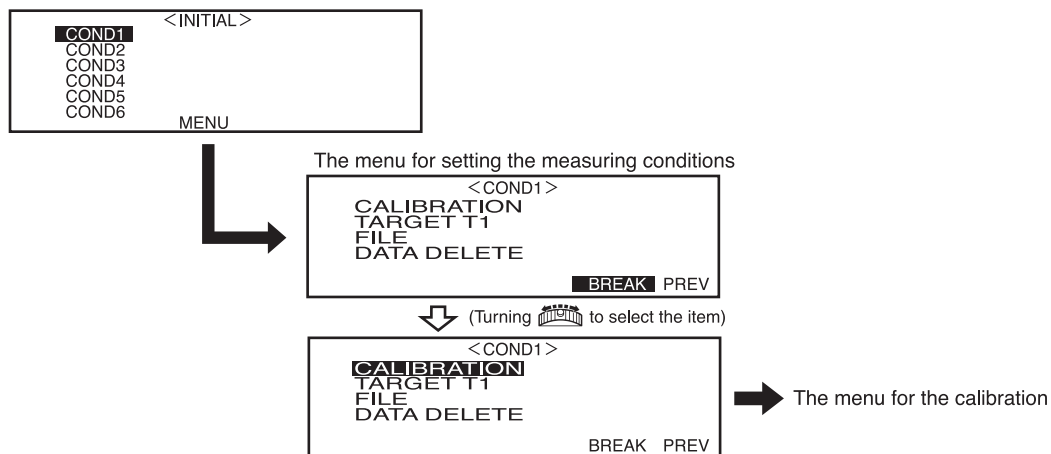

Menu Structure diagram

* Turn the power ON with navigation wheel.

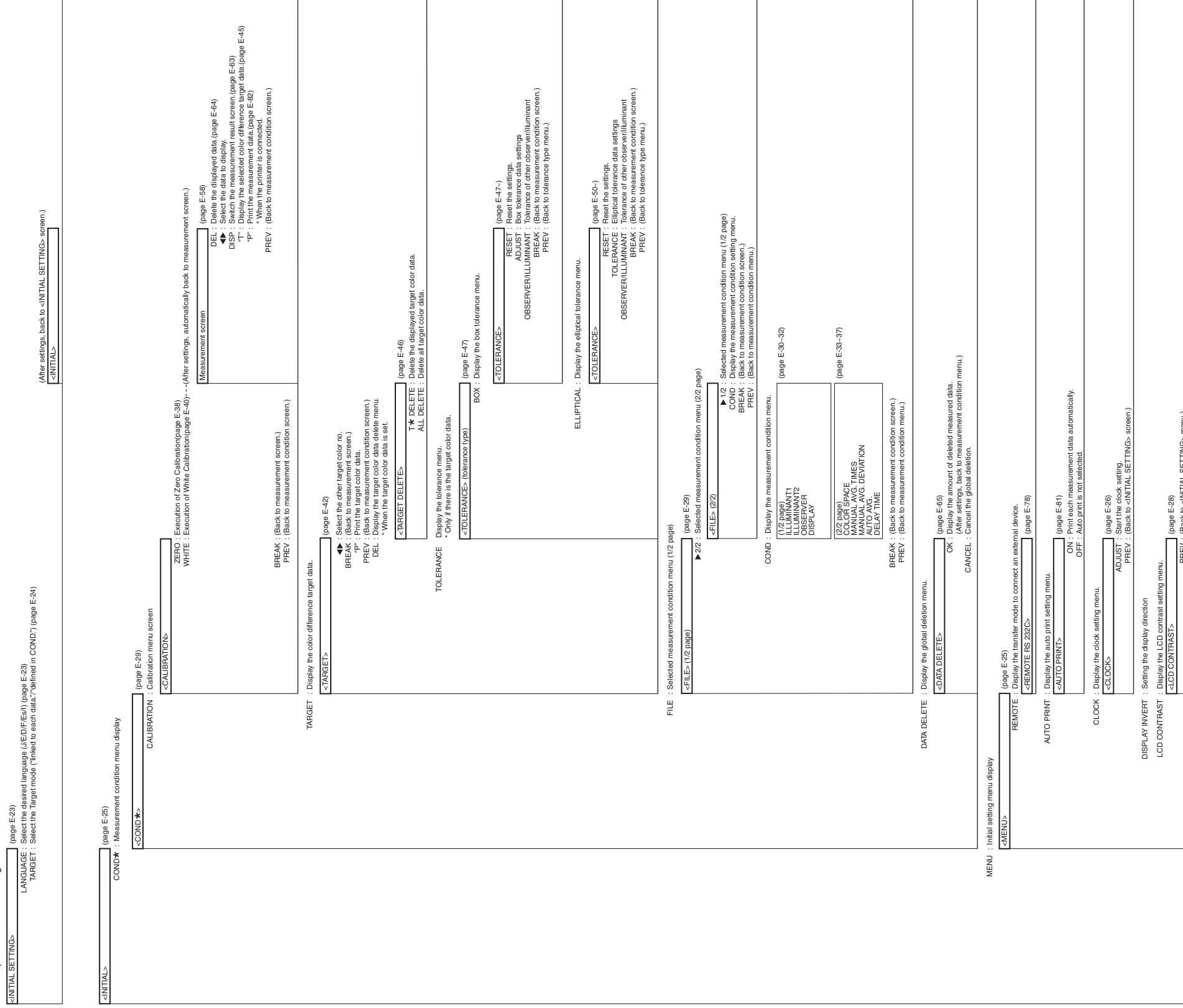



KONICA MINOLTA