



KONICA MINOLTA

Spectrophotometer

CM-26dG

CM-26d

CM-25d



Advanced performance for
the times.

Color Management
for global supply chains.

Highest level of repeatability with high inter-instrument agreement, speed and usability.

The CM-26dG Series from Konica Minolta offers three variations of advanced portable spectrophotometers.

The high-end CM-26dG and CM-26d models bring the industry's highest level of accuracy, with the CM-26dG capable of simultaneously measuring color and gloss, and the CM-26d specifically for measuring color.

The CM-25d is a single aperture model.

Spectrophotometer

CM-26dG | CM-26d | CM-25d

■ 2-in-1 instrument for measuring color and gloss

The CM-26dG performs the job of two instruments by simultaneously measuring color and gloss. The integrated gloss sensor will significantly improve the speed of the inspection process & remove the need for a separate gloss device.

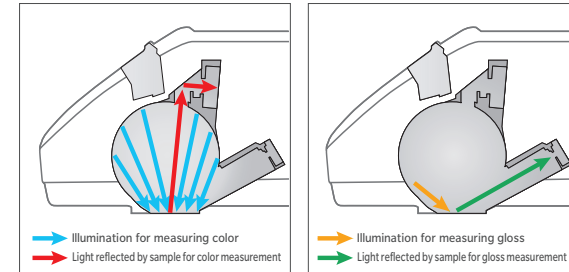

■ Improved measurement speed

The CM-26dG measures color in about half the time of previous models, at approx. 0.7 second (SCI or SCE). Measurements of both color and gloss (SCI or SCE + Gloss) can be made in around 1 second.

The faster measuring speed directly improves efficiency.

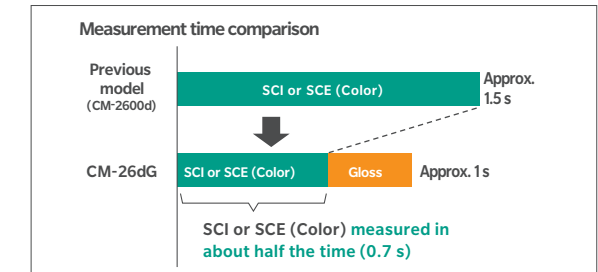

(Actual size)

■ Highest levels of repeatability and inter-instrument agreement amongst portable spectrophotometers

Supply chains are constantly being built and modified, and data needs to be seamlessly shared amongst both internal and external partners. High repeatability and high inter-instrument agreement are increasingly prerequisites for portable spectrophotometers to expedite specification, supply and quality control. The CM-26dG and CM-26d realize the highest level of inter-instrument agreement amongst currently available portable spectrophotometers, at ΔE^*ab 0.12 (BCRA average amongst 12 colors); this is around half that of their predecessor the CM-2600d. When measuring gloss, the inter-instrument agreement of the CM-26dG is within ± 0.2 GU (0-10 GU) or ± 0.5 GU (10-100 GU). The improved accuracy of the CM-26dG will allow supply chains to operate at closer tolerances and facilitate digital color communication, cutting reliance on physical standards, greatly improving timelines and associated costs.

Option Color Data Software SpectraMagic NX2

SpectraMagic NX2 is color management software that gives users a customizable screen display and a wide range of functions for operating and configuring their spectrophotometer or Chroma Meter from a computer. Users can display data lists and create color difference graphs and spectral graphs to assist in color management that requires judgment based on numerous values and indicators.

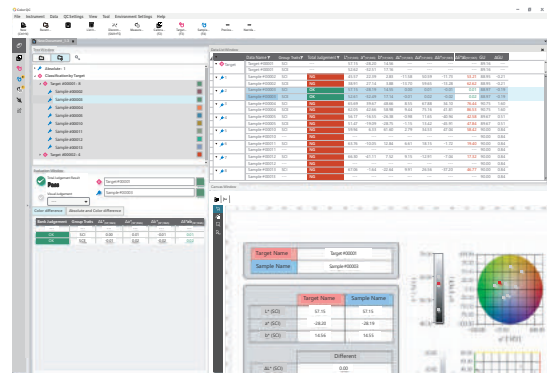

You can see the details in the catalog from the following 2D code. ↓

[SpectraMagic NX2 web Site](#)



Spectrophotometer Configuration Tool CM-CT1 Ver.1.5 or later

The CM-CT1 gives manufacturers the means for easily and quickly setting up their CM-26dG Series spectrophotometers. Moreover, when multiple devices are used or when the same conditions need to be set amongst multiple factories or suppliers, settings can be compiled into a file and shared. Setting of User Index*1 has been added.

*1 :Function is available only with a valid activated SpectraMagic NX2 dongle or dongle-less license.

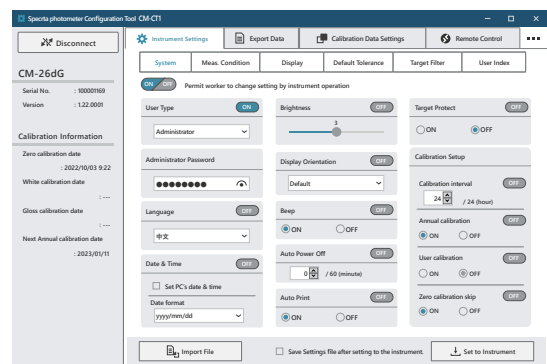

Easily unify measurement conditions and environmental settings amongst spectrophotometers

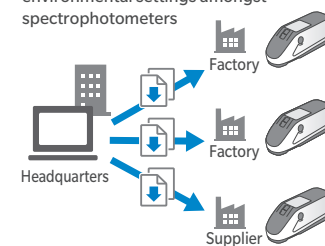

Spectrophotometer Configuration Tool CM-CT1

- OS: Windows® 10 Pro 64 bit Version 1903 or higher / Windows® 11 Pro
- CPU: 2.0 GHz equivalent or faster ●Memory: 2 GB or more ●Hard disk: 10 GB or more of free space for installation
- Other: USB port (For connecting to spectrophotometers and SpectraMagic NX2 dongle)
- Windows® is a trademark or registered trademark of Microsoft Corporation in the USA and other countries.

Viewfinder

The viewfinder brightly illuminates the measurement point with an LED to make target alignment, easier and more precise. The viewfinder of the CM-26dG also includes a target ring that makes it even easier to identify the measurement area.

Using the viewfinder greatly reduces measurement errors when setting measurement points on patterns and prints.



Compact, lightweight streamlined body

Designed to work in hard-to-reach places, the CM-26dG Series spectrophotometers allow users to take measurements where previous models could not. The nose is angled downward and rounded at the corners to get into cramped spots like dashboards at a point near the windshield.

The measurement button is accessible from both sides of the unit, improving usability for left handed operators or in otherwise difficult to reach areas.



JOB function execution screen

(Actual size)

High usability and functional versatility

<JOB Function>

Measurement instructions (including photographs) for routine tasks can be uploaded to the instrument using SpectraMagic NX2 (sold separately).

<WLAN/Bluetooth® ready>

Data can be wirelessly transmitted to computers or other paired devices over a WLAN/Bluetooth connection.

CM-26dG Series spectrophotometers can be used in a wide range of industries.

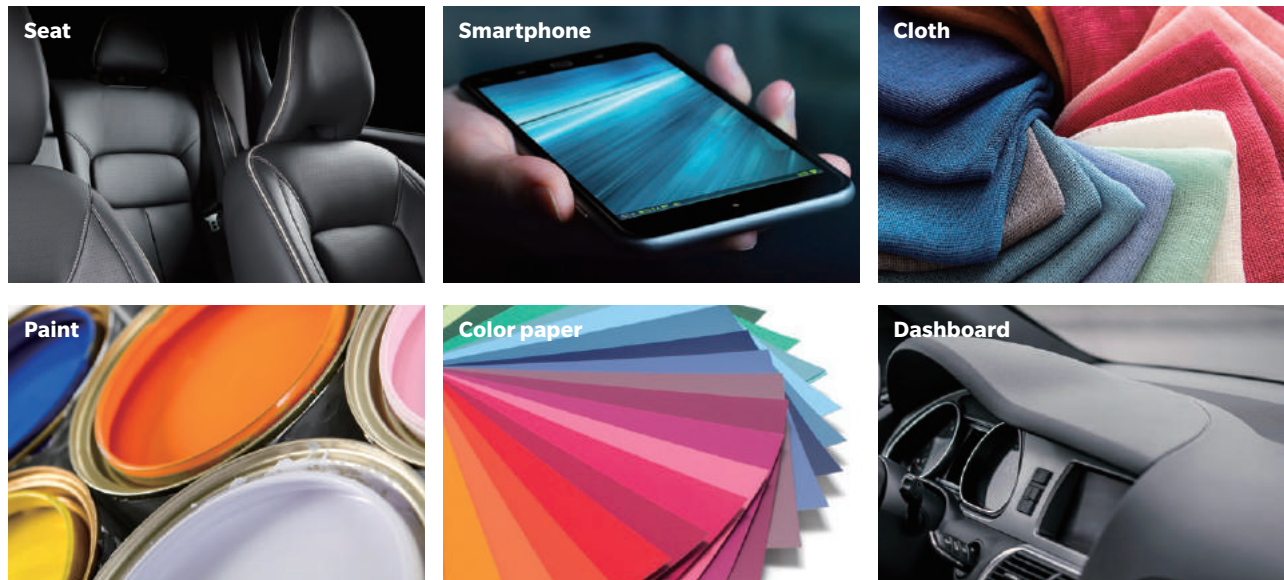

Performance by model (Feature comparison)

	CM-26dG	CM-26d	CM-25d
SCI	●	●	●
SCE	●	●	●
60° gloss	●	—	—
MAV (Ø8 mm)	●	●	●
SAV (Ø3 mm)	●	●	—
UV setting	100% / 0% / Adjusted	100% / 0% / Adjusted	0% only
Inter-instrument agreement (Color)	<0.12	<0.12	<0.20
Repeatability ($\sigma\Delta E^*ab$)	<0.02	<0.02	<0.04
Wavelength range	360 to 740 nm	360 to 740 nm	400 to 700 nm

✓ Standard color automatic selection function

When this function is set, the optimum target color candidates for comparison from among the target colors registered in advance are automatically displayed after sample measurement.

This makes it easy to determine the appropriate target color.

Even when various colors are measured in the inspection process in the automobile industry, etc., there is no need to manually reset the target color before measurement. The target color can be easily selected from the candidates displayed after measurement.

This function can shorten the inspection time.

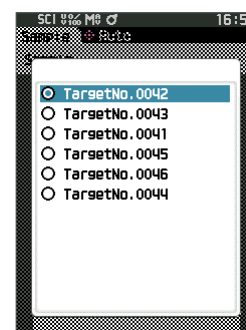

✓ Checking for fluorescent whitening agents and performing simple inspection (CM-26dG/CM-26d only)

Measurements under 100% UV and 0% UV can be taken at the same time and the results can be displayed on the same screen. This feature is useful to check for the presence of optical brighteners and perform simple inspection. By comparing and evaluating data such as reflectance under 100% UV and 0% UV, the characteristics of the base material and the effect of the fluorescent whitening material can be confirmed.

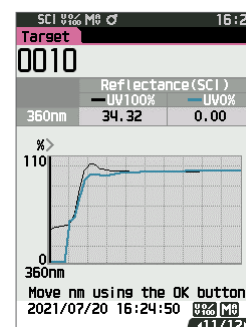

System Diagram

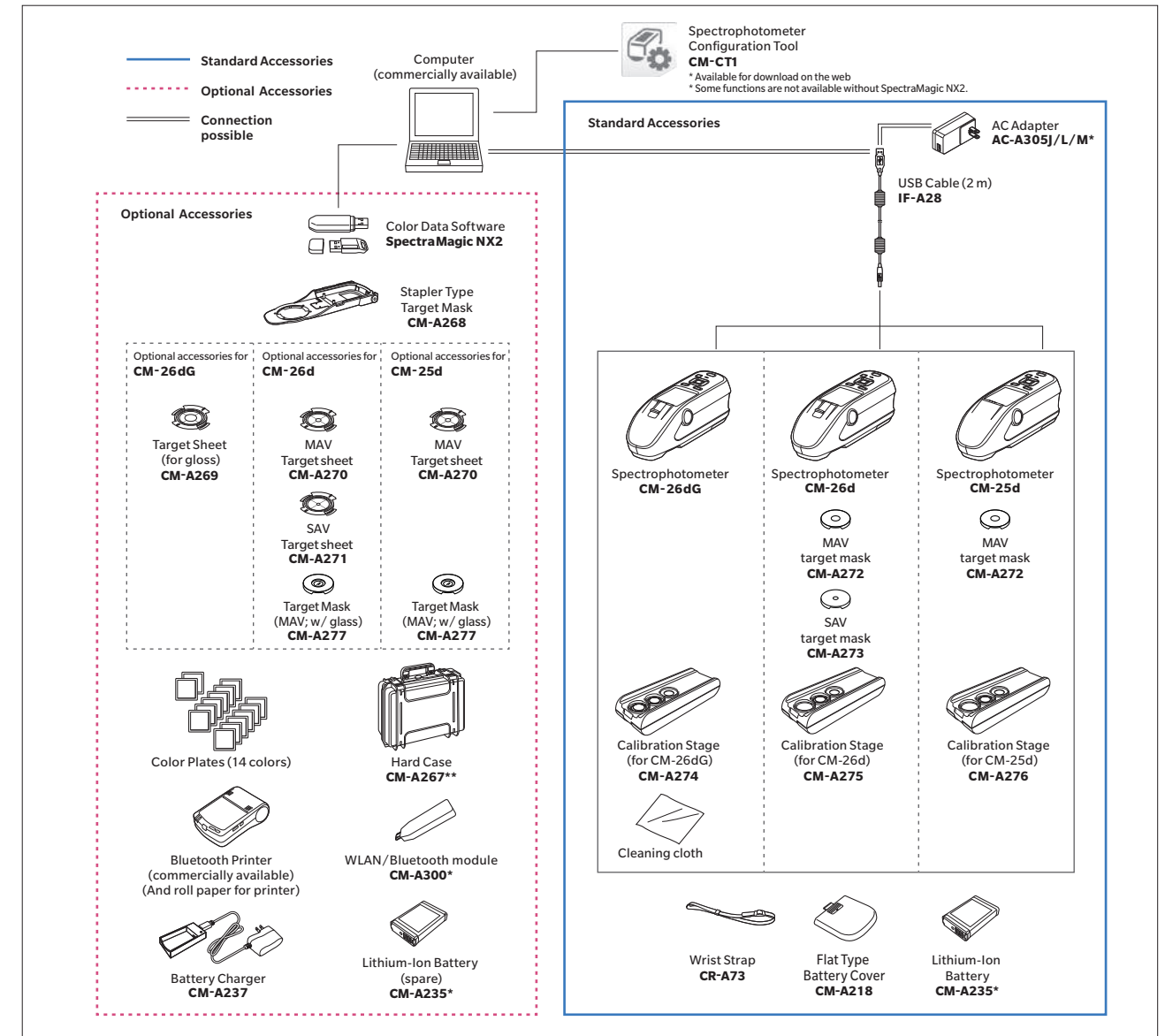

* Depending on the location, some accessories may not be available.
** May be included as a standard accessory in some regions.

Dimensions (Units: mm)

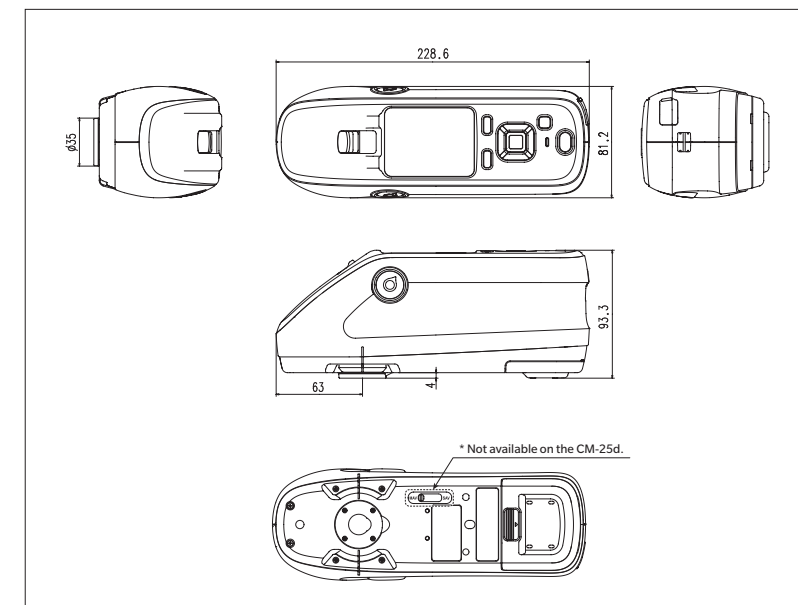

Specifications

	CM-26dG	CM-26d	CM-25d
Color	di: 8°, de: 8° (diffuse illumination: 8° viewing) SCI (spectral component included) / SCE (spectral component excluded) switchable Conforms to CIE No.15 (2004), ISO7724/1, ASTM E1164 (SCI), DIN 5033 Teil7, JIS Z 8722 Condition c standard		
Integrating sphere	Ø54 mm		
Detector	Dual 40-element silicon photodiode arrays	Dual 32-element silicon photodiode arrays	
Spectral separation device	Planar diffraction grating		
Wavelength range	360 to 740 nm		400 to 700 nm
Measurement wavelength pitch	10 nm		
Half bandwidth	Approx. 10 nm		
Reflectance range	0 to 175%; Resolution: 0.01%		
Light source	Pulsed xenon lamp ×2		Pulsed xenon lamp ×1 (with UV cut filter)
Illumination area	12 × 12.5 mm (circle + ellipse)	MAV : Ø12 mm SAV : Ø6 mm	MAV : Ø12 mm
Measurement area	MAV: Ø8 mm, SAV: Ø3 mm		MAV : Ø8 mm
Repeatability	Standard deviation within ΔE*ab 0.02		Standard deviation within ΔE*ab 0.04
Inter-instrument agreement	(When a white calibration plate is measured 30 times at 5-second intervals after white calibration under Konica Minolta standard conditions) Within ΔE*ab 0.12 (Based on average for 12 BCRA Series II color tiles; MAV SCI; compared to values measured with a master body under Konica Minolta standard conditions)		
UV setting	100% / 0% / Adjusted (Instantaneous numerical adjustment of UV with no mechanical filter movement required)*1; 400 nm UV cutoff filter		No adjustment function(UV0%)
Observer	2° Standard Observer, 10° Standard Observer		
Illuminant	A, C, D50, D65, F2, F6, F7, F8, F10, F11, F12, ID50, ID65, User-defined illuminant** (Simultaneous evaluation with two light sources possible)		
Display items	Colorimetric values/graph, color difference values/graph, spectral graph, pass/fail judgment, pseudocolor		
Color spaces	L*a*b*, L*C*h, Hunter Lab, Yxy, XYZ, and color difference in these spaces; Munsell (C)		
Indices	MI; WI (ASTM E313-73); YI (ASTM E313-73; ASTM D1925); ISO brightness (ISO 2470); WI/Tint (CIE/Ganz); Tristimulus Strength; Opacity; Grey Scale (ISO 105-A05), K/S strength (Apparent (ΔE*ab), Maximum absorption, Total wavelength); Staining degree (ISO 105-A04); User index*3	MI; W (I ASTM E313-73); YI (ASTM E313-73; ASTM D1925); ISO brightness (ISO 2470); WI/Tint (CIE/Ganz); Tristimulus Strength; Opacity; Grey Scale (ISO 105-A05); 8° gloss value; K/S strength (Apparent (ΔE*ab), Maximum absorption, Total wavelength); Staining degree (ISO 105-A04); User index*3	MI; W (I ASTM E313-73); YI (ASTM E313-73; ASTM D1925); ISO brightness (ISO 2470); WI/Tint (CIE); Tristimulus Strength; Opacity; Grey Scale (ISO 105-A05); 8° gloss value; K/S strength (Apparent (ΔE*ab), Maximum absorption, Total wavelength); Staining degree (ISO 105-A04); User index*3
Color difference equations	ΔE*ab (CIE1976); ΔE*94 (CIE1994); ΔE00 (CIEDE2000); CMC (l:c); Hunter ΔE; DIN990; FMC-2		
Gloss	Measurement angle: 60° Light source: White LED Detector: Silicon photodiode Color sensitivity: Spectrally adjusted to CIE photopic luminous efficiency V(λ) under CIE illuminant C Measurement range: 0 to 200 GU; Resolution: 0.01 GU Measurement area: MAV: 10×7 mm ellipse, SAV: Ø3 mm Repeatability: Standard deviation 0 to 10 GU: Within 0.1 GU, 10 to 100 GU: Within 0.2 GU, 100 to 200 GU: Within 0.2% (When measured 30 times at 5-second intervals under Konica Minolta standard measurement conditions) Inter-instrument agreement: 0 to 10 GU: Within ± 0.2 GU, 10 to 100 GU: Within ± 0.5 GU (MAV; compared to values measured with a master body under Konica Minolta standard measurement conditions) Applicable standards: JIS Z8741 (MAV), JIS K5600, ISO 2813, ISO 7668 (MAV), ASTM D523-08, ASTM D2457-13, DIN 67530		
Measurement time	Approx. 1 seconds (Measurement mode: SCI+Gloss or SCE+Gloss)	Approx. 0.7 s (Measurement mode: SCI or SCE)	
Minimum measurement interval	Approx. 2 seconds (Measurement mode: SCI+Gloss or SCE+Gloss)	Approx. 1.5 s (Measurement mode: SCI or SCE)	
Data memory	1,000 target data + 5,100 sample data		
Battery performance	Measurement mode: SCI + Gloss or SCE + Gloss	Measurement mode: SCI or SCE	
Viewfinder function	Available (with white LED illumination)		
Display	2.7-inch TFT color LCD with reversible portrait viewing mode		
Display language	English, Japanese, German, French, Italian, Spanish, Simplified Chinese, Portuguese, Russian, Turkish, Polish		
Interface	USB 2.0 Bluetooth (SPP-compatible)* WLAN (802.11 a/b/g/n)* * Optional WLAN / Bluetooth module required WLAN security supports WPA2-PSK (WPA2-Personal) and WPA-PSK (WPA-Personal) for the AdHoc method, and WPA3-PSK (WPA3-Personal), WPA2-PSK (WPA2-Personal) and WPA-PSK (WPA-Personal) for the Infrastructure method.		
Power	Dedicated lithium-ion battery (removable), USB bus power (with lithium-ion battery installed), Dedicated AC adapter (with lithium-ion battery installed)		
Charging time	Approx. 6 h		
Operating temperature/humidity range	Temperature: 5 to 40°C; Relative humidity: 80% or less (at 35°C) with no condensation		
Storage temperature/humidity range	Temperature: 0 to 45°C; Relative humidity: 80% or less (at 35°C) with no condensation		
Size	Approx. 81 (W) × 93 (H) × 229 (D) mm		
Weight	Approx. 660 g	Approx. 630 g	Approx. 620 g

*1 Firmware version 1.10 or later and optional Color Data Software SpectraMagic NX2 Pro is required to use UV Adjusted setting.

*2 Optional Color Management Software SpectraMagic NX2 is required for setting user-configured illuminants.

*3 Spectrophotometer Configuration Tool CM-CT1 (Ver. 1.4 or later) and a valid Color Data Software SpectraMagic NX2 license are required for setting user indexes.

- KONICA MINOLTA, the Konica Minolta logo and symbol mark, "Giving Shape to Ideas" and SpectraMagic are registered trademarks or trademarks of Konica Minolta, Inc.
- Bluetooth® is a registered trademark of Bluetooth SIG, Inc. and is used under license agreement.
- Displays shown are for illustration purpose only.
- The specifications and appearance shown herein are subject to change without notice.

SAFETY PRECAUTIONS



For correct use and for your safety, be sure to read the instruction manual before using the instrument.

● Always connect the instrument to the specified power supply voltage. Improper connection may cause a fire or electric shock.



JQA-QMA15888 Design, development, manufacture/
 manufacturing management, calibration, and
 service of measuring instruments

JQA-E-80027 Design, development,
 manufacture, service and sales
 of measuring instruments

KONICA MINOLTA, INC.	Osaka, Japan		
Konica Minolta Sensing Americas, Inc.	New Jersey, U.S.A.	PHONE: (888)473-2656 (in USA), +1(201)236-4300 (outside USA)	FAX: +1(201)785-2480 E-Mail: service.us@konicaminolta.com
Konica Minolta Sensing Europe B.V.	European HQ / BENELUX	Nieuwegein, Netherlands	PHONE: +31(0)30 248-1193 E-Mail: info.benelux@seu.konicaminolta.eu
	German Office	München, Germany	PHONE: +49(0)89 4357 156 0 E-Mail: info.germany@seu.konicaminolta.eu
	French Office	Roissy CDG Cedex, France	PHONE: +33(0)1 80 11 10 70 E-Mail: info.france@seu.konicaminolta.eu
	UK Office	Warrington, United Kingdom	PHONE: +44(0)1925 467300 E-Mail: info.uk@seu.konicaminolta.eu
	Italian Office	Cinisello Balsamo, Italy	PHONE: +39 02849488.00 E-Mail: info.italy@seu.konicaminolta.eu
	Swiss Office	Dietikon, Switzerland	PHONE: +41(0)43 322-9800 E-Mail: info.switzerland@seu.konicaminolta.eu
	Nordic Office	VÅSTRA FRÖLUNDA, Sweden	PHONE: +46(0)31 7099464 E-Mail: info.nordic@seu.konicaminolta.eu
	Polish Office	Wrocław, Poland	PHONE: +48(0)71 73452-11 E-Mail: info.poland@seu.konicaminolta.eu
Konica Minolta (CHINA) Investment Ltd.	SE Sales Division	Shanghai, China	PHONE: +86-(0)21-6057-1089 E-Mail: hcn_sensing@gcp.konicaminolta.com
	Beijing Office	Beijing, China	PHONE: +86-(0)10-8522 1551 E-Mail: hcn_sensing@gcp.konicaminolta.com
	Guangzhou Office	Guangzhou, China	PHONE: +86-(0)20-3826 4220 E-Mail: hcn_sensing@gcp.konicaminolta.com
	Chongqing Office	Chongqing, China	PHONE: +86-(0)23-6773 4988 E-Mail: hcn_sensing@gcp.konicaminolta.com
	Qingdao Office	Shandong, China	PHONE: +86-(0)532-8079 1871 E-Mail: hcn_sensing@gcp.konicaminolta.com
	Wuhan Office	Hubei, China	PHONE: +86-(0)27-6885 0586 E-Mail: hcn_sensing@gcp.konicaminolta.com
	Shenzhen Office	Shenzhen, China	PHONE: +86-(0)755-2868 7535 E-Mail: hcn_sensing@gcp.konicaminolta.com
	Xiamen Office	Xiamen, China	PHONE: +86-(0)592-7107 399 E-Mail: hcn_sensing@gcp.konicaminolta.com
Konica Minolta Sensing Singapore Pte. Ltd.	Singapore		PHONE: +65 6563-5533 E-Mail: se-service.sg@konicaminolta.com
Konica Minolta Sensing Korea Co., Ltd.	Korean HQ	Goyang-si, Korea	PHONE: +82(0)2-523-9726 E-Mail: se.korea@konicaminolta.com
	Cheonan Office	Cheonan-si, Korea	PHONE: +82(0)41-556-9726 E-Mail: se.korea@konicaminolta.com

Addresses and telephone/fax numbers and e-mail address are subject to change without notice. For the latest contact information, please refer to KONICA MINOLTA Worldwide Offices web page:

<https://konicaminolta.com/instruments/network>