



KONICA MINOLTA

Spectrophotometer  
**CM-36dG**  
**CM-36dGV**  
**CM-36d**



Advanced functions for today's needs  
Data consistency with past models

The Standard in Measuring Color & Light

Giving Shape to Ideas

## Spectrophotometer

### CM-36dG | CM-36dGV | CM-36d

Three models to choose from:

CM-36dG: Horizontal format model offering simultaneous color and gloss measurements, UV adjustment function.

CM-36dGV: Vertical format model with same functions as CM-36dG for textile or paper measurements.

CM-36d: Basic model for spectral reflectance color measurements.



## ■ Two-in-one instruments for simultaneous color and gloss measurements

The CM-36dG and CM-36dGV are two-in-one spectrophotometers that can measure both color and gloss simultaneously. Simultaneous measurement of color and gloss increases work efficiency and can be used for advanced quality control or color-matching calculations.

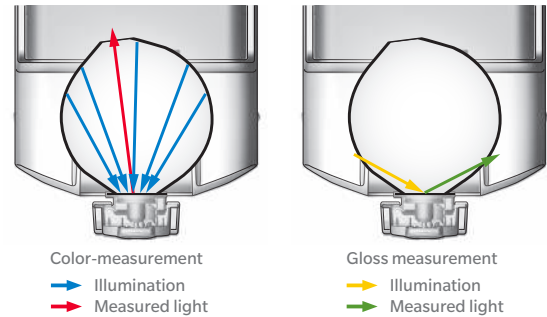

## ■ Wavelength Analysis & Adjustment for high stability (Option\*)

WAA (Wavelength Analysis & Adjustment; available with license purchase) provides worry-free, higher-reliability measurements and minimizes system problems by suppressing shifts in measurement values due to sudden temperature changes, etc. The data required for performing analysis and adjustment are obtained during white calibration, so no extra work is necessary.

\* Option; License required. Please contact your local Konica Minolta distributor for more information.

## ■ High inter-instrument agreement and data consistency with previous models

The CM-36dG and CM-36dGV offer high inter-instrument agreement to allow higher work efficiency when using multiple units or units at multiple locations. Colorimetric inter-instrument agreement is within  $\Delta E^*_{ab}$  0.12 (LAV/SCI), a 20% improvement compared to previous models, and gloss inter-instrument agreement is also the same or better than the performance of gloss-only instruments.

Inter-model agreement with the previous CM-3600A Series is also high, so the same target data can continue to be used, reducing the work required for switching to the CM-36dG Series (for SCI measurements).

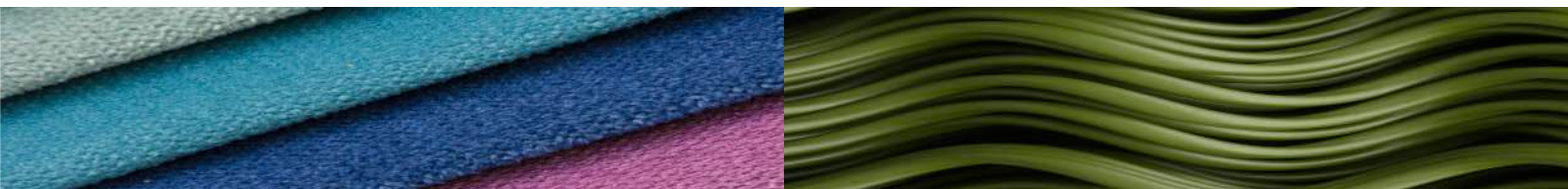

**Contributes to digital quality control in the supply chain by providing high-precision simultaneous measurements of color and gloss.**



## ■ High usability for improved productivity

- ✓ Status panel displays measurement status and condition settings to reduce operator mistakes.
- ✓ Measurements can be performed using the measuring button on the instrument, improving operability when taking a series of measurements.

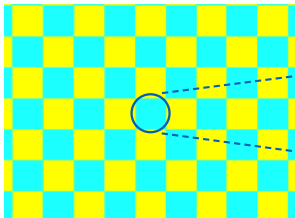

Measurement subject

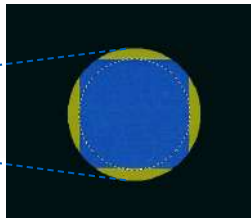

Sample viewer image

- ✓ Sample viewer function\* allows software to show the view from inside the instrument, making sample positioning easier.

\* SpectraMagic NX or other software required.

## ■ Color Data Software SpectraMagic NX

SpectraMagic NX is color management software that gives users a plethora of functions for viewing data and for operating and configuring their spectrophotometers from a computer. Users can customise templates and reports by arranging and editing spectral graphs, color difference graphs (2D, 3D), PASS/FAIL indications and other objects to suit their needs.

**SpectraMagic NX Ver. 3.2 or later** ● OS: Windows® 8.1 Pro 32 bit, 64 bit / Windows® 10 Pro 32 bit, 64 bit

\* The computer must be running one of the above OS and meet or exceed the below specifications. ● CPU: Pentium® III 600 MHz equivalent or faster ● Memory: 128 MB or more (256 MB or more recommended) ● Hard disk: 450 MB or more of free space for installation ● Display: Resolution: 1,024 x 768 pixels or more/ 16-bit colors or more ● Other: DVD-ROM drive (for software installation), USB port (for entering the protection key), USB or serial port (for connecting to spectrophotometers) and Internet Explorer Ver. 5.01 or later installed  
 ○ Windows® is a trademark or registered trademark of Microsoft Corporation in the USA and other countries. ○ Pentium® is a trademark or registered trademark of Intel Corporation in the USA and other countries.

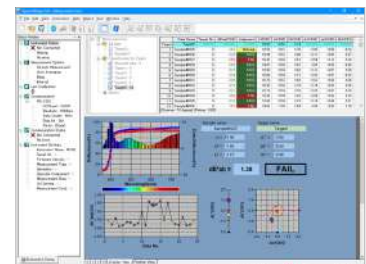

# Usability

## ■ Handles a wide variety of measurement subjects

- ✓ Target masks for 4 measurement areas can be selected according to the sample size.
- ✓ Transmittance chamber opens widely to allow measurement of even large samples. Sheets, etc. can be set in position from the side without having to cut them.
- ✓ The orientation of CM-36dG/CM-36d can be changed according to the measurement object.



## ■ UV adjustment for accurate measurements of fluorescent materials

Accurate measurement of materials such as paper or cloth treated with fluorescent whitening agents (FWA) requires precise control of the UV component and its effects. The Numerical UV Control method used by the CM-36dG and CM-36dGV provides such control by combining results from flashes of two xenon lamps (one with full UV energy, the other with UV energy removed by a 400 nm or 420 nm UVcutoff filter) using proprietary calculations. This method eliminates the need for mechanical filter positioning, and enables UV adjustment by Whiteness Index, Tint, Brightness, or UV profile.

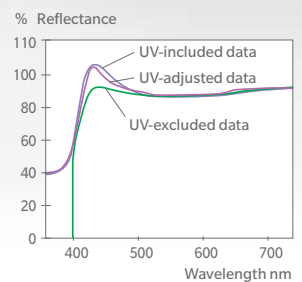

## ■ CM-36dGV

CM-36dGV provides the same functions as the CM-36dG in a vertical format for textile or paper measurements.



# Multipurpose



■ **CM-36dG Series spectrophotometers can be used in a wide range of industries.**

Paint, plastics, textile, glass, film, etc.



■ **Performance by model**

		CM-36dG	CM-36dGV	CM-36d
Color	Reflectance (SCI/SCE)	●	●	●
	Transmittance	●	●	—
	Measurement area	LAV, LMAV, MAV, SAV		LAV, MAV, SAV
	UV condition setting	100%, 0%, Adjusted		100%
	Repeatability	≤0.02	≤0.02	≤0.03
	Inter-instrument agreement (LAV, SCI)	≤0.12	≤0.12	≤0.15
Gloss	60° gloss measurements	●	●	—
	Measurement area	MAV, SAV		—
Instrument format		Horizontal	Vertical	Horizontal

		CM-36dG			CM-36dGV			CM-36d			
Color	Illumination / viewing system	Reflectance	di: 8°, de: 8° (diffused illumination, 8° viewing), SCI (specular component included)/SCE (specular component excluded) switchable Conforms to CIE No.15 (2004), ISO7724/1, ASTM E1164, DIN 5033 Teil7, JIS Z 8722 Condition c standard								
		Transmittance	di:0°, de:0° (diffused illumination, 0° viewing) Conforms to CIE No.15 (2004), ASTM E1164, DIN 5033 Teil7, JIS Z 8722 Condition g standard						—		
	Size of integrating sphere	Ø152 mm (6 inches)									
	Detector	Dual 40-element silicon photodiode arrays									
	Spectral separation device	Diffraction grating									
	Wavelength range	360 to 740 nm									
	Wavelength pitch	10 nm									
	Half bandwidth	Approx. 10 nm									
	Reflectance range	0 to 200%; Resolution: 0.01%									
	Light source	Pulsed xenon lamps × 3 (2 with UV cut filters)						Pulsed xenon lamp × 1			
		LAV	LMAV	MAV	SAV	Transmittance	LAV	MAV	SAV		
	Illumination area	Ø30 mm	Ø20 mm	Ø11 mm	Ø7 mm	Ø24 mm	Ø30 mm	Ø11 mm	Ø7 mm		
	Measurement area	Ø25.4 mm	Ø16 mm	Ø8 mm	Ø4 mm	Ø17 mm	Ø25.4 mm	Ø8 mm	Ø4 mm		
	Repeatability	Colorimetric values: Standard deviation within ΔE*ab 0.02 Spectral reflectance: Standard deviation within 0.1% (When a white calibration plate is measured 30 times at 10-second intervals after white calibration)						Colorimetric values: Standard deviation within ΔE*ab 0.03 Spectral reflectance: Standard deviation within 0.1% (When a white calibration plate is measured 30 times at 10-second intervals after white calibration)			
Inter-instrument agreement	Within ΔE*ab 0.12 (Based on average for 12 BCRA Series II color tiles; LAV/SCI. Compared to values measured with a master body under Konica Minolta standard measurement conditions)						Within ΔE*ab 0.15 (Based on average for 12 BCRA Series II color tiles; LAV/SCI. Compared to values measured with a master body under Konica Minolta standard measurement conditions)				
UV setting	100% / 0% / Adjusted (Instantaneous numerical adjustment of UV with no mechanical filter movement required)*; 400 nm and 420 nm UV cutoff filters						No adjustment function (UV100%)				
Gloss	Measurement angle	60°						—			
	Light source	White LED						—			
	Detector	Silicon photodiode						—			
	Measurement range	0 to 200 GU; Resolution: 0.01 GU						—			
	Measurement area	MAV (LAV/LMAV/MAV color measurement area): 10 × 8 mm ellipse SAV (SAV color measurement area): Ø3 mm						—			
	Repeatability	Standard deviation within 0 to 10 GU : 0.1 GU 10 to 100 GU : 0.2 GU 100 to 200 GU : 0.2% (When measured 30 times at 10-second intervals)						—			
	Inter-instrument agreement	0 to 10 GU : ±0.2 GU 10 to 100 GU : ±0.5 GU (MAV. Compared to values measured with a master body under Konica Minolta standard conditions)						—			
Geometry	JIS Z 8741 (MAV), JIS K 5600, ISO 2813, ISO7668 (MAV), ASTM D523-08, ASTM D2457-13, DIN 67530										
Measurement time	SCI+SCE: Approx. 3.5 s SCI+SCE+GLOSS: Approx. 4 s Transmittance: Approx. 2.5 s UV-cut/UV-adjusted; SCI or SCE: Approx. 3 s						SCI+SCE: Approx. 3.5 s				
Minimum interval between measurements	SCI+SCE: Approx. 4 s SCI+SCE+GLOSS: Approx. 4.5 s Transmittance: Approx. 3 s UV-cut/UV-adjusted; SCI or SCE: Approx. 4 s						SCI+SCE: Approx. 4 s				
Sample viewer function	Using internal camera. Image viewable/copiable using optional software such as SpectraMagic NX Ver. 3.2 or later										
Internal Performance Check <sup>2</sup>	WAA (Wavelength Analysis & Adjustment) Technology										
Interface	USB2.0										
Target mask auto detection	Yes										
Power	Dedicated AC adapter										
Operating temperature / humidity range	Temperature: 13 to 33°C, Relative humidity: 80% or less (at 33°C) with no condensation										
Storage temperature / humidity range	Temperature: 0 to 40°C, Relative humidity: 80% or less (at 35°C) with no condensation										
Size (W×H×D)	Approx. 248×250×498 mm			Approx. 300×677×315 mm			Approx. 248×250×498 mm				
Weight	Approx. 8.4 kg			Approx. 14.0 kg			Approx. 8.3 kg				
Standard Accessories	White Calibration Plate; Target Masks (LAV, LMAV, MAV, SAV); Gloss Calibration Plate; Zero Calibration Box; USB Cable (2 m); AC Adapter; Dust Cover; Accessory Case; Cleaning Cloth			White Calibration Plate; Target Masks (LAV, LMAV, MAV, SAV); Gloss Calibration Plate; Zero Calibration Box; USB Cable (2 m); AC Adapter; Dust Cover; Accessory Case; Cleaning Cloth			White Calibration Plate; Target Masks (LAV, MAV, SAV); Zero Calibration Box; USB Cable (2 m); AC Adapter; Dust Cover; Accessory Case				
Optional Accessories	Color Data Software SpectraMagic NX; Transmittance Specimen Holder; Cells (Glass; 2 mm, 10 mm, 20 mm); Plastic Cells (2 mm, 10 mm, 20 mm); Transmittance Zero Calibration Plate; Calibration Glass (for Petri Dish); Petri Dish; Target Mask (for Petri Dish); Color Plates			Color Data Software SpectraMagic NX; Transmittance Specimen Holder; Transmittance Zero Calibration Plate; Opacity Jig; Color Plates			Color Data Software SpectraMagic NX; Calibration Glass (for Petri Dish); Petri Dish; Target Mask (for Petri Dish); Color Plates				

\*1 Numerical adjustment of UV requires UV Adjustment Software (included with optional SpectraMagic NX Pro Ver. 3.2 or later)

\*2 WAA license purchase required.

- Windows® is a trademark or registered trademark of Microsoft Corporation in the USA and other countries.
- KONICA MINOLTA, the Konica Minolta logo and symbol mark, "Giving Shape to Ideas" and SpectraMagic™ are registered trademarks or trademarks of KONICA MINOLTA, INC.
- Displays shown are for illustration purposes only.
- The specifications and appearance shown herein are subject to change without notice.



**SAFETY PRECAUTIONS**

For correct use and for your safety, be sure to read the instruction manual before using the instrument.

- Always connect the instrument to the specified power supply voltage. Improper connection may cause a fire or electric shock.

ISO Certifications of KONICA MINOLTA, Inc., Sakai Site



ISO 9001

JQA-QMA15888  
Design, development, manufacture/  
manufacturing management, calibration,  
and service of measuring instruments



ISO 14001

JQA-E-80027  
Design, development, manufacture,  
service and sales  
of measuring instruments

The latest catalog can be found here:



Catalog appendix (accessories, dimensions, etc.):



<b>KONICA MINOLTA, INC.</b>	Osaka, Japan			
<b>Konica Minolta Sensing Americas, Inc.</b>	New Jersey, U.S.A.	PHONE: (888)473-2656 (in USA), +1(201)236-4300 (outside USA)	FAX: +1(201)785-2480	E-Mail: service.us@konicaminolta.com
<b>Konica Minolta Sensing Europe B.V.</b>	European HQ / BENELUX German Office French Office UK Office Italian Office Swiss Office Nordic Office Polish Office Turkish Office	Nieuwegein, Netherlands München, Germany Roissy CDG Cedex, France Warrington, United Kingdom Cinisello Balsamo, Italy Dietikon, Switzerland VÄSTRA FRÖLUNDA, Sweden Wrocław, Poland Istanbul, Turkey	PHONE: +31(0)30 248-1193 PHONE: +49(0)89 4357 156 0 PHONE: +33(0)1 80 11 10 70 PHONE: +44(0)1925 467300 PHONE: +39 02849488.00 PHONE: +41(0)43 322-9800 PHONE: +46(0)31 7099464 PHONE: +48(0)71 73452-11 PHONE: +90(0)216-528 56 56	E-Mail: info.benelux@seu.konicaminolta.eu E-Mail: info.germany@seu.konicaminolta.eu E-Mail: info.france@seu.konicaminolta.eu E-Mail: info.uk@seu.konicaminolta.eu E-Mail: info.italy@seu.konicaminolta.eu E-Mail: info.switzerland@seu.konicaminolta.eu E-Mail: info.nordic@seu.konicaminolta.eu E-Mail: info.poland@seu.konicaminolta.eu E-Mail: info.sensing@konicaminolta.com.tr
<b>Konica Minolta (CHINA) Investment Ltd.</b>	SE Sales Division Beijing Office Guangzhou Office Chongqing Office Qingdao Office Wuhan Office Shenzhen Office	Shanghai, China Beijing, China Guangzhou, China Chongqing, China Shandong, China Hubei, China Shenzhen, China	PHONE: +86-(0)21-6057-1089 PHONE: +86-(0)10-8522 155 1 PHONE: +86-(0)20-3826 4220 PHONE: +86-(0)23-6773 4988 PHONE: +86-(0)532-8079 1871 PHONE: +86-(0)27-8544 9942 PHONE: +86-(0)755-2868 7535	E-Mail: hcn_sensing@gcp.konicaminolta.com E-Mail: hcn_sensing@gcp.konicaminolta.com E-Mail: hcn_sensing@gcp.konicaminolta.com E-Mail: hcn_sensing@gcp.konicaminolta.com E-Mail: hcn_sensing@gcp.konicaminolta.com E-Mail: hcn_sensing@gcp.konicaminolta.com E-Mail: hcn_sensing@gcp.konicaminolta.com
<b>Konica Minolta Sensing Singapore Pte. Ltd.</b>	Singapore	PHONE: +65 6563-5533		E-Mail: se-service.sg@konicaminolta.com
<b>Konica Minolta Sensing Korea Co., Ltd.</b>	Korean HQ / Kintex Cheonan Office	Goyang-si, Korea Cheonan-si, Korea	PHONE: +82(0)2-523-9726 PHONE: +82(0)41-556-9726	FAX: +82(0)31-995-6511

Addresses and telephone/fax numbers and e-mail address are subject to change without notice.  
For the latest contact information, please refer to KONICA MINOLTA Worldwide Offices web page:

<https://konicaminolta.com/instruments/network>