

CHROMA METER

CS-100A

INSTRUCTION MANUAL

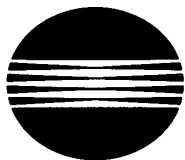

KONICA MINOLTA

Safety Symbols

The following symbols are used in this manual to prevent accidents which may occur as result of incorrect use of the instrument.



Denotes a sentence regarding safety warning or note.
Read the sentence carefully to ensure safe and correct use.



Denotes a prohibited operation.
The operation must never be performed.



Denotes an instruction.
The instruction must be strictly adhered to.



Denotes a prohibited operation.
Never disassemble the instrument.

⚠ SAFETY PRECAUTIONS

- To ensure correct use of this instrument read the following points carefully and adhere to them. After you have read this manual, keep it in a safe place where it can be referred to anytime a question arises.

⚠ WARNING (Failure to adhere to the following points may result in death or serious injury.)	
<p> Do not use the instrument in places where flammable or combustible gases (gasoline etc.) are present. Doing so may cause a fire.</p>	<p> Do not disassemble or modify the instrument. Doing so may cause a fire or electric shock.</p>
<p> Do not dispose of batteries in fire, short their terminals, apply heat to them, or disassemble them. Also, do not recharge them. Doing so may cause explosion or heat generation, resulting in fire or injury.</p>	<p> Take special care not to allow liquid or metal objects to enter the CS-100A. Doing so may cause a fire or electric shock. Should liquid or metal objects enter the instrument, turn the power OFF immediately, remove the batteries, and contact the nearest Konica Minolta authorized service facility.</p>
<p> Never aim the instrument directly at the sun and look through the viewfinder. Doing so can damage your eyes and the instrument.</p>	

⚠ CAUTION (Failing to adhere to the following points may result in injury or damage to the instrument or other property.)	
<p> Do not walk while looking through the viewfinder. Doing so may cause you to trip or bump something.</p>	<p> Do not use batteries other than those specified by Konica Minolta. When installing batteries in the instrument, make sure that they are correctly oriented according to the (+) and (-) marks. Failure to adhere to these instructions may cause explosion of the batteries or leakage of electrolyte, resulting in fire, injury or air pollution.</p>

The Chroma Meter CS-100A is a lightweight, compact meter for taking non-contact color measurements of light sources or reflective surfaces. It combines Konica Minolta's years of experience in optics and colorimetry with advanced electronics for accuracy, portability, and easy operation.

The CS-100A has a 1° acceptance angle, and the through-the-lens viewing system accurately indicates the area to be measured. This system reduces flare, and results in measurements which are relatively unaffected by sources outside the indicated area. The CS-100A uses three high-sensitivity silicon photocells, filtered to closely match the CIE (Commission Internationale de l'Eclairage) Standard Observer response, to measure light received by the lens. Signals from the sensors are processed by a built-in microcomputer. Luminance data is displayed inside the viewfinder, and both luminance and chromaticity values are shown in the external display mounted on the side of the unit. The CS-100A can be used with optional close-up lenses, and is equipped with a data-output terminal for sending data to a separate computer (such as the Data Processor DP-101) or being remotely controlled.

Please read and study this manual before using the Chroma Meter CS-100A for first time, and keep it for future reference.

CONTENTS

	Page
Description	1
Contents	2
Names of parts	3
Functions of keys and switches	4
Displays and indications	5
Operation flow chart	7
Preparation	8
Installing battery	8
Selecting luminance unit	8
Eyepiece adjustment	9
Neutral-density eyepiece filter	9
Protective lens filter	9
Notes on using CS-100A	10
Measuring light-source chromaticity and subjective surface color	11
Calibration	11
PRESET calibration	11
VARI. calibration	11
Standardizing meters	13
Taking absolute measurements	14
Measuring color difference	14
Input of target color	15
Measuring target color	15
Setting target color data	16
Taking measurements	16
Target color data recall	17
Measuring surface chromaticity	18
Calibration	19
Measuring chromaticity	21
Measuring color difference	22
Input of target color	22
Measuring target color data	22
Storing reference color data	23
Taking measurements	24
Target color data recall	24
Measurements with close-up lenses	25
Calibration	25
Memory	28
Memory error	28
Clearing memory	28
Locking the focusing ring	29
Data output terminal	30
Use with Data Processor DP-101	30
Use with external power supply	30
Use with separate computer	31
Timing diagrams	32
CS-100A measuring system	36
Factory standard calibration procedure	38
Yxy color system	39
Care and storage	40
Technical details	41

NAMES OF PARTS

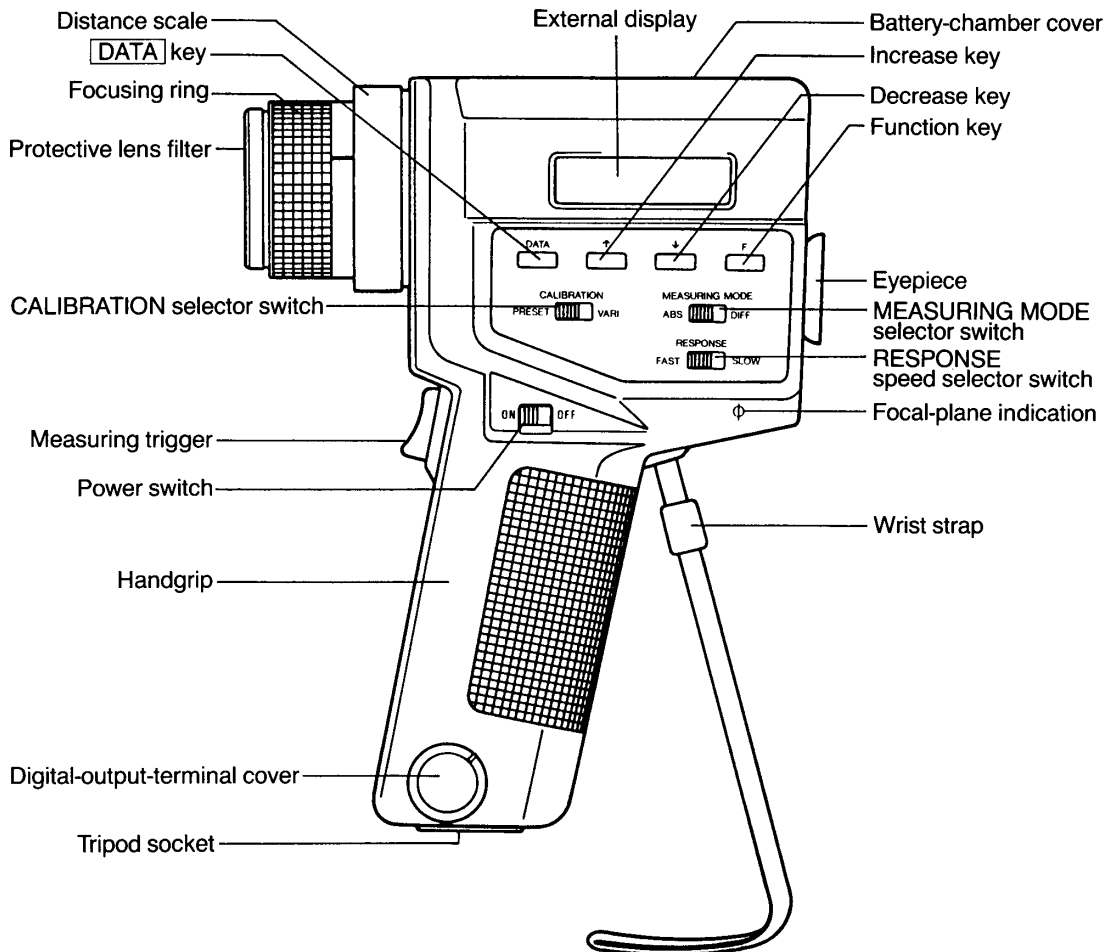
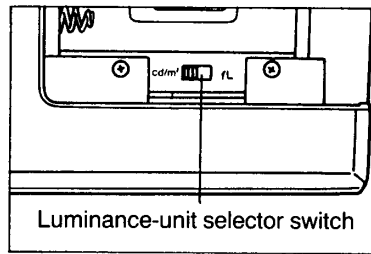

FUNCTION OF KEYS AND SWITCHES

Luminance-unit selector switch

Selects either cd/m² or fL luminance units.

MEASURING MODE selector switch

Selects either chromaticity or color-difference measuring mode: **ABS.** for chromaticity mode, **DIFF.** for color-difference mode.

Stores target color data in memory when moved from **ABS.** to **DIFF.** while **F** is held down.

CALIBRATION selector switch

Selects the calibration standard; **PRESET** for the factory standard, **VARI.** for user-selected reference subject.

Stores user-selected calibration data when moved from **PRESET** to **VARI.** while **F** is held down.

RESPONSE speed selector switch

Selects meter's response speed.

Set to **FAST** when metering under normal lighting conditions, including natural light, tungsten light, and fluorescent light. Set to **SLOW** when metering flickering light sources, including television screens, video monitors and projectors, cinema projectors, flashing LED lighting, and non-continuous light sources, and in low-luminance lighting.

F Function key

Releases the built-in safety lock (which prevents changing data accidentally). Must be held down while pressing other keys to perform their designated functions. Must also be held down when sliding switches to store data.

↑ Increase key

Increases the numerical value of displayed data when pressed while **F** is held down in data-setting mode; number increases by one each time key is pressed, and increases rapidly when the key is held down.

↓ Decrease key

Decreases the numerical value of displayed data when pressed while **F** is held down in data-setting mode; number decreases by one each time key is pressed and decreases rapidly when key is held down.

DATA Data key

Selects data to be displayed; cycles in the following order each time key is pressed:

Yxy → Y → x → y → Yxy → ...

Recalls user's calibration data from memory when MEASURING MODE selector switch is at **ABS.** and CALIBRATION selector switch is at **VARI.**

Recalls target color data from memory when MEASURING MODE selector switch is at **DIFF** and CALIBRATION selector switch is at **PRESET** or **VARI.**

Converts measured values between chromaticity and color-difference values when pressed while

F held down after changing setting of MEASURING MODE or CALIBRATION selector switch.

DISPLAYS AND INDICATIONS

Luminance Y and chromaticity x, y are displayed in the external display; luminance Y is displayed in the viewfinder. The viewfinder display will be automatically switched off about 5 sec. after the measuring trigger is released.

±0.0000 ±0.00 ±0.00
Yxy

External display

±0.00000

Viewfinder display

Measurement displays

Color measurement Yxy

2460 .444 .381

2460

Y (luminance) = 2460
x = 0.444
y = 0.381

299000 .440 .381

299000

Y (luminance) = 299,000
x = 0.440
y = 0.381

- When Y is from 100,000 to 999,000, the last two digits will blink in the external display.

Color-difference measurement $\pm \Delta(Yxy)$

+ 39 +0.023 -0.047

+ 39

$\Delta Y = +39$
 $\Delta x = +0.023$
 $\Delta y = -0.047$

Data recall

±18.6 ±348 ±298

±18.6

Error indications

b0

b0

Battery power is almost exhausted. Replace battery.

- If battery power is completely exhausted, no display will appear.

E0

E0

Luminance exceeds measuring range (over 299,000 cd/m² at **FAST** response speed, over 49,900 cd/m² at **SLOW** response speed).

79300 E0

79300

Luminance is within measuring range but tristimulus values X and/or Z are too high for chromaticity or color-difference measurements.

0.95 298 .301

0.95

Luminance is too low for chromaticity or color-difference measurements (below 48.0 cd/m² at **FAST** response speed or 11.9 cd/m² at **SLOW** response speed).

E9 .301 .428

E9

Incorrect calibration resulted in a measured Y value of over 999,000.

E

E

Recalculation was attempted before measurement was taken;

An attempt was made to enter E0, E9, or other data which cannot be stored as calibration data or as target color data for color-difference measurement; or

User calibration was attempted without measurement, or when the measured value of Y was 0 or set value of Y or y was 0.

E I

Stored target color or user calibration data was lost from memory. The memory must be cleared before proceeding.

CLE

Clear memory confirmation prompt (See page 32 for details.)

CAL

CAL

Recalculation is in progress or target color or user calibration data are being stored.

Y x y

Appears when the power switch is first slid to **ON** (will not appear if the power switch is slid to **ON** while the trigger is pressed);

The trigger was released before measured value was displayed; or

The memory has been cleared and is blank.

OPERATION FLOW CHART

Preparation

Insert battery.

Eyepiece adjustment

Set luminance unit.

Calibration

Factory standard (PRESET)

User standard (VARI)

Measurement

Measure chromaticity.

Take measurements.

Measure color difference.

Input target color.

Take measurements.

PREPARATION

Installing battery

1. Check that the power switch is at **OFF**.
2. Remove the battery-chamber cover by pressing down on it and sliding it in the direction of the arrow on the cover.

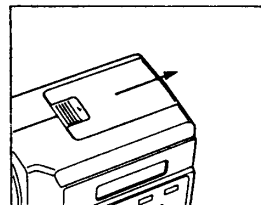

3. Install a 9V battery (Eveready 216 or equivalent) by positioning the battery terminals as illustrated inside the chamber and then inserting the battery, top (terminal) end first.

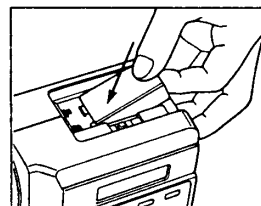

4. Replace the cover by realigning it and sliding it towards the meter body until it snaps securely into place.

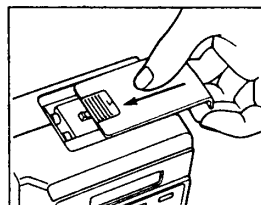

5. Slide the power switch to **ON**. If "Yxy" appears, the battery is OK. If "b0" or no display appears, the battery power is exhausted. Replace with a new battery.

NOTE: Chroma Meter CS-100A may also be used with an external power supply connected to the digital-output terminal. See page 30 for required connections.

Selecting luminance unit (cd/m² or fL)

1. Open the battery-chamber cover.

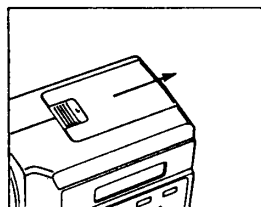

2. Adjust the luminance-unit selector switch to the desired setting.

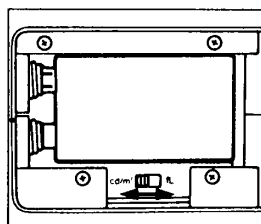

3. Replace the battery-chamber cover.

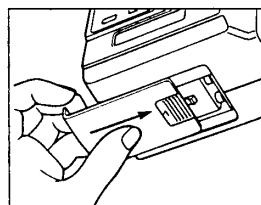

Eyepiece adjustment

Turn the eyepiece frame until the 1° measurement-area circle is sharp in the viewfinder (Adjustable diopter range: + 2.5 to - 3.75).

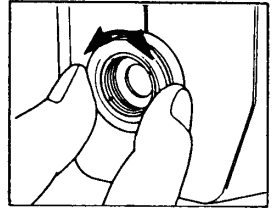

Neutral-density eyepiece filter

A neutral-density (ND) eyepiece filter is included with the CS-100A. This filter reduces the amount of light reaching the eye from the eyepiece and can be screwed into the eyepiece if desired. It is useful when subject brightness is so high that the measurement-area circuit or viewfinder display becomes difficult to see. The ND eyepiece filter does not affect measurements, so it may be left in the eyepiece at all times if desired.

Protective lens filter

Chroma Meter CS-100A should be calibrated and used with the protective lens filter in place. If the filter becomes soiled, use blower to remove loose dust, and wipe clean with a soft, dry cloth. If the filter is damaged, it should be replaced. Replacement filters are manufactured to a standard chromatic transmission density for measurement precision. When extremely precise data measurements are required, please contact the nearest Konica Minolta authorized service facility.

NOTES ON USING CS-100A

- When taking measurements, be sure that subject fills the measurement area. If subject does not fill measurement area, move closer (or use a close-up lens) and refocus. Measurements of subjects smaller than the measurement area will not be accurate.
- “Yxy” will appear and the measured values will not be displayed if the trigger is released before the readings are displayed.
- New measurements will be taken and the readings displayed every 1 second at **FAST** response speed and every 1.6 seconds at **SLOW** response speed if the trigger is held in.
- The viewfinder display will automatically be switched off approximately 5 seconds after the trigger is released.
- If subject luminance is low and the xy chromaticity indicator blinks during **FAST** response metering, or if the subject light is flickering or noncontinuous, change the response speed to **SLOW**.
- If CS-100A is mounted on a tripod for extended metering and there is a bright light source near the viewfinder, meter readings may be affected by this light source. Cover the eyepiece with the included eyepiece cap.
- The viewfinder display may be difficult to read during high luminance measurement. In such cases, insert the provided neutral-density (ND) filter into the eyepiece.
- The luminance (Y) of user’s calibration data and of the target color for color-difference measurement are stored as unitless numbers and are not converted when the position of luminance-unit selector switch is changed. When recalling user’s calibration or target color data, be sure to set the luminance-unit selector switch to the same position that it was at when the data was stored.
- If the CS-100A is being used to measure a CRT, do not place meter closer than 20cm from the CRT (as measured from the focal-plane indication).

MEASURING LIGHT-SOURCE CHROMATICITY AND SUBJECTIVE SURFACE COLOR

The CS-100A can be used to measure the chromaticity of light sources or the color of reflective surfaces under the lighting by which they will be viewed. To do this, follow the steps below.

- For chromaticity measurements of reflective surfaces, see page 18.

Calibration

The CALIBRATION selector switch of the CS-100A offers a choice of either **PRESET** or **VARI.** calibration.

PRESET CALIBRATION

The **PRESET** position of the CALIBRATION selector switch can be used when measuring most subjects. This position automatically calibrates the meter to the factory standard. (See page 38 for detail.)

VARI. CALIBRATION

The **VARI.** setting allows the user to calibrate the meter to any source desired. It should be used to calibrate the meter to another standard for which Yxy values are known, to precisely standardize several meters to the same standard, or for best accuracy when using a close-up lens. If the luminance (Y) value of calibration data is set to 100, displayed luminance values for measurements will be the ratio of the measured luminance to the standard luminance.

1. Slide the power switch to **ON**.

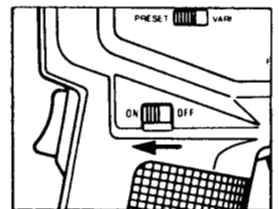

2. Set the CALIBRATION selector switch to **PRESET** and the MEASURING MODE selector switch to **ABS**. Check that RESPONSE speed and luminance-unit selector switches are at the desired positions.

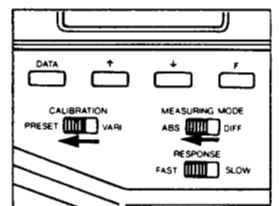

3. Aim the CS-100A at the reference subject and turn focusing ring until the subject appears sharp.

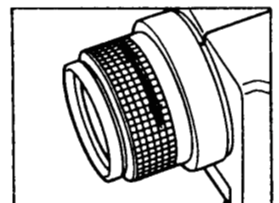

4. Pull the measuring trigger and hold it in until the luminance value (Y) appears in the viewfinder display. Yxy values will appear in the external display.

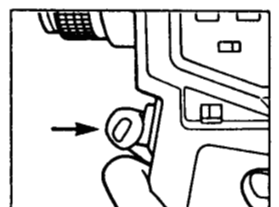

CAUTION:

Steps 5 through 7 offer the easiest and fastest setting of calibration data. However, these steps store a value in the target memory and thus erase any previously stored target color data for color-difference mode. If it is necessary to keep the previously stored target color data, slide CALIBRATION selector switch from **PRESET** to **VARI.**, press **DATA** and go to step 8.

5. Store the value measured in step 3 by pressing and holding **[F]** and sliding the MEASURING MODE selector switch to **DIFF**.

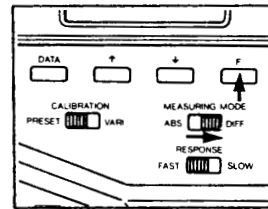

6. Press **[DATA]**. "±" will appear before each figure.

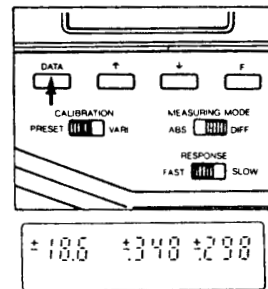

7. Slide the MEASURING MODE selector switch to **ABS**.

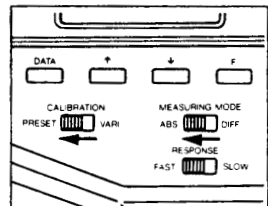

8. Press **[DATA]** again. Only the value for Y will appear in the external display.

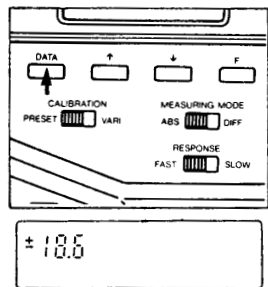

Set Y by pressing and holding **[F]** and pressing either **[↑]** or **[↓]** until the displayed value matches the desired value.

- Y value may be set between 0.01 and 999000. Only the three highest-order digits may be changed in step 7; the remaining digits will be 0.

9. Repeat step 7 to set x value (0.000 to 0.999) and again to set y value (0.001 to 0.999)

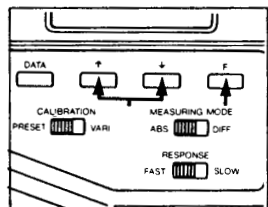

10. Press **DATA**. The values set for Yxy will appear in the display.

* The data-setting cycle will start over if **DATA** is pressed again.

* Steps 7 through 9 are not necessary if the displayed values are equal to the desired values.

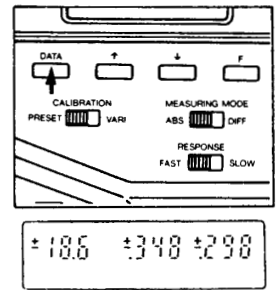

11. To store the values for Yxy in memory and complete calibration, slide the CALIBRATION selector switch from **VARI** to **PRESET** (if not already at **PRESET**), press and hold **F**, then slide the switch back to **VARI**.

The external display will read "CAL" for a moment as the Yxy values are stored and the meter automatically adjusts its calibration. It will then revert to the Yxy values. Calibration is now complete. The stored calibration data will remain in memory until changed or cleared by the user.

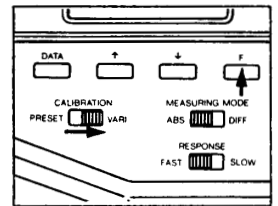

VARI. calibration data recall

To check user's calibration data in memory:

1. Set the CALIBRATION selector switch to **VARI** and the MEASURING MODE selector switch to **ABS**.

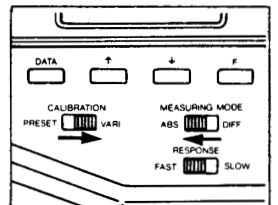

2. Press **DATA**. The previously stored calibration data for the user's standard will appear in the display. "±" will appear before each figure.

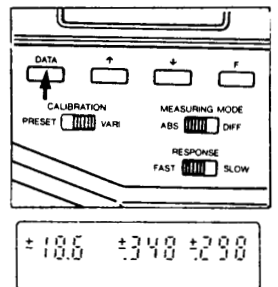

Standardizing meters

To standardize several meters, calibrate all meters to the same reference. For best results, the color of the reference should be close to that of the subjects to be measured. Select one meter as the master, measure the standard with this meter, and set all meters to this calibration data following the procedures in the preceding **VARI. CALIBRATION** section.

Taking absolute measurements

1. Slide the power switch to **ON**.

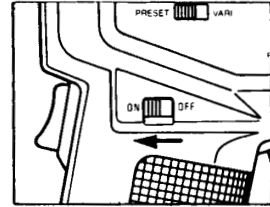

2. Set the MEASURING MODE selector switch to **ABS.** and check that the CALIBRATION, RESPONSE speed, and luminance-unit selector switches are set to the desired positions.

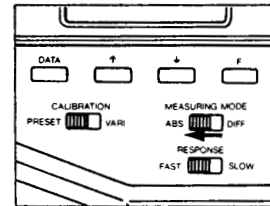

3. Aim the CS-100A at the subject and turn the focusing ring until the subject appears sharp.

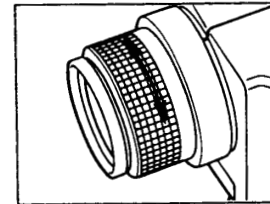

4. Pull the measuring trigger and hold it in until the luminance value (Y) appears in the viewfinder display (approximately 2 seconds at **FAST** response speed and 4 seconds at **SLOW** response speed). Yxy values will appear in the external display.

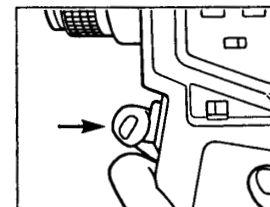

Measuring color difference

The color-difference measuring mode may be used for determining the difference between a stored set of target values and a measured color. In order to measure color difference, values for a target color must first be stored in memory. If a suitable target subject is available, it can be measured by following the procedure below. If the Yxy values of the desired target color are known and no suitable subject is available, slide power switch to **ON**, set the MEASURING MODE selector switch to **DIFF.**, press **DATA**, and start at step 5 below.

- When measuring reflective surfaces, the measured color will depend on both the actual color of the surface and the lighting conditions under which the surface is measured. Therefore, the target surface and sample surfaces should be measured under the same conditions when determining color difference. If the Yxy values of the target color are being set directly, be sure the target values were obtained using the conditions under which samples will be measured.

INPUT OF TARGET COLOR

Measuring target color

1. Slide the power switch to **ON**.

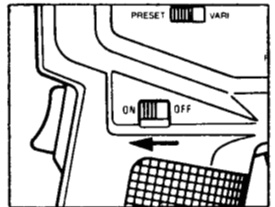

2. Set the MEASURING MODE selector switch to **ABS** and check that CALIBRATION, RESPONSE speed, and luminance-unit selector switches are at the desired positions.

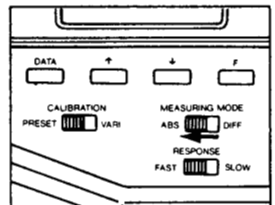

3. Aim the CS-100A at the subject and turn the focusing ring until the subject appears sharp.

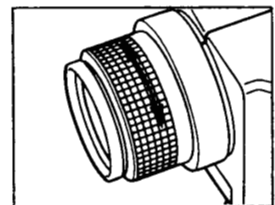

4. Pull the measuring trigger and hold it in until the luminance value (Y) appears in the viewfinder display. Xy values will appear in the external display.

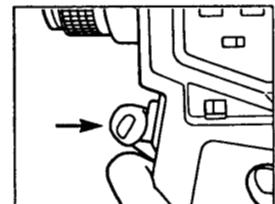

5. Store the values measured in step 4 by pressing and holding **F** and sliding the MEASURING MODE selector switch to **DIFF**. The external display will read "CAL" for a moment as the target values are stored, then revert to the previous display. The stored data will remain in memory until changed or cleared by user.

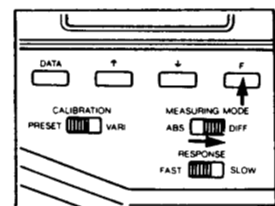

Press and hold **[F]** and press **[DATA]**. To indicate that the data has been correctly stored, the display will show all values as zero.

The meter is now ready to measure color difference based on the measured subject by following the procedure in TAKING MEASUREMENTS below.

- If it is desired to adjust these measured values, press **[DATA]** and continue with step 6 below.

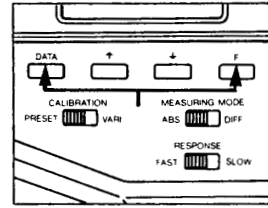

Setting target color data

6. Press **[DATA]** again. Only the value for Y will appear in the display.

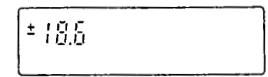
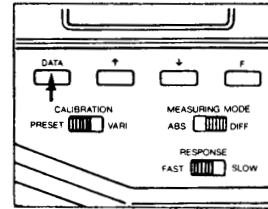

Set Y by pressing and holding **[F]** and pressing either **[↑]** or **[↓]** until the displayed value is equal to the desired value.

- Y value may be set between 0.00 and 999000. Only the three highest-order digits may be changed in step 6; the remaining digits will be 0.

7. Repeat step 6 to set x value (0.000 to 0.999) and again to set y value (0.001 to 0.999).

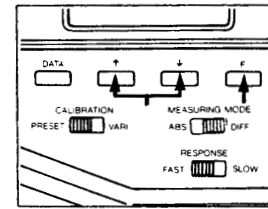

8. Press **[DATA]**. The values set for Yxy will appear in the external display.

- The data-setting cycle will start over if **[DATA]** is pressed again.

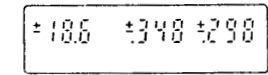
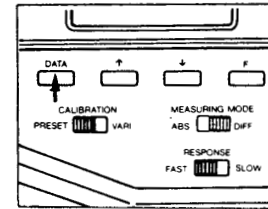

9. To store the values set for Yxy, slide the MEASURING MODE selector switch from **DIFF.** to **ABS.** Press and hold **[F]**, and slide the switch back to **DIFF.** The external display will read "CAL" for a moment as the target values are stored, then revert to the previous display. The stored data will remain in memory until changed or cleared by user.

The meter is now ready to measure color difference by following the procedure below.

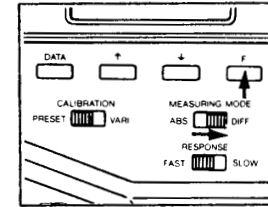

TAKING MEASUREMENTS

1. Slide the power switch to **ON.**

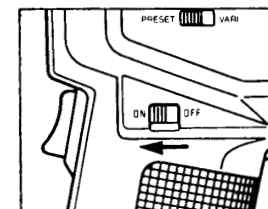

- Set the MEASURING MODE selector switch to **DIFF.** and check that the CALIBRATION, RESPONSE speed, and luminance-unit selector switches are at the desired positions.

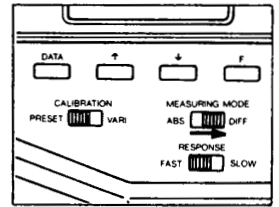

- Aim the CS-100A at the subject and turn the focusing ring until the subject appears sharp.

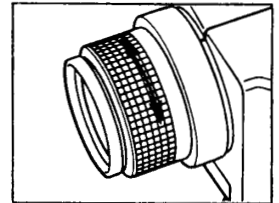

- Pull the measuring trigger and hold it in until the luminance value (Y) appears in the viewfinder display. Yxy values will appear in the external display.
 - After measuring color difference, the measurement on display can be converted to a chromaticity measurement by sliding the MEASURING MODE selector switch to **ABS.**, pressing and holding **[F]**, and pressing **[DATA]**.

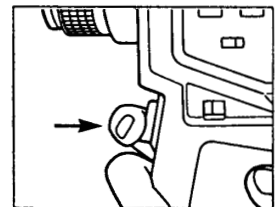

TARGET COLOR DATA RECALL

To check the target color data in memory:

- Set the MEASURING MODE selector switch to **DIFF.**

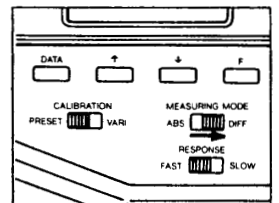

- Press **[DATA]**. The stored target color data will appear in the external display. “±” will appear before each figure.

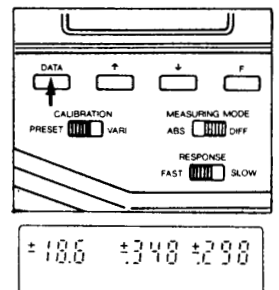

MEASURING SURFACE CHROMATICITY

Surface color is measured by measuring the color of light reflected from that surface. The color of the reflected light depends on both the color of the light source used and the reflectance of the surface being measured. The procedure on pages 12 through 19 can be used to measure the subjective color or color difference of a surface (the color or color difference of a surface under the lighting by which it will be viewed). The CS-100A can also be used to measure the chromaticity or color difference of a surface (the color or color difference of a surface under standard lighting conditions). Two different lighting methods may be used for measuring surface chromaticity or color difference.

Direct artificial lighting, filtered to closely match CIE Standard Illuminant A (2856), C (6774K), or D_{65} (6504K), may be used to provide illumination. The lamps should be placed at a 45° angle to the surface, as shown in figure A. The CS-100A should be positioned so that its optical axis (drawn through the center of its objective lens) is perpendicular to the surface. This arrangement closely matches the standard 45/0 geometry used for color measurements.

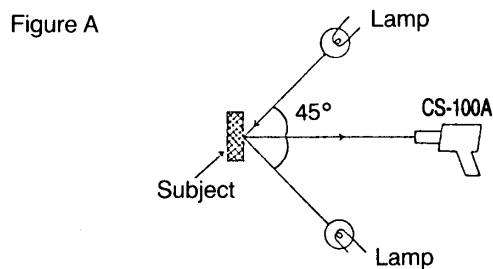

Diffuse lighting which closely matches CIE Standard Illuminant C (6774K) or D_{65} (6504K), such as in open shade or sunlight on an overcast day, may also be used for illumination. In this situation, shown in figure B, the CS-100 should have its optical axis perpendicular to the surface. This arrangement results in a $d/0$ (specular component included) measurement geometry.

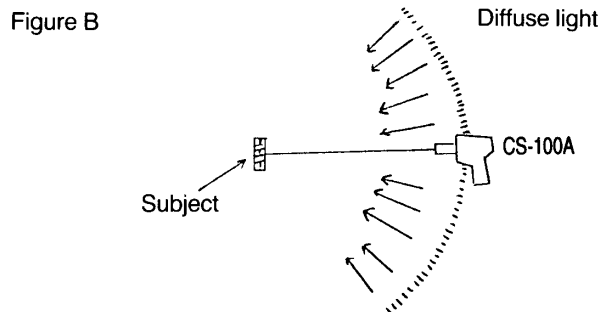

- When using natural lighting for chromaticity measurements, the CS-100A should be calibrated immediately before taking measurements since the color of natural lighting is constantly changing.
- A light source which more closely matches the desired CIE Standard Illuminant will provide more accurate measurements.

Calibration

It is necessary to calibrate the meter to a subject of known chromaticity and reflectance under the exact same lighting conditions that will be used during measurement. White Calibration Plates are sold separately for this purpose. Be sure to use the white plate intended for the measurement geometry being used (White Calibration Plate CS-A20 for 45/0, CS-A21 for d/0).

To calibrate the CS-100A to the light source and measurement geometry being used, follow the procedures below.

1. Slide the power switch to **ON**.
2. Position the standard white plate at the subject location, as shown in figure A or B, according to the measurement geometry being used.

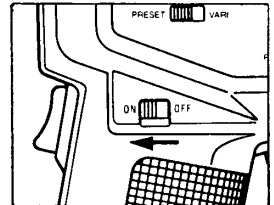

3. Set the CALIBRATION selector switch to **PRESET** and the MEASURING MODE selector switch to **ABS**. Check that RESPONSE speed and luminance-unit selector switches are at the desired positions.

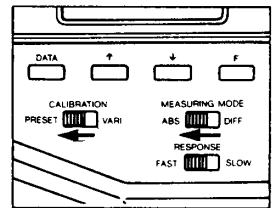

4. Aim the CS-100A at the white calibration plate and turn the focusing ring until the plate appears sharp.

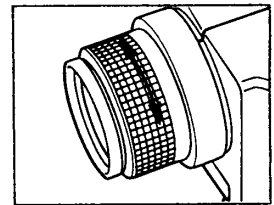

5. Pull the measuring trigger and hold it in until the luminance value (Y) appears in the viewfinder display. Yxy values will appear in the external display.

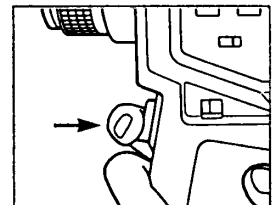

CAUTION:

Steps 6 through 8 offer the easiest and fastest setting of data. However, these steps store a value in the target memory and thus erase any previously stored target color data for color-difference mode. If it is necessary to keep the previously stored target color data, slide the CALIBRATION selector switch from **PRESET** to **VARI.**, press **DATA** and go to step 9 below.

6. Store the value measured in step 5 by pressing and holding **F** and sliding the MEASURING MODE selector switch to **DIFF**.

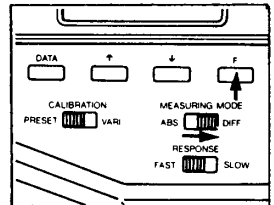

7. Press **DATA**. “±” will appear before each figure.

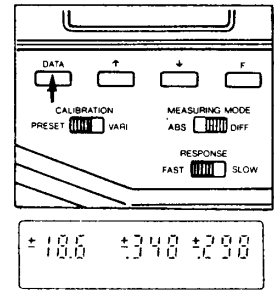

8. Slide the MEASURING MODE selector switch to **ABS**.

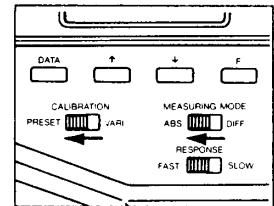

9. Press **DATA** again. Only the value for Y will appear in the external display.

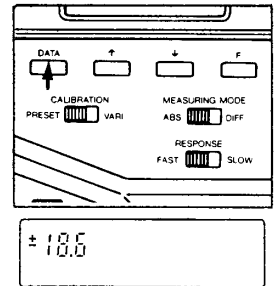

Set Y by pressing and holding **F** and pressing either **↑** or **↓** until the displayed value matches the standard value for the white plate being used. Values for CIE Standard Illuminants A, C, and D₆₅ are listed on the inside cover of White Calibration Plate CS-A20; values for CIE Standard Illuminant C and D₆₅ are listed on the inside cover of White Calibration Plate CS-A21.

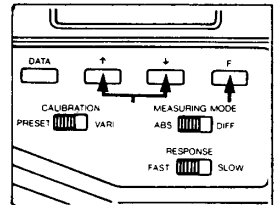

10. Repeat step 9 to set the x value and again to set the y value.

11. Press **DATA**. The values set for Yxy will appear in the external display.

- The data-setting cycle will start over if **DATA** is pressed again.

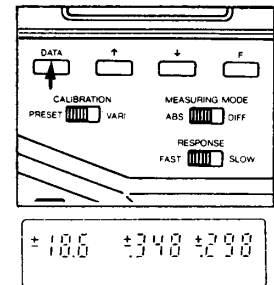

- To store the values for Yxy in memory and complete calibration, slide the CALIBRATION selector switch from **VARI.** to **PRESET** (if not already set at **PRESET**), press and hold **[F]**, then slide the switch back to **VARI.** The display will read “CAL” for a moment as the Yxy values are stored and the meter automatically adjusts its calibration, then revert to the Yxy values. Calibration is now complete. The stored calibration data will remain in memory until changed or cleared by the user.

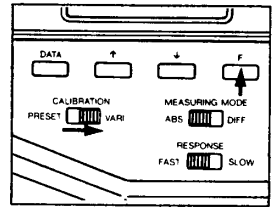

CALIBRATION DATA RECALL

To check calibration data in memory:

- Set the CALIBRATION selector switch to **VARI.** and the MEASURING MODE selector switch to **ABS.**

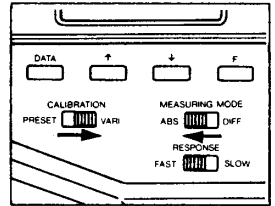

- Press **[DATA]**. The previously stored calibration data for user's standard will appear in the external display. “±” will appear before each figure.

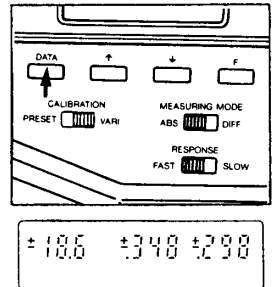

Measuring chromaticity

- Position the subject under the same lighting conditions and in the exact location and orientation that the white calibration plate was in for calibration. Other lighting conditions, locations or orientations may cause errors in measurement.
- Set the MEASURING MODE selector switch to **ABS.** and check that the RESPONSE speed and luminance-unit selector switches are set to the desired positions and the CALIBRATION selector switch is set to **VARI.**

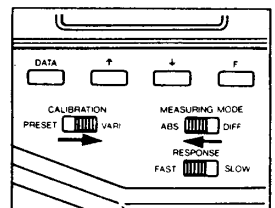

- Aim the CS-100A at the subject and turn the focusing ring until the subject appears sharp.

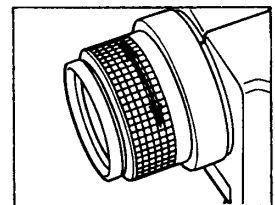

- Pull the measuring trigger and hold it in until a luminance value (Y) appears in the viewfinder display (approximately two seconds at **FAST** response speed, four seconds at **SLOW** response speed). Y (luminance) and xy (chromaticity coordinates) values will appear in the external display.

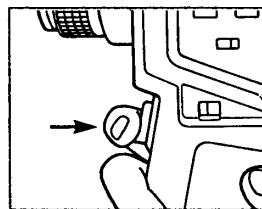

Measuring color difference

The color-difference measuring mode may be used for determining the difference between a stored set of reference values and a measured color. In order to measure color difference, values for a target color must first be stored in memory. If a suitable target subject is available, it can be measured by following the procedure below. If the Yxy values of the desired target color are known and no suitable subject is available, be sure the CALIBRATION selector switch is set to **VARI.**, the MEASURING MODE selector switch is at **DIFF.**, and the RESPONSE speed and luminance-unit selector switches are at the desired positions, press [DATA], and start at step 6 below.

INPUT OF TARGET COLOR

Measuring target color

- Position the subject under the same lighting conditions and in the exact location and orientation that the white calibration plate was in for calibration. Other lighting conditions, locations, or orientations may cause errors in measurement.
- Set the MEASURING MODE selector to **ABS.** and check that the CALIBRATION selector switch is set to **VARI.** and the RESPONSE speed and luminance-unit selector switches are at the desired positions.

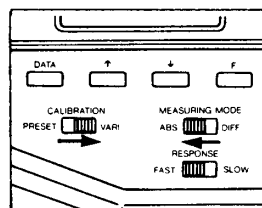

- Aim the CS-100A at the subject and turn the focusing ring until the subject appears sharp.

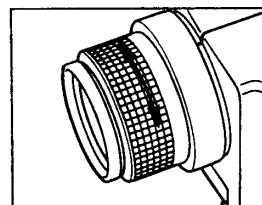

- Pull the measuring trigger and hold it in until the luminance value (Y) appears in the viewfinder display. Yxy values will appear in the external display.

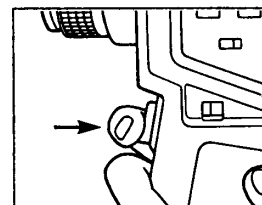

- Store the values measured in step 4 by pressing and holding [F] and sliding the MEASURING MODE selector switch to **DIFF.**

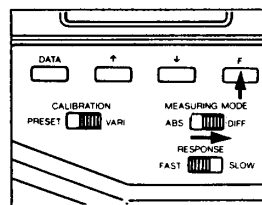

Press and hold **[F]** and press **[DATA]**. To indicate that the data has been correctly stored, the display will show all values as zero.

The meter is now ready to measure color difference based on the measured subject by following the procedure in **TAKING MEASUREMENTS** below.

- If it is desired to adjust these measured values, press **[DATA]** and continue with step 6 below.

Setting target color data

6. Press **[DATA]** again. Only the value for Y will appear in the external display.

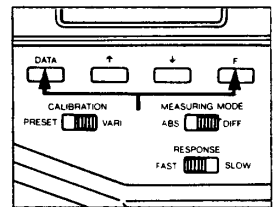

Set Y by pressing and holding **[F]** and pressing either **[↑]** or **[↓]** until the displayed value is equal to the desired value.

- Y may be set between 0.00 and 999000. Only the three highest-order digits may be changed in step 6; the remaining digits will be 0.
7. Repeat step 6 to set the x value (0.000 to 0.999) and again to set y value (0.001 to 0.999).

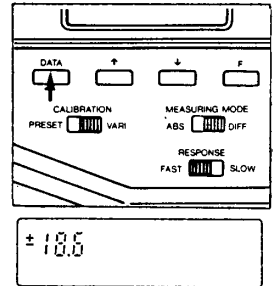

8. Press **[DATA]**. The values set for Yxy will appear in the external display.

- The data-setting cycle will start over if **[DATA]** is pressed again.

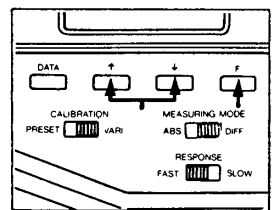

9. To store the values set for Yxy, slide the **MEASURING MODE** selector switch from **DIFF.** to **ABS.** Press and hold **[F]**, and slide the switch back to **DIFF.** The display will read “CAL” for a moment as the reference values are stored, then revert to the previous display. The stores data will remain in memory until cleared or changed by user.

The meter is now ready to measure color difference by following the procedure below.

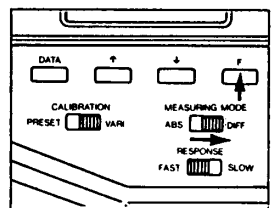
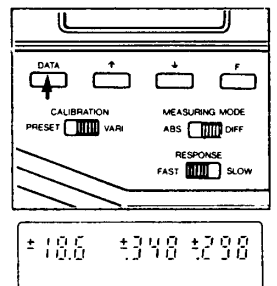

TAKING MEASUREMENTS

1. Position the subject under the same lighting conditions and in the exact location and orientation used for measuring the reference subject. Differences in lighting conditions, location, or orientation may cause errors in measurement.
2. Set the MEASURING MODE selector to **DIFF.** and check that the CALIBRATION selector switch is set the **VARI.** and the RESPONSE speed and luminance-unit selector switches are at the desired positions.

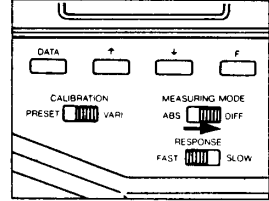

3. Aim the CS-100A at the subject and turn the focusing ring until the subject appears sharp.

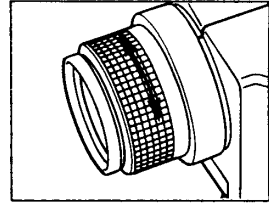

4. Pull the measuring trigger and hold it in until the luminance value (Y) appears in the viewfinder display. Yxy values will appear in the external display.

- After measuring color difference, the values in the external display can be converted to chromaticity values by sliding the MEASURING MODE selector switch to **ABS.**, pressing and holding **[F]**, and pushing **[DATA]**.

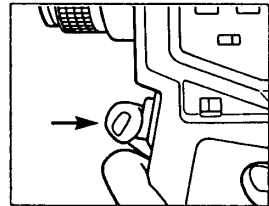

TARGET COLOR DATA RECALL

To check the target color data in memory:

1. Set the MEASURING MODE selector switch to **DIFF.**

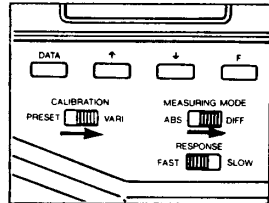

2. Press **[DATA]**. The stored target color data will appear in the external display. "±" will appear before each figure.

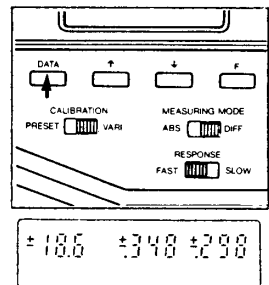

MEASUREMENTS WITH CLOSE-UP LENSES

Optional close-up lenses may be attached to the CS-100A for taking color measurements of small subjects at short distances. With no close-up lens, the CS-100A can measure subjects as close as 1014mm from the focal-plane indication, with a minimum measuring area of 14.4mm in diameter. By using one of the optional close-up lenses, measurements may be taken down to 205mm from the measurement plane, with a measuring area of only 1.3mm in diameter. Only one close-up lens at a time may be attached to the CS-100A. Further details are shown in the chart below.

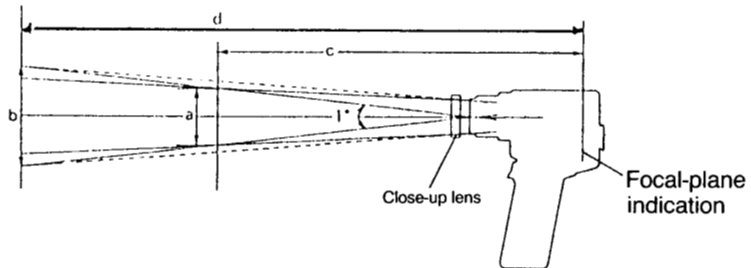

Close-up lens	mm	(a) Measuring diameter at minimum measuring distance	(b) Measuring diameter at maximum measuring distance	(c) Minimum measuring distance	(d) Maximum measuring distance
None		φ 14.4	—	1014	∞
No. 153		φ 8.0	φ 18.7	617	1209
No. 135		φ 5.2	φ 8.7	450	621
No. 122		φ 3.2	φ 4.3	326	373
No. 110		φ 1.3	φ 1.5	209	211

*Theoretical values

The spectral transmissions of the protective lens filter and close-up lenses are approximately equal. However, since the spectral transmissions are not exactly the same, when extremely precise measurements are desired, the CS-100A should be recalibrated to the spectral transmission of the close-up lens being used. To do this, follow the steps below.

Calibration

1. Check that the protective lens filter is in place.
2. Set the CALIBRATION selector switch to the desired position (**PRESET** or **VARI.**) and the MEASURING MODE selector switch to **ABS.** Check that the RESPONSE speed and luminance-unit selector switches are at the desired positions.

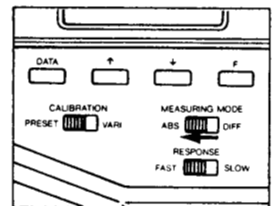

3. Aim the CS-100A at a subject of uniform luminance and chromaticity and turn the focusing ring until the subject appears sharp.

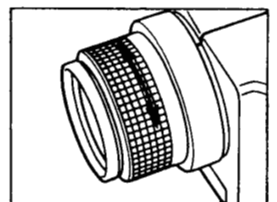

4. Pull the measuring trigger and hold it in until the luminance value (Y) appears in the viewfinder display. Yxy values will appear in the external display.

CAUTION:

Steps 5 through 8 offer the easiest and fastest setting of data. However, these steps store a value in the target memory and thus erase any previously stored target color data for the color-difference mode. If it is necessary to keep the previously stored target color data, press **DATA** and go to step 9.

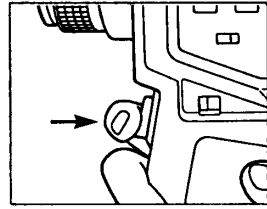

5. Store the value measured in step 4 by pressing and holding **F** and sliding the MEASURING MODE selector switch to **DIFF**.

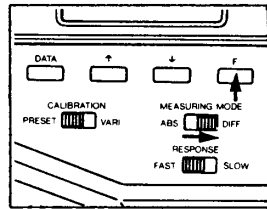

6. Press **DATA**. "±" will appear before each figure.

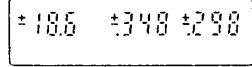
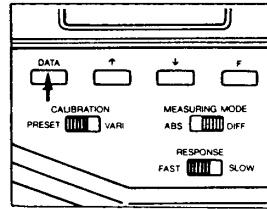

7. Slide the MEASURING MODE selector switch to **ABS**.
8. Go to step 11 below.

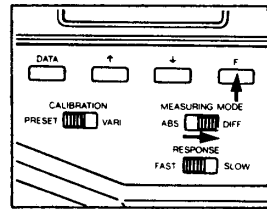

9. Press **DATA** again. Only the value for Y will appear in the external display.

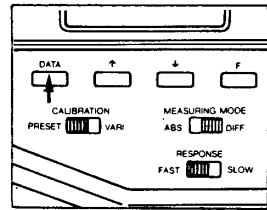

Set Y value (0.01 to 999000) by pressing and holding **F** and pressing either **↑** or **↓** until the displayed value matches the value displayed in step 4.

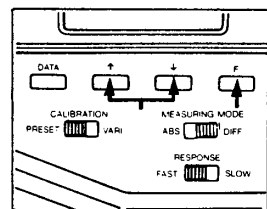

10. Repeat step 9 to set the x value (0.000 to 0.999) and again to set the y value (0.001 to 0.999).
11. Press **[DATA]**. The values set for Yxy will appear in the external display.
 - The data-setting cycle will start over if **[DATA]** is pressed again.

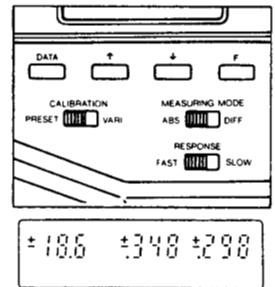

12. To store the values for Yxy in memory and complete calibration, slide the CALIBRATION selector switch from **VARI** to **PRESET** (if not set to **PRESET** in step 2), press and hold **[F]**, then slide the switch back to **VARI**. The external display will read "CAL" for a moment as the Yxy values are stored and the meter automatically adjusts its calibration, then the display will revert to the Yxy values.

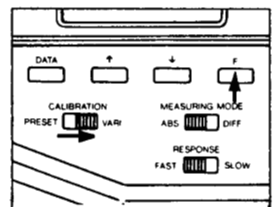

13. Replace the protective lens filter with the desired close-up lens.

14. Aim the CS-100A at the subject used in step 3 and turn the focusing ring until the subject appears sharp.

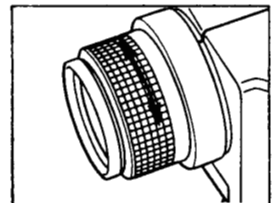

15. Pull the measuring trigger and hold it in until the luminance value (Y) appears in the viewfinder display. Yxy values will appear in the external display.

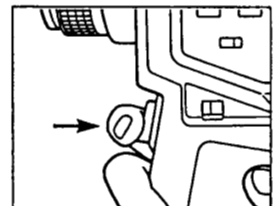

16. Press **[DATA]**. The previously stored calibration data will appear in the display. "±" will appear before each figure.

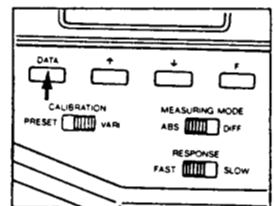

17. Slide the CALIBRATION selector switch from **VARI** to **PRESET**, press and hold **[F]**, then slide the switch back to **VARI**. The external display will read "CAL" for a moment as the Yxy values are stored and the meter automatically adjusts its calibration, then the external display revert to the Yxy values.

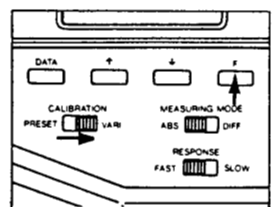

The CS-100A is now ready to take color measurements with the close-up lens.

Memory error

If a memory malfunction occurs and the stored target color data or user's calibration data are lost, "E1" will be indicated in the display when the power is switched **ON**.

If this display appears, the memory must be cleared before continuing.

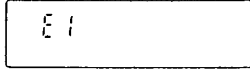



Memory error may occur if the power is switched off while "CAL" is displayed while storing target color data or user's standard calibration data.

Memory

User's calibration data and target color data for color-difference measurements are retained until other data is entered in the memory. Data remains in memory even when the power is switched **OFF**, the battery is replaced, or the power cord is disconnected during use with an external power source.

Clearing memory

Follow the procedure below to clear current target color data and user's calibration data. If a memory error has occurred, start with step 2.

Press and hold both  and  while sliding the power switch to **ON**. "CLE" will appear in the display.

- If it is decided not to clear the memory, either press the measuring trigger or switch the power **OFF** to cancel the clear procedure.

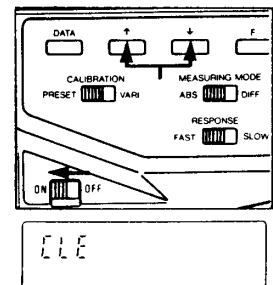

2. While pressing , slide the CALIBRATION selector switch from **PRESET** to **VARI**. "Yxy" will appear in the external display. All values of target color and user's calibration data will be set to 0 and measurements taken at **PRESET** and **VARI**. calibration setting will be equal.

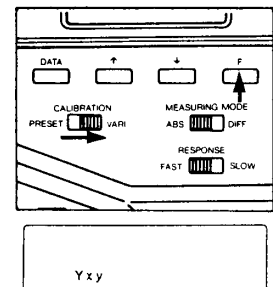

LOCKING THE FOCUSING RING

The focusing ring can be locked to prevent focus from shifting when CS-100A is set up for taking several measurements without refocusing.

1. Use an M3 screw at least 5mm long.
2. Insert the screw into the focusing-ring lock hole and tighten until snug. Do not overtighten.

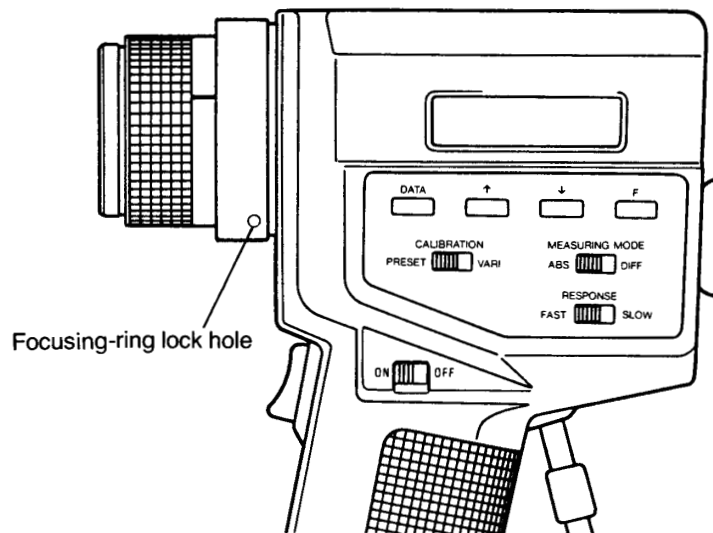

DATA OUTPUT TERMINAL

CS-100A is the model that RS-232C communication function was added to while succeeding to the data output function of CS-100.

- About RS-232C communication function, please refer to the CS-100A communication manual.
- About the data output function of the CS-100, please refer to P30-P36 of this manual.

The CS-100A is equipped with a data-output terminal which may be used for connection with the Data Processor DP-101, for supplying power from an external power supply, or for connection with a separate computer.

The data-output terminal is a Hirose RP17-13RA-12SD connector. A Hirose RP17-13P-12PC or other compatible connector should be used on the data-output cord. The wiring and connections of the output terminal (See P.1 of the CS-100A communication manual).

Use with Data Processor DP-101

The CS-100A and Data Processor DP-101 may be easily connected together using the Data Cable supplied with the DP-101. When the CS-100A is connected with the DP-101, several additional functions are available. Color systems $Y_u'v'$ and $L^*a^*b^*$ (CIE 1976) may be used for chromaticity and color-difference measurements; total color difference ΔE^*_{ab} , color temperature, and color distance from blackbody by uv may also be determined. Up to 300 data sets, four calibration standards, and 17 target colors (for color-difference measurements) may be stored in memory. Data printout and statistical calculations may also be performed. Other features include a built-in timer for taking measurements at user-selected intervals and a multiple-measurement mode which automatically takes three measurements, averages them, and uses the average as the data set.

For further information about the Data Processor DP-101, contact the nearest Konica Minolta authorized service facility.

Use with external power supply

To use the data-output terminal for supplying power to the CS-100A from an external source, connect the positive lead of an 8 to 12V, 100mA power supply to pin 5 and the negative or ground lead of the power supply to pins 1 and 2.

Use with separate computer

The CS-100A may be connected to a separate computer via the data-output terminal if desired. Information regarding data format and signal functions are shown below.

One data word is 16 bits: an 8-bit preliminary signal (4 high bits, 3 low bits, 1 high bit) followed by the 8-bit data signal (See table on page 34). There are 15 data words per measurement data set. The end of a data set is signalled by 1 high bit and 7 low bits.

Data output is started by releasing the measuring trigger after measurement or by changing the measurement-request signal from high to low. The power switch of the CS-100A must be set to **ON** when using the measurement request signal to control the meter; the meter's external display will be on, but the viewfinder display will be off.

Although the data displayed by the CS-100A shows only 3 significant figures, output data has 4 significant figures.

	Y	x	y
Stored data	10.79	.3346	.3021
Displayed data	10.7	.334	.302

The final digit for each value of output or stored data is not included in the display. The output data range and Y display range when the CALIBRATION selector switch is at **PRESET** and the MEASURING MODE selector switch is at **ABS.** are shown below.

RESPONSE speed	Luminance unit	Displayed range	Output range
FAST	cd/m^2	0.00 ~ 299000	0.000 ~ 299900
FAST	f L	0.00 ~ 87500	0.000 ~ 87540
SLOW	cd/m^2	0.00 ~ 49900	0.000 ~ 49990
SLOW	f L	0.00 ~ 14500	0.000 ~ 14590

If the busy signal is high, data is output when measurement-request signal is low while the trigger is released, or when the measurement-request signal changes from high to low while the trigger is not pulled in. There is no priority for either signal; if the trigger is being held in when the measurement-request signal changes from high to low, or if the measurement-request signal is high when the trigger is released, data is not output. Also, data will not be output if busy signal is low.

- If the trigger is released before data appears in the displays (less than 2 sec. at **FAST** response speed or 4 sec. at **SLOW** response speed), data will not be output.
- When the measurement-request signal is low, the delay to data output after the trigger is released is up to 0.2 sec. at **FAST** response speed and up to 0.4 sec. at **SLOW** response speed.
- The measurement-request signal must be held high for at least 100msec before changing to low.
- When the trigger is not pulled in, the delay to data output after the measurement-request signal switches from high to low is up to 2 sec. at **FAST** response speed and up to 4 sec. at **SLOW** response speed.
- If the measurement-request signal has been held high for longer than 2 seconds at **FAST** response speed or 4 seconds at **SLOW** response speed, the delay to data output after the signal switches from high to low is up to 0.2 sec. at **FAST** response speed or 0.4 seconds at **SLOW** response speed.
- When measurements are made with the measurement-request signal, the external display comes on but the viewfinder display does not.

TIMING DIAGRAMS

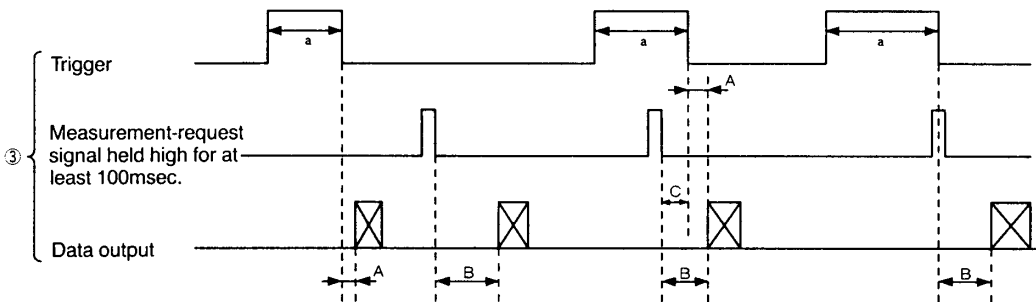
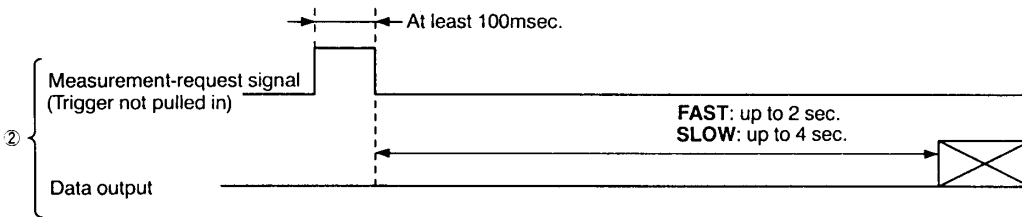
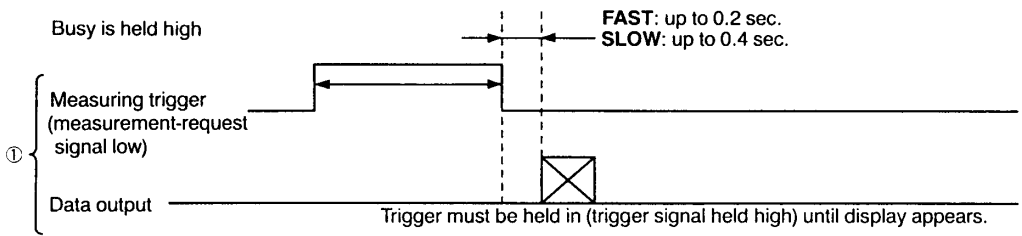

	A	B
FAST	Up to 0.2 sec.	Up to 2 sec.
SLOW	Up to 0.4 sec.	Up to 4 sec.

However, when $C \geq 2$ sec. (FAST), or 4 sec. (SLOW): A
when $C \leq 2$ sec. (FAST), or 4 sec. (SLOW): B

Data Output

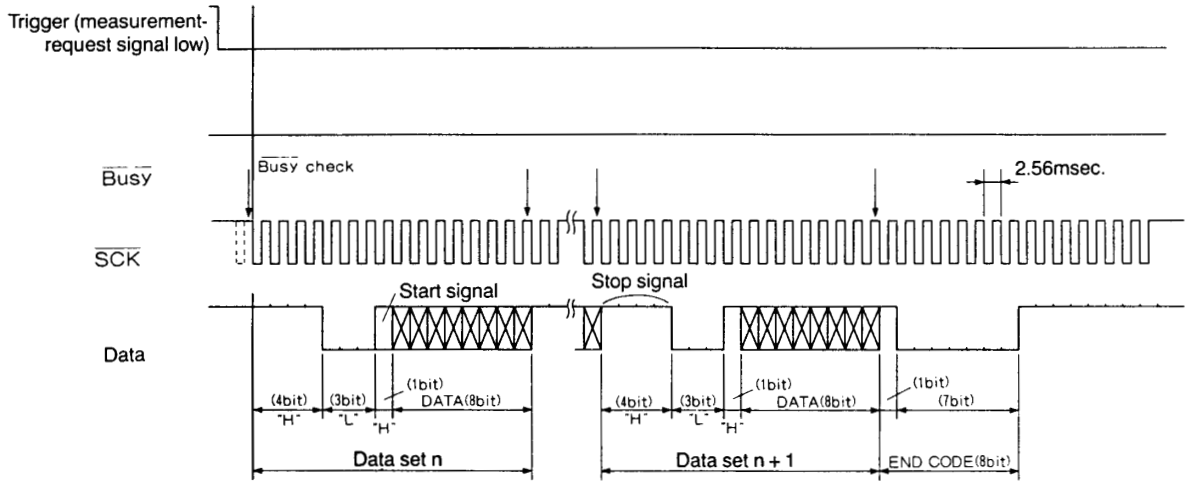

Operation with busy signal

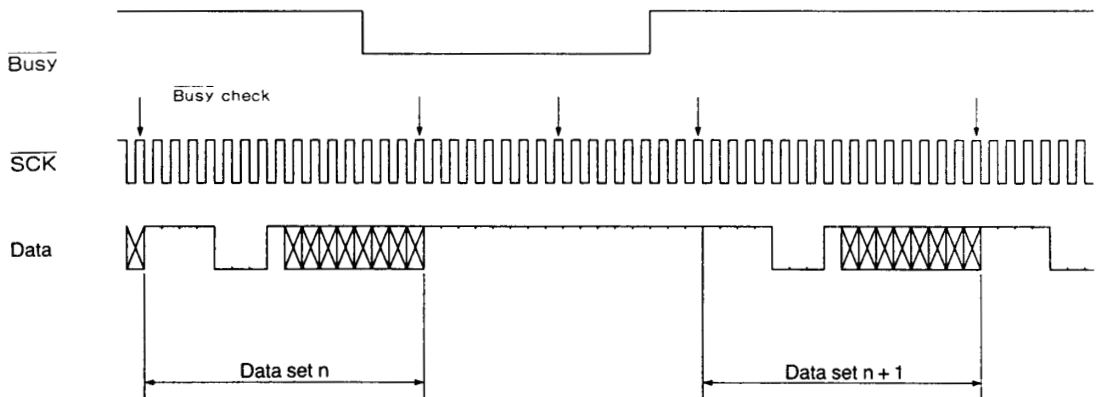

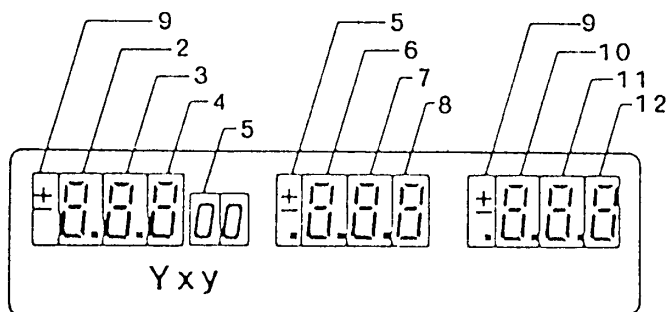

Data-Output Table

Data set	Contents	Data (8 bits)								Comments
1		1	1	1	1	1	1	1	1	
2	Y (first digit)									See Number Code Table.
3	Y (second digit)									See Number Code Table.
4	Y (third digit)									See Number Code Table.
5	Y multiplier (lower 4 bits)	-	-	-	-	1	1	1	1	Y × 1; "0" not displayed
		-	-	-	-	1	1	0	1	Y × 10 "0"
		-	-	-	-	1	0	0	1	Y × 100 "00"
		-	-	-	-	0	0	0	1	Y × 1000; "00" blinking in display
	sign for x (bits 4 through 6)	-	-	1	1	-	-	-	-	Blank
		-	-	0	1	-	-	-	-	-
		-	-	1	0	-	-	-	-	+
		-	-	0	0	-	-	-	-	±
		-	1	-	-	-	-	-	-	no decimal point displayed
		-	0	-	-	-	-	-	-	decimal point displayed
chromaticity range (bit 7)	0	-	-	-	-	-	-	-	Outside range	
	1	-	-	-	-	-	-	-	Within range	
6	x (first digit)									See Number Code Table.
7	x (second digit)									See Number Code Table.
8	x (third digit)									See Number Code Table.
9	sign for Y (lower 4 bits)	-	-	-	-	-	-	1	1	Blank
		-	-	-	-	-	-	0	1	-
		-	-	-	-	-	-	1	0	+
		-	-	-	-	-	-	0	0	±
	sign for y (upper 4 bits)	-	-	1	1	-	-	-	-	Blank
		-	-	0	1	-	-	-	-	-
		-	-	1	0	-	-	-	-	+
		-	-	0	0	-	-	-	-	±
		-	1	-	-	-	-	-	-	no decimal point displayed
		-	0	-	-	-	-	-	-	decimal point displayed
10	y (first digit)									See Number Code Table.
11	y (second digit)									See Number Code Table.
12	y (third digit)									See Number Code Table.
13	Y (fourth digit)									See Number Code Table.
14	x (fourth digit)									See Number Code Table.
15	y (fourth digit)									See Number Code Table.

- Data output starts with the most significant bit (bit 7) and ends with the least significant bit (bit 0).

Number Code Table

Binary code								Hexadecimal code	Displayed	Binary code								Hexadecimal code	Displayed
1	0	0	0	0	0	1	0	82	0	1	0	1	0	0	0	0	0	A0	6
0	0	0	0	0	0	1	0	02	0.	0	0	1	0	0	0	0	0	20	6.
1	0	0	1	1	1	1	1	9F	1	1	0	0	0	1	1	1	0	8E	7
0	0	0	1	1	1	1	1	1F	1.	0	0	0	0	1	1	1	0	0E	7.
1	1	0	0	0	0	0	1	C1	2	1	0	0	0	0	0	0	0	80	8
0	1	0	0	0	0	0	1	41	2.	0	0	0	0	0	0	0	0	00	8.
1	0	0	0	0	1	0	1	85	3	1	0	0	0	0	1	0	0	84	9
0	0	0	0	0	1	0	1	05	3.	0	0	0	0	0	1	0	0	04	9.
1	0	0	1	1	1	0	0	9C	4	1	1	1	0	0	0	0	0	E0	E
0	0	0	1	1	1	0	0	1C	4.	0	1	1	0	0	0	0	0	60	E.
1	0	1	0	0	1	0	0	A4	5	1	0	1	1	0	0	0	0	80	b
0	0	1	0	0	1	0	0	24	5.	1	1	1	1	1	1	1	1	FF	Blank

If an error display (“E,” “E0,” “E1,” “E9”) occurs, data is output according to the above Number Code Table. If error display “b0” occurs, no data is output.

MEASURING SYSTEM

Light from the subject passes through the optical system, including protective lens filter and objective lens, to the chopper and into the optical fiber cable. The light is divided into three parts by the optical fiber cable and each part is incident upon a sensor. Each sensor is adjusted with a spectral-response correction filter to one of the standard CIE color-matching functions: $\bar{x}_{2\lambda}$, \bar{y}_λ , or \bar{z}_λ (CS-100A uses CIE 1931 2° Standard Observer spectral response). Incident light is converted by the sensors to current signals, which are converted to voltage signals, and then changed to digital signals by the A/D converters. These signals are then used by the microcomputer to calculate the luminance Y and chromaticity coordinates x and y, which are then shown in the displays.

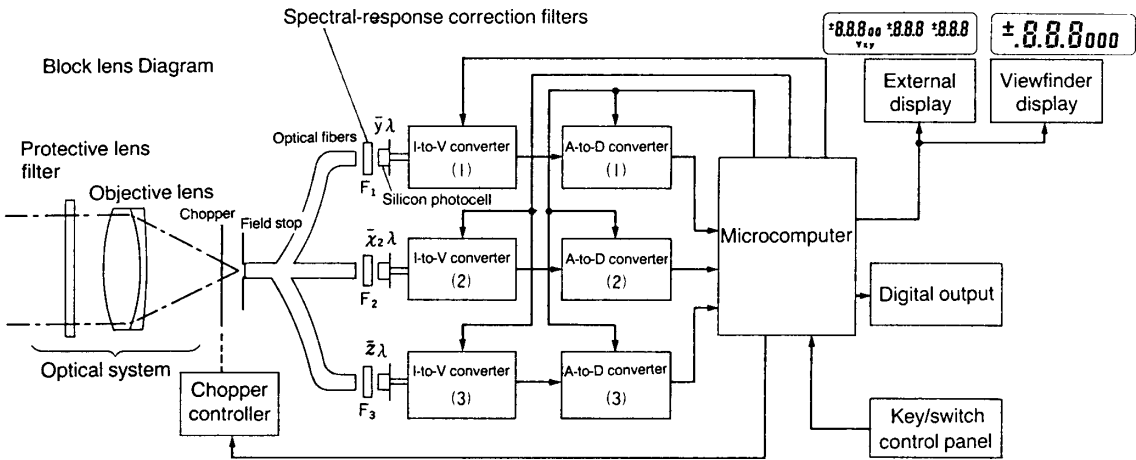

Spectral response

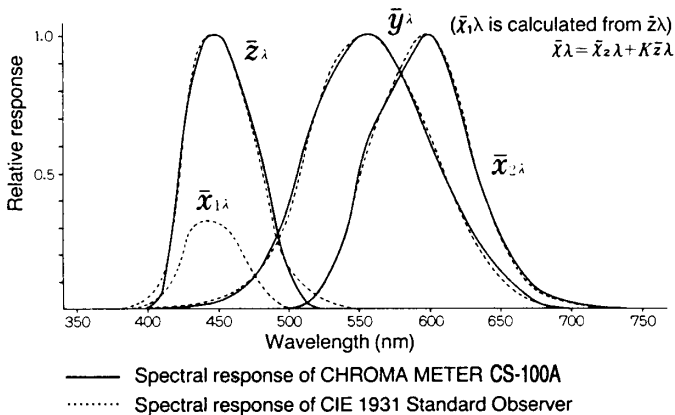

Optical System

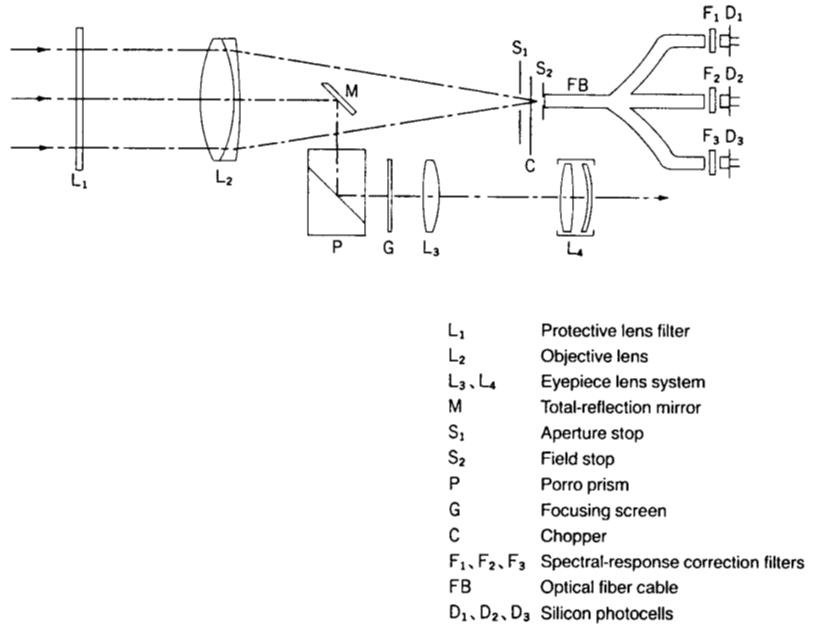

As shown in the above figure, Konica Minolta optical technology is used to realize a handheld metering system. Use of an in-viewfinder display also enables simultaneous confirmation of the measurement area and measured luminance value, resulting in a more compact, lightweight chroma meter. The endface of the optical fiber cable is located where the objective lens focuses, as are the display and focusing screen with circular measurement-area indication.

Viewfinder display

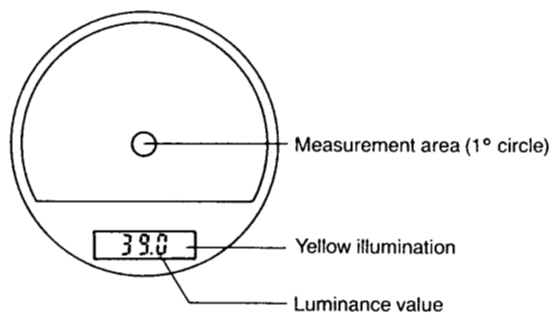

The measurement area and measured luminance value can be simultaneously confirmed in the viewfinder as shown in the figure above. The display is a digital liquid-crystal display (LCD) illuminated with a yellow LED.

FACTORY STANDARD CALIBRATION PROCEDURE

The CALIBRATION selector switch of the CS-100A may be set to the PRESET position for taking measurements based on factory standard calibration. This calibration is adjusted at the factory before shipping as follows.

Luminance

The luminance response of the CS-100A is adjusted by using the equipment shown below.

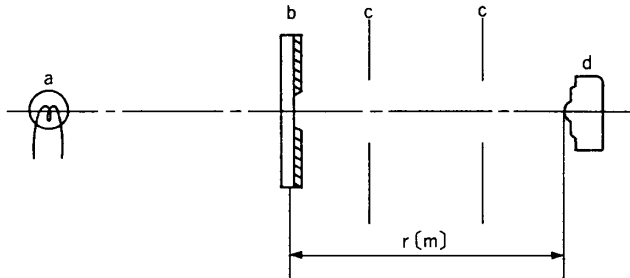

- a: Luminous intensity standard lamp calibrated by the Electro Technical Laboratory of the Japanese Ministry of International Trade and Industry
- b: White transmitting diffuser plate attached to an aperture plate of known area
- c: Series of baffles to ensure that the influence of flare is reduced to a minimum
- d: Meter position

PROCEDURE

1. A previously calibrated illuminance meter is placed at the meter position and a measurement of the illuminance at this point is taken.
2. This illuminance is used to calculate the luminance at the same position according to the formula:

$$L = (Er^2)/A$$

where: L = Luminance at diffuser (in cd/md²)

E = Measured illuminance at meter position (in lux)

r = Distance from diffuser plate to meter position (m)

A = Area of opening in aperture plate (m²)

3. The CS-100A to be calibrated is placed in the meter position and adjusted until the luminance (Y) value in the display is equal to the value of L calculated from the above equation.

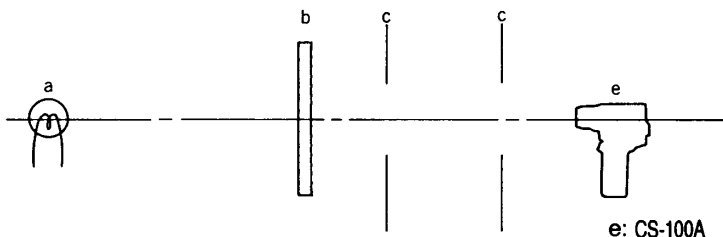

e: CS-100A

Chromaticity Coordinates

The chromaticity coordinates are adjusted using a spectral radiation standard lamp at 3111K which has been calibrated by the Electro Technical Laboratory of the Japanese Ministry of International Trade and Industry.

Yxy COLOR SYSTEM

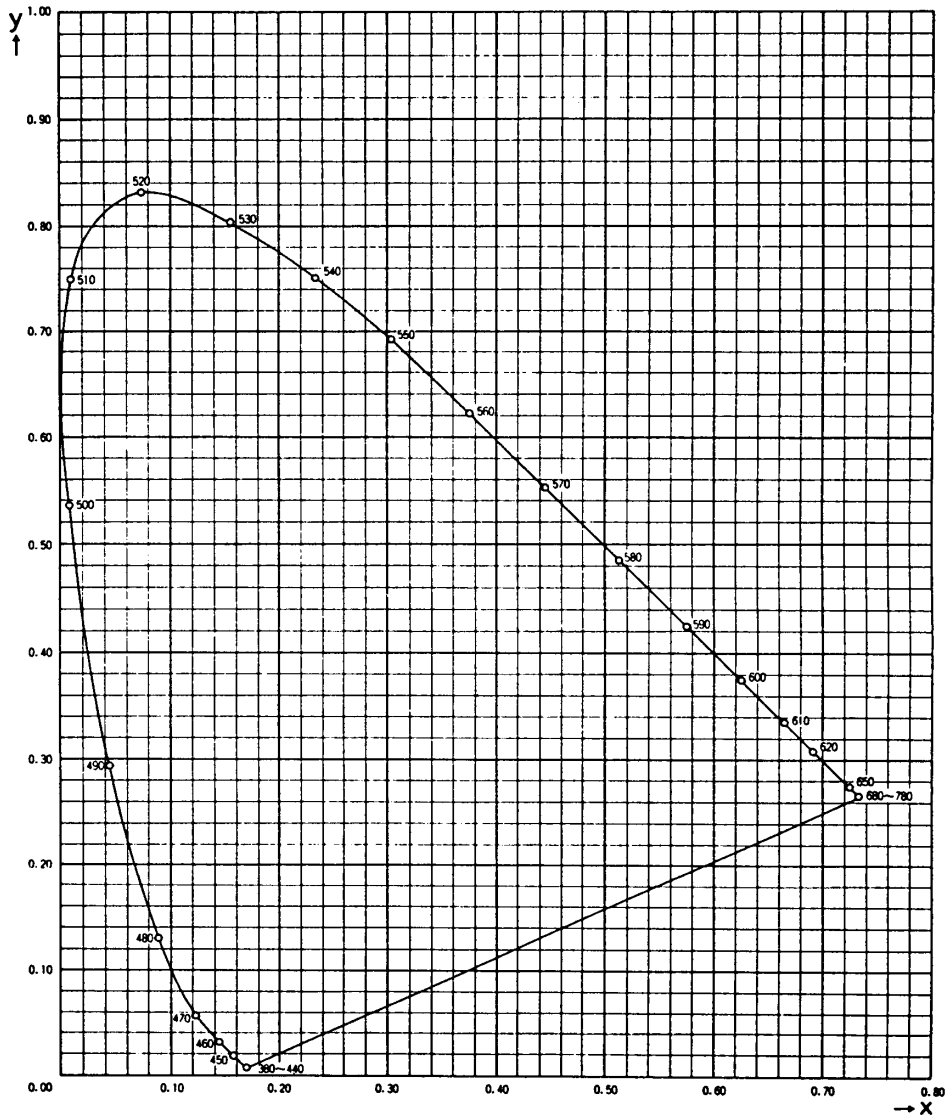

For two colors to match, three quantities defining these colors must be identical. These three quantities are called tristimulus values X, Y, and Z as determined by the CIE (Commission Internationale de l'Eclairage) in 1931.

Color as perceived has three dimensions: hue, chroma and brightness. Chromaticity includes hue and chroma (saturation), specified by the x and y coordinates in the CIE Chromaticity Diagram (below). Since this two-dimensional diagram cannot describe a specific color completely, a brightness factor must also be include to identify a sample precisely.

Y is the luminance expressed in terms of cd/m² or fL; x and y are chromaticity coordinates of the CIE x, y Chromaticity Diagram, defined by the equations below:

$$x = \frac{X}{X+Y+Z} \quad y = \frac{Y}{X+Y+Z}$$

X, Y, Z tristimulus values may be calculated from Y, x, y values by using the equations below:

$$X = \frac{x}{y}Y \quad Y = Y \quad Z = \frac{1-x-y}{y}Y$$

CARE AND STORAGE

- Do not touch the front lens surface. If it becomes dirty, remove any loose dust with a blower or compressed air, and wipe lightly with lens tissue if necessary. For safety, cover lens with the lens cap when not using meter.
- When dirty, the meter may be wiped with a silicone-treated cloth or other clean, dry cloth. Do not allow alcohol or chemicals to touch the meter's surface.
- If the meter is used at temperatures higher than 40°C (104°F) or less than 0° C (32° F), operation may be unsatisfactory.
- Do not leave the meter in places subject to high humidity or to temperatures higher than 55°C (131°F) (such as inside a closed motor vehicle), or lower than -20°C (-4°F).
- Do not leave the meter in direct sunlight or near sources of heat, such as stoves, strong lights etc.
- Never look through the viewfinder and aim the CS-100 at the sun. Doing so may damage your eyes and the meter's photocell.
- Do not aim the lens at the sun during transportation or storage. For safety, cover lens with the lens cap when not using the meter.
- Do not subject the meter to shock or vibration.
- Do not press on the liquid-crystal display window.
- Never attempt to disassemble the meter. Any necessary repairs should be done only by an authorized Konica Minolta service facility.
- When the meter is to be stored for an extended period of time, remove the battery, place the meter in its original packaging and put it in an air-tight container with a dehumidifying agent, such as silica gel.

TECHNICAL DETAILS

Type:	TTL spot colorimeter for measuring light-source and reflected-light color
Receptors:	3 silicon photocells filtered to detect primary stimulus values for red, green, and blue light
Spectral response:	Closely matches CIE Standard Observer curves ($\bar{x}_{2\lambda}$, \bar{y}_{λ} , and \bar{z}_{λ})
Measuring modes and chromatic systems:	Absolute color: Yxy (CIE 1931) Color difference: $\pm \Delta (Yxy)$
Calibration:	PRESET: Konica Minolta standard calibration VARI: User-selected calibration reference
Color-difference mode:	One memory channel for storing target color values (measured or input); difference from stored values determined by meter and displayed
Optical system:	85mm f/2.8 lens; TTL (through-the-lens) viewing system
Acceptance angle:	1°
Field of view:	9° (with circular 1° indication)
Focusing distance:	1014mm to infinity (minimum of 203mm using optional close-up lens)
Minimum target area:	ϕ 14.4mm at 1014mm (1.3mm using optional close-up lens)
Luminance units:	cd/m ² or fL selectable
Luminance measuring range:	FAST: 0.01 to 299000 cd/m ² (0.01 to 87500 fL) SLOW: 0.01 to 49900 cd/m ² (0.01 to 14500 fL)
Accuracy:	Luminance (Y): $\pm 2\%$ of reading, ± 1 digit in last-changing display position Chromaticity: ± 0.004 Based on Konica Minolta's standard test methods
Short-term repeatability:	Luminance (Y): $\pm 0.2\%$ of reading, ± 1 digit in last-changing display position Chromaticity (x, y): FAST: Y above 100 cd/m ² : ± 0.001 Y from 48.1 to 99.9 cd/m ² : ± 0.002 Y below 48.0 cd/m ² : below measurement range SLOW: Y above 25.0 cd/m ² : ± 0.001 Y from 12.0 to 24.9 cd/m ² : ± 0.002 Y below 11.9 cd/m ² : below measurement range Based on Konica Minolta's standard test methods
Displays:	External LCD panel: shows digital Y, x, and y values plus operation and error indications Viewfinder LCD panel: shows digital Y value
Interface:	RS-232C standard Baud rate : 4800bps
Power source:	One 9V battery (Eveready 216 or equivalent); external power supply may be used via data-output terminal
Operating temperature:	0 to 40°C (32 to 104°F) relative humidity less than 85% at 35°C with no condensation
Storage temperature:	-20 to 55°C with no condensation (-4 to 131°F)
Dimensions:	208 × 79 × 154mm (8 ³ / ₁₆ × 3 ¹ / ₈ × 6 ¹ / ₁₆ in.)
Weight:	890g (31 ³ / ₁₆ oz.) without battery
Standard accessories:	Lens cap, protective filter, eyepiece cap, neutral density eyepiece filter, digital output terminal cover, battery, case
Optional accessories:	Close-up lenses, DP-101, white calibration plates

Specifications subject to change without notice



KONICA MINOLTA