

MULTI GLOSS 268A
UNI GLOSS 60A
UNI GLOSS 60CT
UNI GLOSS 60S

Instruction Manual

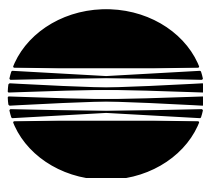

KONICA MINOLTA

MULTI GLOSS 268A
UNI GLOSS 60A
UNI GLOSS 60CT
UNI GLOSS 60S

Instruction Manual

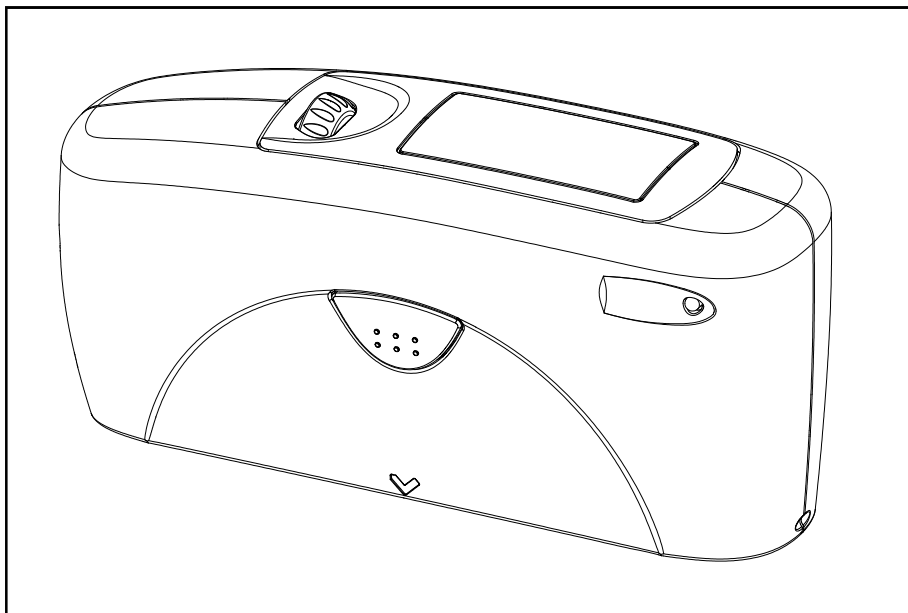

Patent pending

260 023 933 E 1609

Table of content

1. Safety Symbols	6
2. Safety Precautions	7
3. Notes on Use	8
4. System description	13
5. Power supply	14
5.1 Power supply battery-operated	14
5.2 Changing the battery	15
5.3 External power supply	15
6. Controls	16
7. Getting started	18
7.1 Turning on the unit and measuring	18
7.2 Navigation	19
7.3 Change names/numbers	20
7.4 Overview of main menu	21
8. Calibrate	22
8.1 Autodiagnosis	22
8.2 Calibrate	23
8.2.1 Gloss	23
8.2.2 Change cal.values	24
8.2.3 Status	25
8.2.4 Scale Gloss	25
8.3 Calibrating standards	26
8.4 Checking standard	26
9. Measurement techniques	27
9.1 Paints and varnishes, plastics and similar materials	27
9.2 Anodized aluminum and other metal surfaces	28
10. Measurement Modes	29
10.1 Sample mode	29

10.2 Statistics	30
10.2.1 Number of measurements	31
10.2.2 Display	31
10.2.3 Exit block	33
10.2.4 Delete block	33
10.2.5 Delete measurement	33
10.3 Continuous	34
10.4 Basic mode	35
11 Geometry	36
11.1 Geometry selection	36
12. Memory	37
12.1 Memory	37
12.2 Select memory	37
12.3 Create memory	38
12.4 Delete memory	38
12.5 Display memory	38
13. Difference measurement and Pass/Fail	40
13.1 Difference	40
13.2 Measure standard	40
13.3 Select standard	41
13.4 Create standard	42
Define standard	42
13.5 Change standard	43
13.6 Delete standard	43
14. Setup	44
14.2 Date/Time	44
14.3 Beeper	44
14.4 Display time	44
14.5 Language	45
14.6 Info	45
15. Interface	46
16. Standards	47
17. Specifications	48

18. Accessories	49
19. Errors and warning messages	50
20. Cleaning and maintenance	52
21. Copyright	53

1. Safety Symbols

The following symbols are used in this manual and the instrument to prevent accidents which may occur as a result of incorrect use of the instrument.



- Denotes a sentence regarding a safety warning or note. Read the sentence carefully to ensure safe and correct use.



- Denotes a prohibited operation. The operation must never be performed



- Denotes a prohibited operation. Never disassemble the instrument.













- This symbol indicates direct current (DC).

Notes on this manual

- Copying or reproduction of all or any part of the contents of this manual without permission of the manufacturer is strictly prohibited.
- The contents of this manual are subject to change without prior notice.
- Every effort has been made in the preparation of this manual to ensure the accuracy of its contents. However, should you have any questions or find any errors, please contact the store where you purchased the instrument.
- The manufacturer will not accept any responsibility for consequences arising from the use of the instrument.

2. Safety Precautions

To ensure correct use of this instrument, read the following points carefully and adhere to them. After you have read this manual, keep it in a safe place where it can be referred to anytime a question arises. If you pass this instrument to somebody else, make sure to include these instructions.

 WARNING (Failure to adhere to the following points may result in death or serious injury.)	
 <p>Do not use the instrument in places where flammable or combustible gases (gasoline etc.) are present. Doing so may cause fire.</p>	 <p>Do not disassemble or modify the instrument or the Power supply. Doing so may cause a fire or electric shock.</p>
 <p>Take special care not to allow liquid or metal objects to enter the instrument. Doing so may cause a fire or electric shock. Should liquid or metal objects enter the instrument, disconnect the Power supply from the AC outlet immediately, and contact the store where you purchased the instrument.</p>	 <p>The instrument should not be operate if it is damaged, or if smoke or odd smells occur. Doing so may result in a fire. In such situations, remove the battery and/or immediately disconnect the USB interface cable, and contact the company where you purchased the instrument.</p>
 <p>Do not dispose of batteries in fire, short the terminals, apply heat to them, or disassemble them. Also, do not recharge them. Doing so may cause explosion or heat generation, resulting in fire or injury.</p>	 <p>Do not touch the battery with wet hands. Doing so may cause electric shock.</p>
 CAUTION (Failure to adhere to the following points may result in injury or in damage to the instrument or other property)	
 <p>Do not use batteries other than those specified. When installing batteries in the instrument, make sure that they are correctly oriented according to the (+) and (-) marks. Failure to adhere to these instructions may cause batteries to explode or leakage of electrolytes, resulting in fire, injury or air pollution.</p>	 <p>Only devices that meet the requirements for low-voltage safety can be connected to the USB interface.</p>

3. Notes on Use

- The measurement unit consists of sensitive precision optical and electronic parts.
Do not drop it. Protect it from being bumped or jostled.
- Do not hold the unit by the measurement aperture. You should not allow any foreign objects to get into this opening.
- Do not expose the unit to direct sunlight for extended periods of time. Do not store it in a hot or dusty environment. The case that comes with the unit offers the best protection when the unit is being stored.
- Avoid prolonged high relative humidity and do not allow condensation to form.
- Protect the measuring unit from moisture, chemicals and corrosive vapors.
- The holder and the unit housing are resistant to a number of solvents. However, we cannot guarantee resistance to all chemicals. You should therefore use a soft, moist cloth for cleaning. For clean excessive dirt and dust, use ethanol or cleaning alcohol.
Do not use any acetone!
- If you will not be using the measuring unit for an extended period of time, remove the battery to prevent it from leaking in the unit and thus potentially causing damage.

- Do not replace the internal backup battery yourself. Contact the nearest authorized service facility to replace the backup battery.
- If the instrument is subjected to strong static electricity, the display may become blank. If this occurs, wait for the power to be automatically switched off, and then switch the power on again.
- Do not perform any repairs on the unit yourself. The unit must be opened by trained professions only. Please contact our customer service department in such cases.
- Do not use accessories other than those specified by KONICA MINOLTA INC.
- Pollution degree 2: Use it in areas where there is no metal dust and no possibility of condensation.
- Do not use at altitudes of higher than 2000m.

Additional information on use:

- Make sure that the instrument, accessories and used battery are either disposed of or recycled correctly in accordance with local laws and regulations.

For EU member states only:

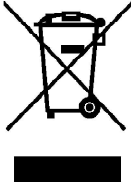

This symbol means: Do not dispose of this product together with your household waste.

Please refer to the information of your local community or contact our dealers regarding the proper handling of end-of-life electric and electronic equipment.

Recycling of this product will help to conserve natural resources and prevent potential negative consequences for the environment and human health caused by inappropriate waste handling.

For EU member states only:



This symbol on the batteries or on the packaging indicates that the batteries provided with this product shall not be disposed of as unsorted municipal waste. If chemical symbol Cd, Hg or Pb is placed beneath the symbol, the symbol means that the battery or accumulator has a heavy metal content that exceeds a certain concentration level. By contributing to the collection and recycling of waste batteries, you will help to reduce potential effects on the environment and human health that could otherwise arise from inappropriate waste handling.

In case of products that require a permanent connection with incorporated batteries for safety, performance, medical or data integrity reasons, the batteries are not readily removable and are not intended to be replaced and disposed of separately from the products by end users. These types of batteries will be separated by recyclers during the treatment phase of the products as required under the WEEE Directive 2002/96/EC.

For all other batteries, please refer to the section in the instruction manual on how to remove the batteries from the products safely and take the used batteries to the applicable collection point, in

accordance with your national legislation and the Directive 2006/66/EC.

For more detailed information about recycling of products or batteries, please contact your local municipality, collection/recycling services or shops where you purchased the product.



For China only

4. System description

Measurement units of the portable glossmeter family can be used to determine the gloss level of paint coatings, plastics, ceramics and metal surfaces.

Light is directed at the surface of the sample at a defined angle and the reflected light is measured photoelectrically (reflectometer).

Depending on the typical gloss level of the test object, reflectometers that direct light onto the surface at different angles (geometry) can be used.

Measurement units are equipped with standard geometries of 20°, 60° or 85°. All three of these geometries are integrated into the three angle units. Functions described in this manual in terms of geometry selection are only available with the three angle device.

In addition to measuring individual gloss values, it is also possible to record, save and statistically evaluate series of measurements consisting of up to 999 values.

The operate button and scroll wheel are used to control the system. System operation is supported by display messages (autodiagnosis and error messages).

The measurement unit conforms to the standards ISO 2813, ASTM D 523, ASTM D 2457, DIN 67530 and ISO 7668, JIS Z 8741 (excluding 60°S)

Comes complete with:

Measurement device

Protective holder with integrated calibration tile

Traceable certificate

USB-cable

Quick user guide and Safety instructions

Battery

Carrying case.

Additionally, Software and Operating manual can be downloaded from the support section of the instrument suppliers website.

5. Power supply

Before operating the instrument for the first time, please read the operating instructions and pay attention to the Safety Precautions in Chapter 2.

Unpack the device and check to make certain all pieces have been included with delivery (for scope of delivery, see section System description).

5.1 Power supply battery-operated

The battery must be placed in the measuring unit for operation service. The device runs on one AA 1.5-V alkaline or 1.2-V NiMH rechargeable battery.

Use only alkaline batteries or NiMH rechargeables (AA /LR6)!

Depending on the exact brand, the capacity of each battery is sufficient for about 4.000 measurements. When the battery voltage falls below the required minimum voltage in the course of operation, the following message appears on the display

Battery low!

To ensure that the unit is always ready for operation, it is recommended to have a spare battery handy, especially when performing measurements in the field.

5.2 Changing the battery

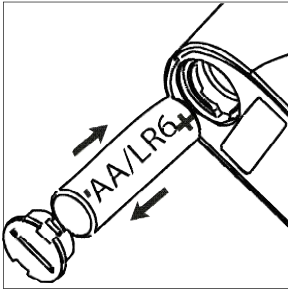

Changing the battery

To insert or change the battery open the battery compartment. The easiest way to do this is by turning the cover with a coin one-eighth of a rotation to the left. Turn the device back around and allow the old battery and the battery compartment cover to slide into your hand.

Insert the new battery with the positive (top) end first into the battery compartment and set the battery compartment cover in place again. Lock the cover by turning it one-eighth of a rotation to the right.

5.3 External power supply

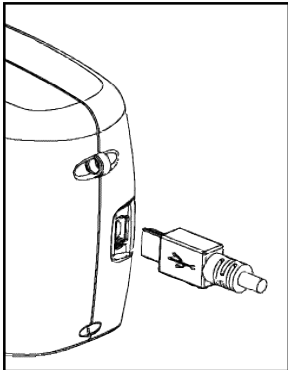

The instrument can be operated and supplied at a computer via USB-port. For the connection to the PC use the USB- cable included in the delivery.

Please refer to the chapter Interface for installation of the required software and drivers.

For power supply specification note the technical data.

6. Controls

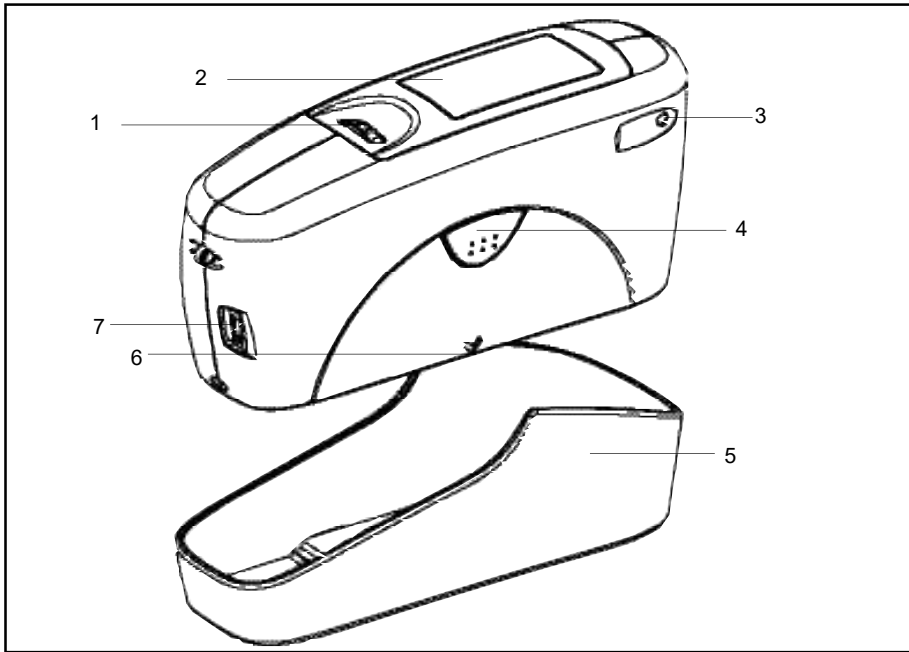

Measurement unit and protective holder

- 1 Mode scroll wheel: used to turn the unit on and for menu selection
- 2 Display for user guidance and displaying measurement values
- 3 Signal lamp:
green: measurement active
red: error
- 4 Operate button: used to activate measurements
- 5 Protective holder with integrated calibration standard
- 6 Mark for the measurement aperture
- 7 USB interface for connecting to a PC

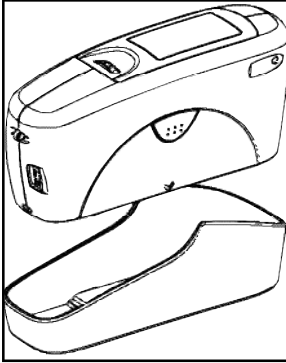

The basic system consists of the measuring device and the protective holder.

The protective holder is used for calibration and to store the measurement unit. Calibration is performed inside the holder automatically at the touch of a button. The gloss standard required for this purpose is kept in the holder and is positioned in such a manner that calibration is always performed at the same point.

When the device is turned on inside the holder, it performs a self-test (autodiagnosis).

If you will not be using the measuring unit, please store it in the protective holder. In this way the measurement optics are protected from dirt and dust and the calibration standard is always readily available.

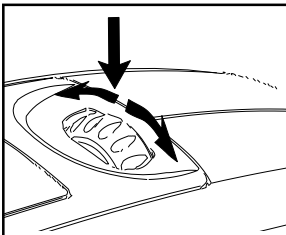

The operate button and scroll wheel are used to control the system. Pressing the wheel turns the unit on and causes a menu to be displayed. All settings within the menus are made by turning and pressing the wheel.

Pressing the operate button starts measurements or performs functions that are displayed. In addition, you can return from the various menus to mode with the operate button. System operation is supported by an autodiagnosis test, comments and error messages. Measurement values and comments appear in the display.

7. Getting started

7.1 Turning on the unit and measuring

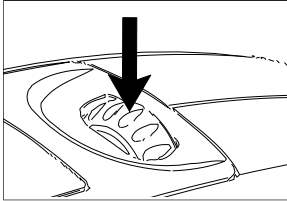

To turn on the unit, press the mode scroll wheel.

Information on the date and last certification appears in the display. If the device was turned on in its holder, the autodiagnosis test is performed (see the section on Calibration).

Autodiagnosis	
20°	OK
60°	OK
85°	OK

Then the unit switches into the last measurement mode to be selected.

Pressing operate initiates measurements.

A	B	C	D
M20°60°85°		SAMPLE 001	
STANDARD 1		n=02/08	
	value	\bar{x}	p / f
20°	56.5	56.3	FAIL
60°	82.9	82.4	Pass
85°	86.7	87.1	Pass

The display of measurement results on the screen may be broken down into the following elements:

A: When Difference measurement is turned on, the name of the standard that is selected is displayed here.

B: If Memory is selected, the memory area that is selected appears at the top left and for

C: the sample name (block name).

D: If Statistics or Continuous is turned on, the number of measurements performed or selected is displayed here.

The measurement values appear in the lower part of the display area. The size of the numbers depends on whether Statistics or Difference measurement has been activated and on the number of geometries displayed. Depending on the measurement mode, a header line also appears for the measurement values.

7.2 Navigation

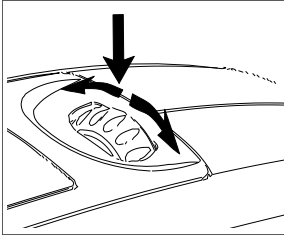

All control functions are controlled by the mode scroll wheel. Pressing the wheel causes a menu to appear in the display. Turning the wheel allows you to move the black mark to the desired function and to select or activate it by pressing the wheel.

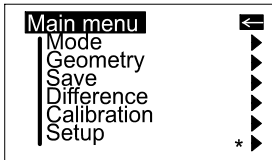

What functions are displayed in the menu depends on the settings in the main menu. The main menu is the “central” level and can always be reached quickly.

Certain rules apply within the menus to make it easier to navigate:

- ▶ A black triangle to the right of a function indicates that selecting this function will take you to a sub-menu.
- ✓ A check mark on the right indicates that the function in question has been activated.
- ← You can use the arrow at the top right to switch the display back by one level.

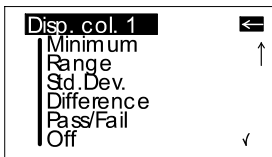

Arrows pointing up or down indicate that there are other menu options above or below the part of the menu that is visible. To reach these menu options, simply turn the scroll wheel in the direction in which the arrow is pointing.

You can quickly switch back from the menus to the measurement display by using the operate button. In some cases this button also has another function, but that will be indicated in the display (for example Confirm -> operate).

7.3 Change names/numbers

Display time
Seconds: 25
 ↑
Cancel --> [operate]

For some functions, you can enter or change the date or name. The arrow pointing upward marks the position that can be changed. To change the character, turn the scroll wheel. When you press the wheel, the arrow jumps to the next character.

After you have adjusted the last character or number, confirm your input by pressing the wheel.

Input name
SAMPLE 002
 ↑
Confirm --> [operate]

When you enter the name, the arrow jumps to the first character. This allows you to correct any inadvertent incorrect entries. You can confirm the name in these menus at any time with the operate key.

7.4 Overview of main menu

Mode

Sample mode	Measurement without statistical evaluation.
Statistics	Multiple measurement with statistics.
Continuous	Continuous measuring with adjustable interval.
Basic mode	Measuring without statistics, saving and difference.
Advanced mode	Reactivates all menus and functions when Basic mode was activated.

Geometry

Select geometry.

Memory

Memory	Memory functions: Turn saving on/off.
Select memory	Select memory area from list.
Create memory	Enter up to 50 memory areas.
Delete memory	Delete memory content or memory name.
Display memory	Recall of memory content (use scroll wheel).

Difference

Difference	Settings for difference mode: Turn difference measurement on/off.
Measure standard	Measure a standard.
Select standard	Select standard (if saved).
Create standard	Enter up to 50 standards and limits for Pass/Fail.
Delete standard	Delete individual standards.
Changestandard	Enter/change limit values for Pass/Fail.

Calibration

Calibrate, change cal. values, GU - % scale.

Setup

Date/Time, Beeper, Display time, Language, Info

The following can be used together simultaneously:

- Memory with: Sample mode, Statistics, Continuous
- Difference with: Sample mode, Statistics

8. Calibrate

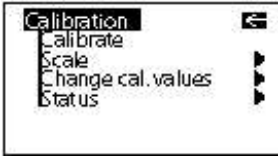

The holder with the integrated glass standard is used for calibration. Always keep the measurement unit in the holder. This protects the measurement optics and ensures that the standard is always at hand.

If you have several devices of this type, you must put the unit in the holder which belongs to the unit (see the serial number).

Make certain that the standard is clean and there are no cracks on it.

When you place the device in the holder, make certain that it ships firmly into place.

8.1 Autodiagnosis

Whenever you turn on the device in the holder, it first performs a self-test. During this test, any changes in the measurement signal are tested against saved calibration data. This allows for a long-term calibration so that a new calibration is required only about once a week. Beyond that, calibration is only necessary if there are significant weather changes (see under 8.2). It is recommended that you perform the self-test in the holder regularly (every day).

The autodiagnosis generally takes about 2 seconds. "Please clean standard" or "Please test standard" may be displayed. For more information on cleaning, see Chapter 20.

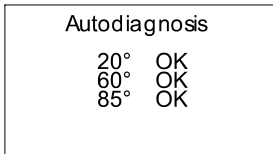

A message will appear in the display informing you that the autodiagnosis has been completed successfully.

In some cases, the system may suggest that you repeat the calibration. The reason for this may be changed ambient conditions. It is also possible, however, that the standard still has small amounts of residue left over from cleaning. This problem can generally be alleviated by cleaning with a dry optical cleaning cloth.

8.2 Calibrate

You should recalibrate the device if ambient conditions have changed. This applies especially when changing location if major changes in temperature and relative humidity may be expected as a result (for example inside/outside).

When moving from cold areas to warm areas, there is a danger of condensation. For this reason, after there has been a change in ambient conditions, you should wait for an appropriate amount of time to allow the optical components to adjust before calibrating and using the unit.

Main menu
▶ Calibration
▶ Calibrate
▶ **Gloss**

Use the path shown on the left side to reach the Calibrate menu option.

8.2.1 Gloss

Calibration	
20°	93.3
60°	95.7
85°	99.4

To begin calibration, press the scroll wheel.

The calibration process is performed automatically for all three geometries. The saved calibration values of the standard appear in the display.

The unit then returns to the selection menu Calibration.

8.2.2 Change cal.values

The gloss values of the calibration standard in the holder included with delivery are saved in the measuring device. During automatic calibration, this data is assigned to the standard in the holder.

In some cases it will be necessary to enter data for a new calibration standard, for example if the previous standard has been damaged or scratched.

To ensure exact calibration, only original standards from the manufacturer should be used.

You can use the path shown on the right side to reach the Change cal.values menu option.

Main menu
▶ Calibration
▶ **Change cal.values**

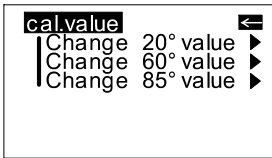

At three angle units, a selection menu will appear for geometries. Select the desired geometry and press the scroll wheel.

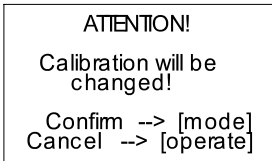

A warning message appears. You can cancel this process by pressing the operate button. If you press the scroll wheel, you will continue with the process of changing calibration values.

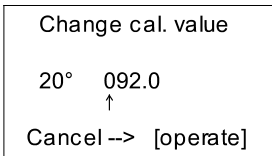

In the next display you can enter new calibration values.

Change cal. value
20° 092.0
Confirm --> [mode]
Cancel --> [operate]

After you have entered the new value, a warning message appears again in the display. You can again abort the process with operate.

If you confirm the new value by pressing the scroll wheel, the value will be accepted.

After you have changed all necessary values, you should recalibrate the measurement device as usual.

8.2.3 Status

Status		
20°	ERROR02	Last calib 01.01.04
60°	95.7	01.01.04
85°	99.4	01.01.04

This menu item provides you with information on the calibration status of the unit.

In particular, you can check here whether the saved calibration values match those of the holder. The display also indicates if an error message was generated as a result of the last autodiagnosis or calibration. If this has happened, further information is available under Section Errors and warning messages.

8.2.4 Scale Gloss

Scale		
Gloss Units	GU	✓
Reflectance	%	

You can use the Scale menu option to switch back and forth between Gloss Units and Reflectance (see the Section on Practical measuring suggestions). Move the mark to the desired entry and press mode. A check mark identifies the Scale that is selected. After you switch the Scale, the unit must not be recalibrated.

8.3 Calibrating standards

To ensure exact calibration, only original standards from the manufacturer should be used.

These are calibrated against tested primary standards. Their surface must not be touched and must be protected against scratches. Due to environmental influences, however, the values of standards can change over the course of time even if they are handled gently. For this reason, you should have the calibration standards tested by the manufacturer at regular intervals (we recommend annually).

8.4 Checking standard

We recommend the regular use of a separate test standard for control of test equipment. The frequency of this verification depends on the conditions of usage (for example monthly). The gloss standards are integrated into an aluminum guide in which the measurement device is positioned exactly. Perform the measurement as you would normally, for example in Basic mode. The displayed measurement value must not deviate from the value printed on the standard by more than one unit. Otherwise you should check whether there is dirt and dust on the high gloss standard in the holder or test standard. If cleaning and recalibration do not offer any improvement, please get in touch with our Customer Service.

9. Measurement techniques

In accordance with the standard, the reflectometer value is related to a black glass standard at a defined index of refraction (generally 1.567) which is thus equal to 100 units.

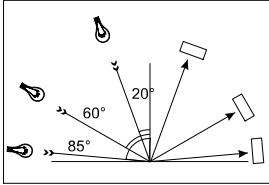

Reflectometers are differentiated by the angle of incidence of the illuminating mechanism. Geometries are set in the standards at 20°, 60° and 85°.

9.1 Paints and varnishes, plastics and similar materials

The various geometries are distinguished according to their fields of application as follows:

Semi-gloss surfaces are measured at an angle of incidence of 60° and should fall within a range from 10 to 70 gloss units.

Highly reflective surfaces with measurement values exceeding 70 units in the 60° geometry should be measured at 20°.

On the other hand, matte surfaces with less than 10 gloss units (at 60°) should be measured at the 85° geometry.

9.2 Anodized aluminum and other metal surfaces

The measuring unit is equipped with an extended measuring range for measuring samples with a very high reflectance.

The reflectance of non-metallic surfaces increases with the angle of incidence. The reflective properties of metals do not always behave in this manner. Because of double reflection, the light is partially reflected on the coating and partially on the metal underneath. For a complete understanding of the reflective properties of such surfaces, it is recommended to measure them at all geometries.

In addition to the reference to a black glass standard (gloss units), it is also common in the area of metals to relate the reflectometer value to the amount of irradiated light and to express it as a % (reflectance). You can select this in the Scale menu.

Main menu
▶ Calibration
▶ **Scale**

Notes

Proper measurements are only possible on level surfaces.

Measurements on dirty, scratched or otherwise distorted areas of the test specimen are not meaningful except as a way of determining the degree of such imperfections by means of a gloss measurement.

Since it cannot be assumed that the gloss capacity is not constant over the entire surface of the test specimen, the reflectometer value can be measured at several different places and the standard deviation can be determined.

If the sample exhibits structures or directionally dependent gloss properties, the structural features and the direction of the incident light should be specified for the measurement in the test report.

Samples that must be measured several times over the course of an examination (for example weathering samples) should be marked accordingly to ensure that the measurement is made at the same point during repeated tests.

10. Measurement Modes

You can select different types of measurement in the Mode menu. The mode that is activated is identified by a check mark.

10.1 Sample mode

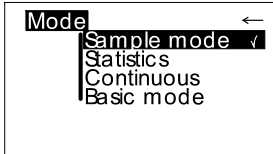

Single measurements can be performed without statistical evaluation in Sample mode.

The results can be saved and compared with a standard (refer to Memory or Difference).

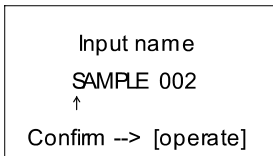

When Memory is turned on, a name is suggested after every measurement. You can confirm this name directly or change it.

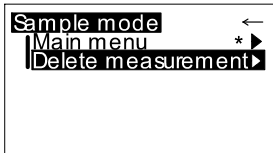

If you would like to delete the last measurement, press the scroll wheel and select the appropriate menu item.

10.2 Statistics

Main menu
▶ Mode
▶▶ Statistics

You can make multiple measurements with each sample in Statistics mode. These measurements will be evaluated statistically and displayed.

	n=02/03			
	value	\bar{x}	stdev	
20°	54.7	54.1	0.3	
60°	81.6	82.1	0.2	
85°	86.7	86.9	0.4	

The results can be saved and compared with a standard. These functions must be previously activated (refer to Memory or Difference).

Input name
SAMPLE 002
↑
Confirm --> [operate]

When Memory is turned on, a name is suggested after all measurements of a sample (block). You can confirm this name directly or change it.

Statistics
Main menu *▶
Number of meas. *▶
Display ▶
Exit block ▶
Delete block ▶
Delete meas. ▶

When the Statistics function is turned on, additional functions are available depending on the context after you press the scroll wheel.

10.2.1 Number of measurements

Number of readings per mean value

n= 03

↑

Cancel --> [operate]

You can adjust the number of measurements per sample or per block with this option, from 2 - 99.

	value	\bar{x}	stdev
20°	54.7	54.1	0.3
60°	81.6	82.1	0.2
85°	86.7	86.9	0.4

You can find this value in the measurement display by looking for “n=” after the forward slash. The number of measurements (which increases by one each time a measurement is performed) appears before the slash.

10.2.2 Display

In the Statistics measurement display, you can assign the following data freely to three columns:

Sat. display

Column 1: value

Column 2: \bar{x}

Column 3: stdev

Value:

Last value to be measured

Mean value:

Arithmetic mean of the sample (block).

Maximum:

Highest measurement value of the sample

Minimum:

Lowest measurement value of the sample

Range:

The difference between the maximum and minimum value.

Disp. col. 1

Value

Mean value

Maximum

Minimum

Range

Dev.Std..

Std. Dev.:

The standard deviation of the sample

$$S = \sqrt{\frac{1}{n-1} \sum_{i=1}^n (x_i - \bar{x})^2}$$

Difference*:

The difference between the sample and a target value.

Pass/Fail*:

Pass is displayed if the sample value falls within the specified limits, or Fail if it falls outside.

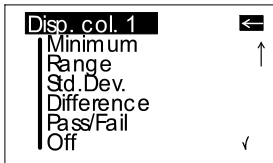

Off:

Turns off the display of the selected column.

* To be able to use these functions, a standard must be measured, created or selected. In particular, a limit value must be defined.

10.2.3 Exit block

Statistics

- ▶ Exit block
- ▶ Delete block
- ▶ Delete meas.

This function terminates the block before it reaches the required number of measurements n . It is useful if you have selected a high number of measurements for n , for example in the case of large samples.

Input name
SAMPLE 002
↑
Confirm --> [operate]

If Save is turned on, a display appears to enter a block name for the sample.

10.2.4 Delete block

Delete block
SAMPLE 023
Confirm --> [mode]
Cancel --> [operate]

This function deletes the current block.

10.2.5 Delete measurement

This function deletes the last measurement value.

10.3 Continuous

Main menu

- ▶ Mode
- ▶ Continuous



You can use this function to perform up to 99 measurements at an adjustable measurement interval. This is helpful when you are covering large samples and you want to evaluate the homogeneity of the surface.

Activate Continuous under Mode from the Main menu.

A screen appears for starting a new sequence.

▶	20°	54.7
	60°	81.6
	85°	90.3

To start the measurement, press operate. The unit now performs measurements up to 99 times at the set interval. Measurement values are shown in the display after each measurement.

	\bar{x}	n=25/99		
		min	max	
▶	20°	48.9	46.3	50.4
	60°	79.5	75.1	81.5
	85°	85.3	84.9	86.1

You can interrupt the continuous measurement by pressing the operate button (hold it down briefly). The number of measurements, the mean value, the minimum and the maximum appear in the display. The Pause symbol on the left side indicates that you can continue the sequence, therefore press the operate button.

	\bar{x}	n=25/99		
		min	max	
□	20°	48.9	46.3	50.4
	60°	79.5	75.1	81.5
	85°	85.3	84.9	86.1

To end the sequence, press mode.

For starting a new sequence, press operate again

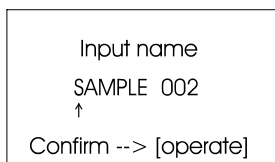

If saving is activated, a screen appears at start of a new sequence, which allows to enter a sample name.

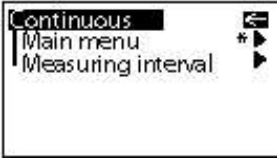

The measuring interval can be changed before a sequence is started. Therefore press the mode wheel to open the Continuous submenu.

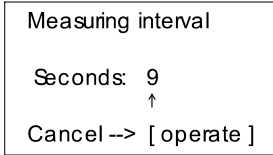

The longest measurement interval possible is 9 seconds, the shortest 0 seconds for continuous measuring.

10.4 Basic mode



The selection options are limited to the most essential in Basic mode. This also greatly simplifies operation in this mode.

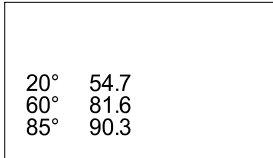

You can select geometry and perform calibration. In addition, all functions in the Setup menu item are available.

Basic mode is useful if you want to interrupt a series of measurements and quickly perform some other measurements in the middle without leaving the series of measurements.

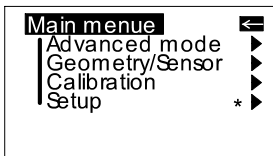

Once these other measurements are complete, you can use

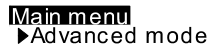

to return to the point where you interrupted the series of measurements.

11 Geometry

Main menu
▶ Geometry

In this menu, you can select the geometry for the gloss measurement.

11.1 Geometry selection

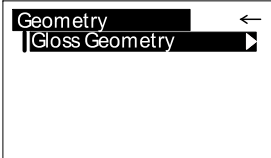

Choose Gloss Geometry from the Geometry menu.

You can choose between the representation of one, two or all three geometries in the display.

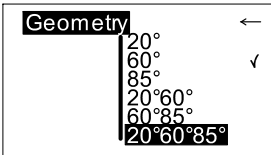

The currently set angle combination is indicated in the Geometry menu by a check mark.

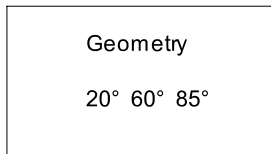

Select the desired combination with the scroll wheel and then confirm by pressing mode.

When Save is turned on, switching the geometry automatically causes the program to switch to the appropriate predefined area of memory.

12. Memory

Main menu

►Memory

To save measurement values, you must activate the Memory function before measuring or else select or create a memory. Up to 999 measurements can be stored. A fixed memory area is already created for each geometry or combination (e.g. M60°). These memory areas cannot be deleted. A total of 50 memory areas can be created.

The Memory function can be used for sample mode, Statistics and Continuous measurements. The layout of the memory is such that the measurement mode and the standard can be changed within a memory area, but not the geometry.

12.1 Memory

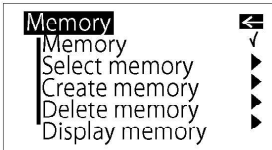

You can use this function to turn saving on or off. A check mark indicates if the function has been activated.

Turning on Memory automatically selects the area in memory that is predefined for the currently set geometry (for example M20°60°).

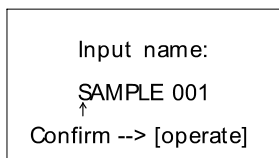

When you press operate to start a reading, you are asked to enter a name for this memory.

12.2 Select memory

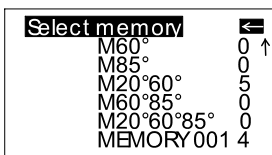

All available areas of memory are listed in this menu, beginning with the one that is predefined.

The number of measurements saved for each area in memory is shown on the right.

Select the appropriate memory area with the scroll wheel and activate the selection by pressing mode.

This automatically turns on Save and switches the geometry if necessary (if the selected memory area is defined for other geometries than what was previously set).

12.3 Create memory

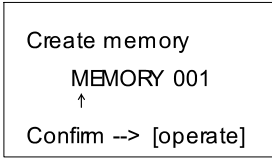

Users can set up their own memory areas with this function. Select the required geometry before you activate this function. Then you must enter the name of a memory area. You can confirm the suggested name directly with the operate button or change it with the scroll wheel. After you confirm, Save is automatically turned on.

12.4 Delete memory

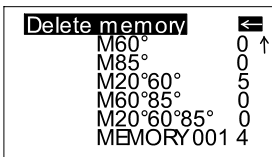

This menu lists all memory areas that have been created with the number of values stored in each one.

Use the scroll wheel to move the mark to the memory area you would like to delete and press the wheel.



A menu appears in which you can decide whether you would like to delete just the content of the memory area or the entire memory area.

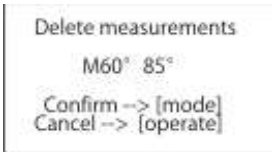

For pre-defined memory areas, you can only delete the measurement values.

12.5 Display memory

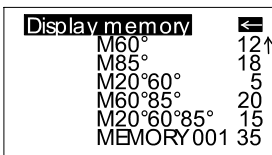

You can transfer data that has been saved to a PC via the interface. The values can also be shown in the display at any time.

The "Display memory" function opens a menu in which all memory areas that have been created are listed. Select the desired area of memory with the scroll wheel.

M20°	60°	SAMPLE005
20°	45.1	
60°	72.3	

The values of the first measurement appear in the display. The sample name is displayed in the highlighted field.

M20°	60°	SAMPLE008
20°	47.2	
60°	76.1	

Turning the wheel switches the display to the next sample with its corresponding values.

Which values are displayed in the columns (for example mean value, min., max.) depends on the display currently selected for Statistics.

13. Difference measurement and Pass/Fail

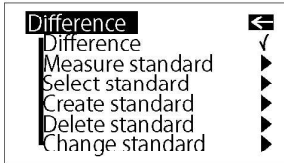

You can compare the readings of samples with the value of a previously measured or saved standard. For saved standards, you can also display whether the test specimen falls within the limits (Pass) or outside (Fail).

Up to 50 standards can be saved. They are stored in a separate area of memory. For each geometry you can determine:

- A target value
- Maximum and minimum for Pass/Fail, see Create standard or Change standard.

13.1 Difference

You can use this menu option to turn Difference measurement on or off. A check mark indicates if the function is active.

When you turn on Difference, the last standard to be used is automatically selected.

If no standard is available, choose the function "Measure standard" or "Create standard" to continue.

13.2 Measure standard

We recommend to perform several readings on the standard with Statistics turned on.

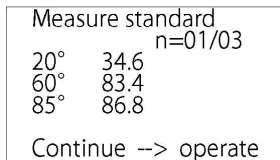

Memory must be activated to store the measured standard. Otherwise it will be temporary hold until another standard is measured.

Activate "Measure standard" and perform the measurement with operate. With memory on, a window appears after the last reading where you can enter the standard's name.

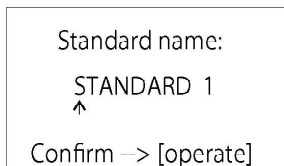

If you inadvertently select a name that has already been used, a message will appear in the display and the arrow will jump back to the first position of the name.

The measured standard values are saved as the target values. At the same time, Difference measurement is turned on and the measured standard is activated. If you want to define limit values additionally, you can use the “Change standard” function.

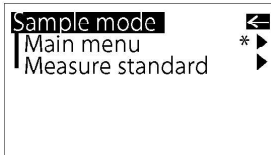

For measuring the samples continue by pressing operate. The display shows the sample values and difference to the target.

The Measure standard function can also be reached directly from the measurement screen by pressing mode.

If you want to compare samples without saving the standard, use the Difference mode with Memory switched off. A measured standard will be kept temporary then, until you measure another one.

13.3 Select standard



To select an existing standard, use the arrow to move the mark to Select standard and then press the wheel.

Standard	Val.	Min	Max
20°	45.0	40.0	50.0
60°	80.0	80.0	90.0
85°	0.0	0.0	2000

The first standard appears in the display. The target value, minimum and maximum are displayed. For values that are not defined, 0.0 or 2000 is displayed. The name of the standard appears inverted at the top right.

Turning the scroll wheel causes the next standard to be displayed.

When you have selected the desired standard in the display, activate it by pressing on the wheel.



A reference to the selected data will appear in the display.

To start Difference measurement press “operate”.

13.4 Create standard

Main menu

- ▶ Difference
 - ▶ Create standard

Standard name:
STANDARD 1
↑
Confirm --> [operate]

Standards can also be saved by entering the target and limit values with the scroll wheel. Move the mark to “Create standard” and activate the function.

A display appears in which you must assign a name for the new standard. If you inadvertently select a name that has already been used, a message will appear to this effect and the marker arrow will jump back to the first position of the name. Confirm the name with the operate button.

In the next step you can define the target and limit values of your standard.

Define standard

Define standard
20°
60°
85°

With the three angle device, a menu first appears in which you can select the geometry.

Define standard
Target value
Minimum
Maximum

After that, the menu appears for selecting the target value, minimum and maximum.

Select the desired variable and press on the scroll wheel.

Define standard
STANDARD 5
Value 20° 0000.0
↑
Cancel --> [operate]

Now you can adjust the corresponding value.

After the last number is activated, the display jumps back to the previous menu.

In this manner you can enter additional target and/or limit values for the standard one after the other if need be. After the entries are complete, Difference measurement is turned on with the new standard.

13.5 Change standard



You can use this function to change target values and limit values of saved standards. You can also use it to define limit values subsequently (for example for a measured standard). Use the scroll wheel to move the mark to Change standard and press the wheel.

All standards are listed one after the other in the following menu. Select the desired standard and press the scroll wheel.

In the next step you can define the target and limit values as described above.

13.6 Delete standard

Use the selection wheel to move the mark to Delete standard in the Difference menu and then press the wheel.



The Delete standard menu appears. All saved standards are listed in this menu.

If there are more standards than can be shown in the display, arrows on the right edge of the display will point to additional standards.

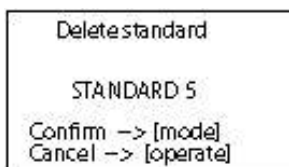

Use the scroll wheel to move the mark to the desired standard and press the wheel.

The standard to be deleted is listed again in the display. Confirm by pressing the mode scroll wheel.

The unit then reverts to the previous menu.

14. Setup

Main menu
▶ Setup

You can make general settings in the Setup menu, for example Language or Display time.

14.2 Date/Time

```
Date/Time
03.03.16 11:45:37
↑
Confirm -->[operate]
```

The unit contains an integrated clock. This makes the date and time of the measurement available for data transfer to a PC. The date and time are not lost even when the battery is changed. If you would like to change the time setting, use the scroll wheel to move the mark to Date/Time and then press mode. The display for setting the date and time appears.

14.3 Beeper

You can use this menu option to turn the beeper on or off. Use the scroll wheel to move the mark to Beeper and press the wheel.

When the beeper is turned on, a check mark appears at the end of the line.

14.4 Display time

```
Display time
Seconds: 25
↑
Cancel ---> [operate]
```

To save electricity, the unit automatically turns off after a certain amount of time. You can determine this time yourself with Display time.

14.5 Language



You can use this menu to select the display language.

Use the scroll wheel to move the mark to the desired language and press the wheel.

14.6 Info

Info	
Catalog no.	4563
Serial no.	1000000
Version no.	V.13.00
Last calib.	03/24/16
Last certif.	01/20/16

You can use this menu option to find the following information:

- Catalog No.
- Serial No.
- Version number of the firmware
- Date of the last calibration
- Date of the last certification

15. Interface

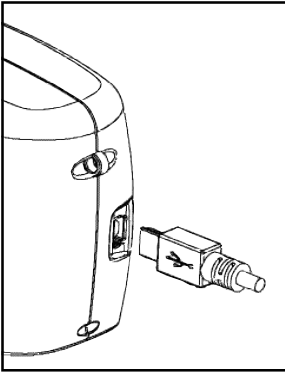

The measurement device is equipped with a USB interface that allows direct communication with a PC.

For data transfer use the USB cable included with delivery. Measurement data can be transferred into the gloss software, which is available for download from the support section of the instrument suppliers website. The data are displayed immediately in a test report with trend graph.

16. Standards

ISO 2813	Paints and varnishes - Determination of specular gloss of non-metallic paint films at 20°, 60° and 85°
ASTM D 523	Standard Test Method for Specular Gloss
ASTM D 2457	Standard Test Method for Specular Gloss of Plastic Films and Solid Plastics
DIN 67530	Reflektometer als Hilfsmittel zur Glanzbeurteilung an ebenen Anstrich- und Kunststoffoberflächen (Reflectometer as a means for gloss assessment of plane surfaces of paint coatings and plastics)
JIS Z 8741	Method of Measurement for Specular Glossiness
ISO 7668	Anodized aluminium and aluminium alloys - Measurement of specular reflectance and specular gloss at angles of 20°, 45°, 60° or 85°.

17. Specifications

Model	MULTI GLOSS 268A	UNI GLOSS 60A UNI GLOSS 60CT UNI GLOSS 60S
Measurement geometry	20°, 60°, 85°	60°
Size of measurement spot	20°: 10 x 10mm 60°: 9 x 15mm 85°: 5 x 38mm	60°A, CT: 9 x 15mm 60°S: 2 x 4mm
Standard compliance	ISO 2813, ASTM D 523, ASTM D 2457, DIN 67 530 and ISO 7668, JIS Z 8741 (excluding 60° S)	
Measurement range	20°: 0.0 ~2,000 GU 60°: 0.0 ~1,000 GU 85°: 0.0 ~ 160 GU	60°: 0.0 ~1,000 GU
Resolution	0 ~99.9 GU: 0.1 GU 100~2 000 GU: 1 GU	
Repeatability	0.0~99.9 GU: 0.2 GU 100~2,000 GU: 0.2% of reading 60°CT: 0~19.9 GU: 0.1 GU	
Inter-instrument agreement	0.0~99.9 GU: 0.5 GU 100~2,000 GU: 0.5% of reading 60°CT: 0~19.9 GU: 0.2 GU	
Memory	999 measurements with date and time	
Difference measurement	Memory for 50 standards	
Battery performance	Approx. 4,000 measurements (when using 1.5 V AA(R6) size alkaline battery)	
Measurement time	0.5 seconds / geometry	
Auto power off	10~99 seconds selectable	
Languages	English, Spanish, German, French, Italian, Japanese, Russian, Polish, Portuguese, Turkish	
Measurement mode	Normal mode (Sample mode, Statistics, Continuous, Basic mode), Difference mode	
Interface	USB 2.0	
Operation temperature/humidity range	15 to 40°C relative humidity max. 85% (at 35°C) with no condensation	
Storage temperature/humidity range	-10 to 60°C relative humidity max. 85% (at 35°C) with no condensation	
Power	1.5 V AA(R6) size alkaline battery, or via USB-port of PC	
Size	155(W) × 73(H) × 48(D) mm	
Weight	400 g	

18. Accessories

Model	MULTI GLOSS 268A	UNI GLOSS 60A UNI GLOSS 60CT UNI GLOSS 60S
Standard accessories	Calibration holder TRI (High gloss tile)	Calibration holder 60°A Calibration holder 60°CT Calibration holder 60°S (High gloss tile)
	USB-cable	
	Carrying case	
	Gloss Data Software (Downloadable from internet; 2 licenses)	
	1.5 V AA(R6) size alkaline battery	
Optional accessories	Checking standard TRI (High and 3 semi gloss tiles 20, 60, 85°)	Checking standard 60°A Checking standard 60°CT Checking standard 60°S (High and semi gloss tile)
	Checking standard Mirror (High and 3 semi gloss tiles 20, 60, 85°)	

Note: The accessories described in this document are subject to change without notice.

19. Errors and warning messages

Memory full	Transfer the content of memory to a PC and then delete the contents of memory.
Reference memory full	A maximum of 50 references can be saved. It may be necessary to delete old references.

You will also find an error number for the following messages in the Calibration/Status menu to provide support for diagnostics:

Tolerance Error 01	Generally occurs only with major changes in climatic or weather conditions. The deviation was successfully compensated for by calibration and correct measurements are still possible. You should still recalibrate the device as soon as it is operating in normal climatic conditions again. However if a change in climate cannot be considered as the cause of the problem, you should check whether the standard is clean.
Please call Service	Autodiagnosis has determined an impermissible Service (invalid) deviation in the measurement signal that cannot be remedied by recalibrating.
Error 02	Generally occurs when there is a significant amount of dirt or dust on the standard or optics. First try to clean the standard. You should only have the optics cleaned by our Customer Service department, for example as part of a yearly recertification.
Error 03	Defect in the electronics or operating error. First check whether the standard is clean and whether the device is properly snapped into the holder.
Error 04	Defect in the lamp or electronics.
Error 05	Defect in the electronics.

Please observe the instructions on cleaning standards in the section on Calibration.

Fluctuations in measurement values

Was the same point on the sample used for all measurements?



Yes. It may help to test the calibration with an additional standard if one is available.



Calibration correct:

Is the test surface completely even and does the measuring device have good contact with the sample?



Yes: Device defective

→ **No.** Check how high the deviations are on the sample itself.

→ **Calibration not correct:**
Recalibrate and clean the standard if necessary.

→ **No:**
In this case, major deviations are possible.

→ Please contact our Customer Service department.

Do not attempt to make any repairs yourself! If a malfunction occurs on your measuring device, our Customer Service department will be happy to help you as quickly as possible.

20. Cleaning and maintenance



- Do not insert any objects into the measurement aperture for cleaning. The instrument could get damaged - affecting a proper and safe operation.



- The instrument housing is resistant to a number of solvents, but cannot be guaranteed to withstand all chemicals. You should therefore use a soft, moist cloth for cleaning. For cleaning excessive dirt, use ethanol or cleaning alcohol. **Do not use any acetone!**



- **Cleaning standards**

The accuracy of the measurement can be significantly impacted by using dirty or damaged standards.

Since the surfaces of the standards are highly sensitive, cleaning must be undertaken with great care.

To clean standards, use a new lint-free cloth, dust-free lens paper or an optical cloth.

Apply only slight pressure as you clean and make certain there are no large particles stuck in the cloth that could damage the surface. **Do not use any acetone!**

For dirt that is difficult to remove, use an optical cloth dipped in liquid. Then wipe the surface with a dry optical cloth.

Exact calibration is not possible unless the standard is in perfect condition. If the condition of the standard seems doubtful because of its appearance or measurement errors, we will be happy to check it for you.

21. Copyright

This instruction manual is an important part of this instrument. It contains essential information about setting up, placing in service and use. If you pass the device on to another user, please ensure that the instruction manual is included with the instrument. The manual must be studied carefully before working with the equipment. Please contact your regional service office if you have any questions or require additional information about the device.

The technology and fittings are based on state-of-the art optic and electronic technology. New developments and innovations are constantly being integrated into the equipment. Thus, the diagrams, dimensions, and technical data used in this manual may have changed as a result of adapting the device to new information and improvements.

© Copyright 2016
All rights reserved

No portion of the software, documentation or other accompanying materials may be translated, modified, reproduced, copied or otherwise duplicated (with the exception of a backup copy), or distributed to a third party, without prior written authorization from the manufacturer. In any case, this requires the prior written consent of the manufacturer.

The manufacturer offers no guarantee that the software will function without error or that the functions incorporated therein can be executed in all applications and combinations selected by you.

No liability other than as provided by law is assumed for direct or indirect damage sustained in association with the use of the instrument, the software or documentation.

The manufacturer reserves the right to update the software and written documentation without prior notice.

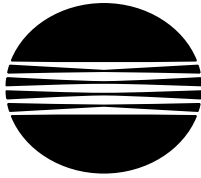

KONICA MINOLTA

260 023 933 E 1609