

# ILLUMINANCE METER T-10A/T-10MA

## INSTRUCTION MANUAL



Before using this instrument,  
please read this manual.



KONICA MINOLTA

# Safety Symbols

The following symbols are used in this manual to prevent accidents which may occur as result of incorrect use of the instrument.



Denotes a sentence regarding a safety warning or note.  
Read the sentence carefully to ensure safe and correct use.



Denotes a prohibited operation.  
The operation must never be performed.



Denotes an instruction.  
The instruction must be strictly adhered to.



Denotes an instruction.  
Disconnect the AC adapter from the AC outlet.



Denotes a prohibited operation.  
Never disassemble the instrument.



This symbol indicates A.C.



This symbol indicates D.C.



This symbol indicates class II protection against electric shock.

## STATEMENT OF FCC COMPLIANCE

This device complies with Part 15 of the FCC Rules. Operation is subject to the following two conditions: (1) This device may not cause harmful interference, and (2) this device must accept any interference received, including interference that may cause undesired operation. Change or modifications not approved by the party responsible for compliance could void the user's authority to operate the equipment. This equipment has been tested and found to comply with the limits for a Class B digital device, pursuant to Part 15 of the FCC Rules. These limits are designed to provide reasonable protection against harmful interference in a residential installation. This equipment generates, uses and can radiate radio frequency energy and, if not installed and used in accordance with the instructions, may cause harmful interference to radio communications. However, there is no guarantee that interference will not occur in a particular installation. If this equipment does cause harmful interference to radio or television reception, which can be determined by turning the equipment off and on, the user is encouraged to try to correct the interference by one or more of the following measures:

Reorient or relocate the receiving antenna.

Increase the separation between the equipment and receiver.

Connect the equipment into an outlet on a circuit different from that to which the receiver is connected.



















Consult the dealer or an experienced radio/TV technician for help.

This Class B digital apparatus complies with Canadian ICES-003.

Cet appareil numérique de la classe B est conforme à la norme NMB-003 du Canada.

# **SAFETY PRECAUTIONS**

To ensure correct use of this instrument, read the following points carefully and adhere to them. After you have read this manual, keep it in a safe place where it can be referred to anytime a question arises.

 <b>WARNING</b> (Failure to adhere to the following points may result in death or serious injury.)	
 Do not use the instrument in places where flammable or combustible gases (gasoline fumes etc.) are present. Doing so may cause a fire.	 Do not disassemble or modify the instrument or the AC adapter. Doing so may cause a fire or electric shock.
 Always use the specified AC adapter (100 to 240 V ~ 50/60 Hz; North America or Taiwan:100 to 120V, Japan:100V) and conforms to national regulations plugged into an indoor outlet of the rated voltage. If an AC adapter other than those specified by KONICA MINOLTA is used, or if the adapter is connected to an unsupported voltage, it may result in damage to the adapter, fire, or electric shock.	 The instrument should not be operated if it is damaged or AC adapter is damaged, or if smoke or odd smells occur. Doing so may result in a fire. In such situations, turn the power OFF immediately, remove the batteries (or disconnect the AC adapter from the AC outlet), and contact the nearest Konica Minolta-authorized service facility.
 If the instrument will not be used for a long time, disconnect the AC adapter from the AC outlet. Accumulated dirt or water on the prongs of the AC power cord's plug may cause a fire and should be removed.	 Do not put the batteries on a fire, charge them (if they are not chargeable), short-circuit them, heat them or disassemble them. Doing so may cause an explosion or heat generation, resulting in fire or injury.
 Take special care not to allow liquid or metal objects to enter the instrument. Doing so may cause a fire or electric shock. Should liquid or metal objects enter the instrument, turn the power OFF immediately, remove the batteries (or disconnect the AC adapter from the AC outlet), and contact the nearest Konica Minolta-authorized service facility.	 Should liquid leak from batteries and contact to eye, wash liquid off with clean water without rubbing eyes and immediately seek for medical professional's advice. In case liquid contacts with hand or clothes, wipe it off with plenty of water. Avoid further use of such unit.
 Do not forcibly bend, twist or pull the power cord. Do not place heavy objects on, or damage or modify the power cord. Doing so may damage the power cord and cause fire or electric shock.	 Dispose of batteries used in the instrument correctly. Disposing of batteries incorrectly may result in heat generation or cause batteries to catch fire due to short circuiting. This may result in a fire, injury, or burns. Disposal methods for batteries may vary according to where you live. Dispose of batteries in accordance with local regulations or through a registered waste disposal agency.
 Always disconnect the power cord by holding the power plug. Pulling the power cord itself may damage it and cause fire or electric shock. Do not insert or disconnect the power cord plug with wet hands. Doing so may cause electric shock.	
 Insert the power plug fully and securely. Incomplete inserting may cause fire or electric shock.	 Do not touch or hold the batteries with wet hands. Doing so may cause electric shock or failure.
 <b>CAUTION</b> (Falling to adhere to the following points may result in injury or damage to the instrument or other property.)	
 Do not use batteries other than those specified by KONICA MINOLTA. When installing batteries in the instrument, make sure that they are correctly oriented according to the (+) and (-) marks. Also make sure not to mix new and old batteries, or mix batteries of different types. Failure to adhere to these instructions may cause batteries to explode or leakage of electrolyte, resulting in fire, injury or air pollution.	
 The socket-outlet shall be installed near the machine and shall be easily accessible.	 When cleaning, disconnect the power plug. Connecting may cause electric shock.

## Notes on Use

**Be sure to use this instrument properly. Use of this instrument in ways other than those specified in this manual may result in risk of injury, electric shock, instrument damage, or other problems.**

- This is a precision instrument, and should be handled with due care.
- Read through this manual before powering up this instrument for the first time.
- Always set the power switch to OFF position (the "O" side) before attaching or removing the receptor head.
- To conserve batteries, keep the power switch set to the OFF position while the instrument is not in use.
- Take care to keep the receptor window clean and free of scratches. Keep the cap on when the window is not in use.
- Do not press or push on the display, or subject the display to impacts or other excessive forces.
- This instrument should be used in an environment with an ambient temperature between -10°C and 40°C and maximum relative humidity 85% for temperatures up to 35°C decreasing linearly to 66% relative humidity at 40°C with no condensation. Use of the instrument outside this range will result in unsatisfactory performance.
- Keep in mind that the instrument may become considerably hotter than the surrounding environment if left under direct sunlight or near a heater or other such device. Exercise due care when using the instrument in these types of locations.
- The receptor of T-10A or mini receptor of T-10MA is not compatible with existing model T-10 or T-10M.
- Use a commercially available 10Base-T network cable (category 5 straight cable). The cable can be extended up to 50 meters. Using a cross cable will disable the instrument and may cause malfunction of the connected system.
- If you use the T-10MA and move the cable connecting the main body to the receptor head during measurement, the displayed value may fluctuate. In particular when measuring low illuminance, take care not to allow the cable to move.
- Use an insulated fastener when the T-10MA receptor window or the receptor head code connecting plug is to be attached using a faster. When the T-10MA receptor window or the receptor head code connecting plug is in contact with metals or other materials that conduct electricity, it may not be possible to get correct measurement values.
- Since the instrument uses a microcomputer, strong external magnetic noise may cause malfunction. In this case, remove the batteries (or AC adapter) and then install them (or connect the AC adapter) again to turn the power ON.
- Do not use this instrument at altitudes above 2000 meters (6560 ft).
- This instrument is intended for use in Installation (Overvoltage) Category II. Be sure to use the specified power source when powering this instrument from an AC adapter.

- This instrument complies with Electrical equipment for measurement, control and laboratory use - EMC (Electromagnetic Compatibility) requirements - Part 1: General requirements (EU Harmonized Standards EN 61326-1:2021). Conformity verification is performed under KONICA MINOLTA's test conditions in an INDUSTRIAL ELECTROMAGNETIC ENVIRONMENT specified in the relevant harmonized standards. The limit of performance degradation when subjected to continuous disturbance during immunity testing is up to twice KONICA MINOLTA's repeatability specifications (Ev).
- This instrument is a Pollution degree II product. Avoid use in environments where the instrument may be exposed to metallic dust or condensation.

## How to Clean

- If the instrument gets dirty, wipe it with a dry cloth or silicon cloth. Never use solvents such as thinner and benzene.
- If the receptor window gets very dirty, wipe it gently with a soft dry cloth. If the dirt cannot be removed or the receptor window is scratched, contact the nearest Konica Minolta authorized service facility.
- In cases of malfunction, do not disassemble the CL-200A or attempt to repair it yourself. Contact the nearest Konica Minolta-authorized service facility.

## How to Store

- This instrument should be stored at temperatures of between -20 and 55 °C at 85% or less relative humidity (at 35 °C). Do not store this instrument in hot and humid areas or areas where condensation is likely to occur. For protection, this instrument should be stored at normal temperatures with a drying agent.
- Do not leave the instrument near the rear window or inside the trunk of a car. Under strong sunlight, the increase in temperature can be extreme and may result in breakdown or deformation.
- If you are not going to use the instrument for 2 or more weeks, remove the batteries from the instrument. Failure to do so may cause leakage of electrolyte, resulting in damage to the instrument.
- Do not wind accessory cables and/or receptor head codes (for T-10MA) around the instrument. Doing so may exert excessive force on cable/code connections and/or plugs, resulting in disconnection.

## Disposal Method

- When disposing of used batteries, insulate the terminals with insulating tape etc. If the terminals of the battery come into contact with metal objects, heat generation, explosion or fire may result.
- Make sure that the T-10MA, its accessories and used batteries are either disposed of or recycled correctly in accordance with local laws and regulations.

# Contents

<b>SAFETY PRECAUTIONS</b> .....	<b>1</b>
<b>Contents</b> .....	<b>3</b>
<b>Names and Functions of Parts</b> .....	<b>4</b>
<b>Basic Operations</b>	
<b>Preparation</b> .....	<b>8</b>
Installing the Receptor Head .....	8
Removing the Receptor Head .....	8
Selecting measuring units .....	8
Attaching the Cap .....	8
Putting the Instrument in the Case .....	10
Installing the Batteries .....	11
Turning Power ON .....	11
Zero Adjustment .....	12
Battery Alarm .....	12
Notes on measurement .....	12
<b>Measuring the Illuminance</b> .....	<b>13</b>
Measuring Method .....	13
Over Alert .....	13
<b>Measuring the Illuminance Difference / Ratio</b> .....	<b>14</b>
Entering the Reference Value .....	14
Measuring the Illuminance Difference / Ratio .....	18
<b>Measuring the Integrated Illuminance</b> .....	<b>19</b>
<b>Automatic Integration Stop Function</b> .....	<b>21</b>
Setting Method .....	21
Checking the Setting .....	24
Changing the Setting .....	24
<b>Operating the Instrument with External Power</b> .....	<b>25</b>
Connecting the AC Adapter .....	25
<b>Advanced Operations</b>	
<b>Color Correction Factor (CCF)</b> .....	<b>28</b>
Measurement using the CCF .....	28
CCF Setting Method .....	29
<b>Setting the Range Manually</b> .....	<b>32</b>
Manual/auto measuring ranges .....	32
Setting Method .....	32
Over-range Error .....	33
<b>Recording the Measured Illuminance Continuously (Analog Output)</b> .....	<b>34</b>
<b>Printing the Measured Data (Digital Output)</b> .....	<b>36</b>
Printer Requirements .....	36
Example of recommended printer .....	36
Procedure .....	36
Print example .....	37
<b>Connecting to a PC</b> .....	<b>38</b>
<b>Separating the Receptor Head from the Main Body</b> .....	<b>39</b>
Items Required .....	39
Measuring Method .....	39
Fixing the Receptor Head .....	40
<b>Multi-Point Measurement</b> .....	<b>41</b>
Items Required .....	41
Measuring Method .....	41
<b>Notes on Multi-Point Measurement</b> .....	<b>44</b>
<b>Accessories</b>	
<b>Standard Accessories</b> .....	<b>46</b>
<b>Optional Accessories</b> .....	<b>46</b>
<b>System Diagram</b> .....	<b>48</b>
<b>Explanation</b>	
<b>Error Messages</b> .....	<b>50</b>
<b>Reference Measurement Plane / Dimension Diagram</b> .....	<b>51</b>
<b>Relative Spectral Response</b> .....	<b>52</b>
<b>Cosine Correction Characteristics</b> .....	<b>54</b>

# Names and Functions of Parts

## T-10A

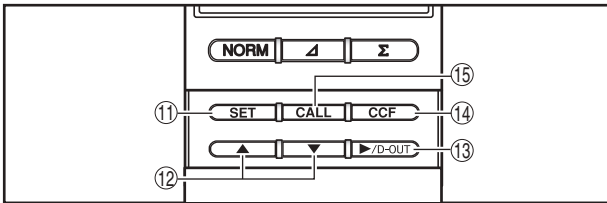
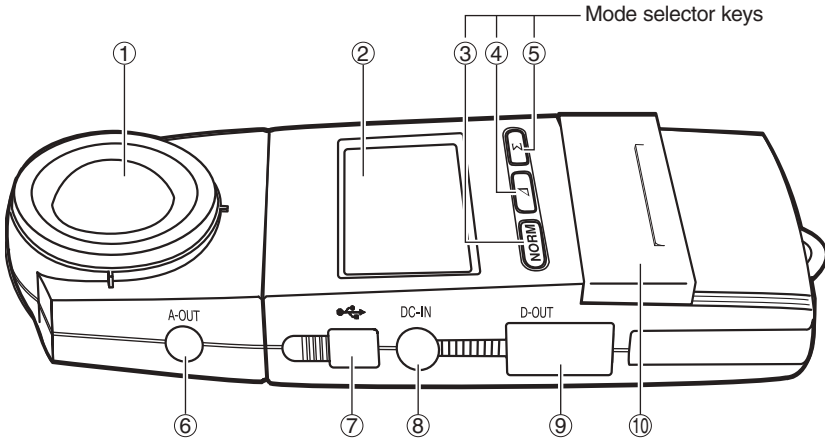

▲ When the slide cover is open

① Receptor Window

② Display

Mode selector keys

③ **[NORM]** key ..... Switches to normal illuminance measurement mode.

④ **[Δ]** key ..... Switches to illuminance difference/ratio measurement mode, and switches the displayed value between the illuminance difference and ratio.

⑤ **[Σ]** key ..... Switches to integrated illuminance measurement mode and displays the measured integrated illuminance.

⑥ Analog output terminal ..... Outputs an analog signal to a recorder etc.

⑦ USB terminal ..... Use to connect this instrument to a PC using USB cable T-A15, a standard accessory.

⑧ AC adapter terminal ..... Connect the optional AC adapter (AC-A412) to this terminal.

⑨ Printer output terminal ..... Outputs measured data to a printer or other peripheral.

⑩ Slide cover

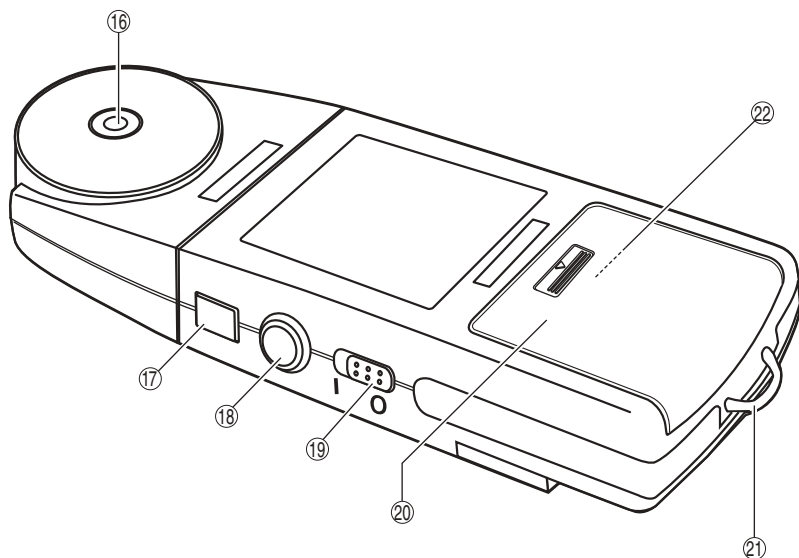

- ⑪ [SET] key ..... • Activates SET mode.  
• Confirms the numeric setting.
- ⑫ [▲][▼] keys ..... Changes the currently set value and decimal point position.
- ⑬ [▶/D-OUT] key ..... In normal mode, this key is used to output data to a personal computer or printer. In SET mode, this key is used to shift from one digit to another when changing the currently set value using the [▲] and [▼] keys.
- ⑭ [CCF] key ..... Sets the color correction factor.
- ⑮ [CALL] key ..... Calls the currently set data.
- ⑯ Tripod fixing screw hole
- ⑰ Receptor head remove button ..... Press this button to detach the receptor head from the main body.
- ⑱ HOLD button
  - RUN state ..... The button is pushed out. Measurement is performed repeatedly.
  - HOLD state ..... The button is pushed in. Measurement is paused and the measured value in effect just before measurement was paused is held. Pushing this button and releasing it again will place the instrument in RUN state.
- ⑲ Power switch
- ⑳ Battery cover
- ㉑ Strap hook
- ㉒ Measuring-unit selector ..... Allows selection of lx or fcd.  
(Screen examples given in this manual are mainly for lx.)  
(Inside the battery chamber, refer to page 8)

# T-10MA

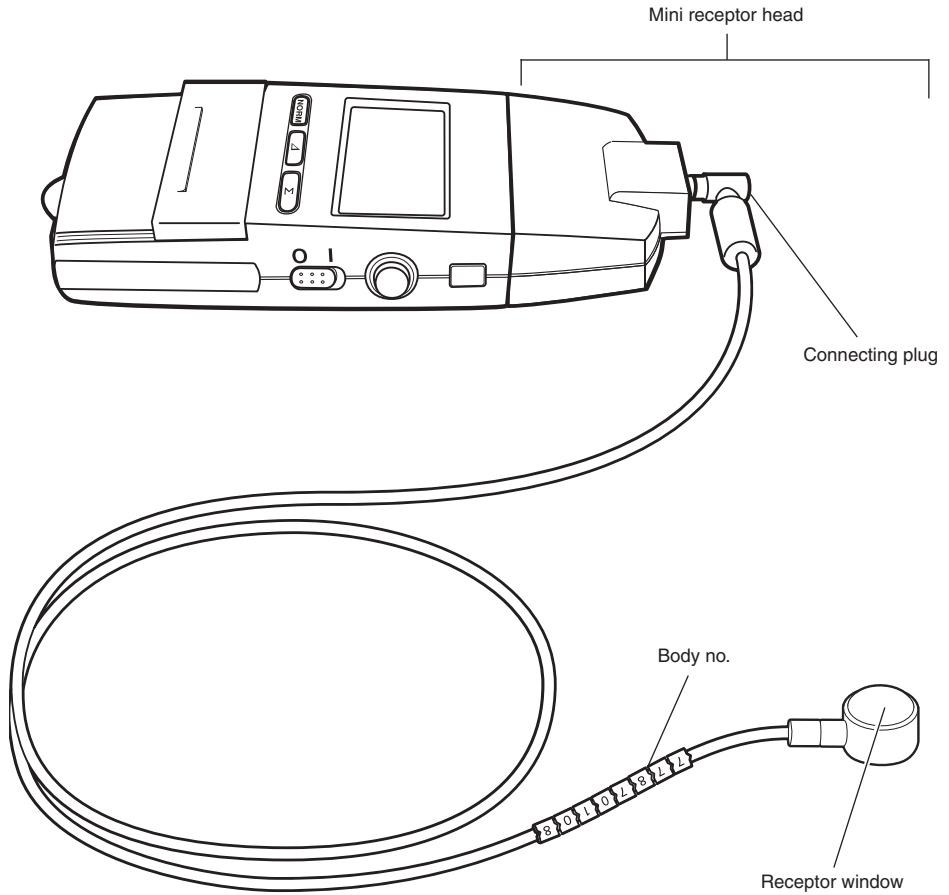

## Notes on T-10MA Body No.

A body No. is indicated in two places as shown below: one on the sensor (receptor head code) and the other on the back of the adapter (main body side).

When using two or more T-10MA (mini receptor head) units, make sure that the body no. on each sensor matches the one on the corresponding adapter.

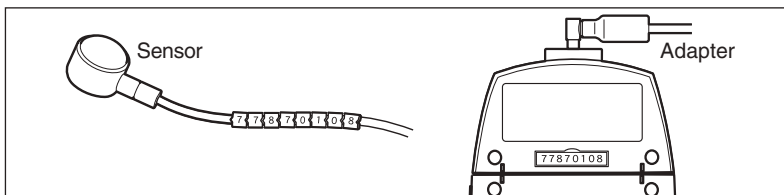



# ***Basic Operations***

---

# Preparation

## Installing the Receptor Head

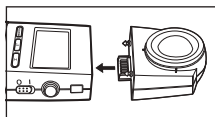

- 1 Attach the receptor head (Mini receptor head in the case of T-10MA) to the main body.

▼For T-10MA

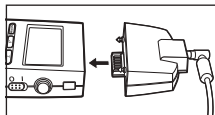

## Removing the Receptor Head

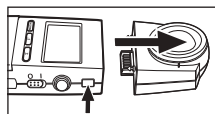

- 1 Hold down the receptor head remove button, then pull out the receptor head (Mini receptor head in the case of T-10MA) from the main body.

▼For T-10MA

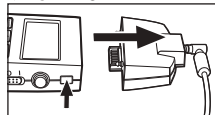

- Always set the power switch to the OFF position (the “○” side) before attaching or removing the receptor head. Attaching or removing the head while the power is ON may generate an error.

## Selecting measuring units

The Konica Minolta Illuminance Meter allows you to take readings in either Lux (lx.) or Foot-candle (fcd) units.

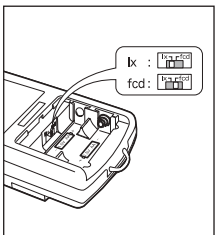

- 1 Set the power switch to “○” (OFF), and pull the battery cover while pressing it down slightly.
- 2 Remove two AA-size batteries, if it exits.
- 3 Set the measuring-unit selector to the desired position (lx. or fcd).
- 4 Pull back those batteries and battery cover.

## Attaching the Cap

■For T-10A

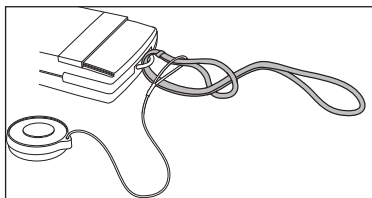

When attaching the strap to the main body, attach the cap to the strap as shown below.

- 1 Pass the strap through the string extended from the cap, then attach the strap to the main body.

If the strap is not to be used, install the cap using the procedure as shown below.

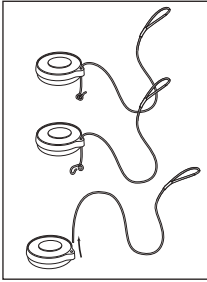

**1** Untie the strap attached to the cap, and remove the strap from the cap.

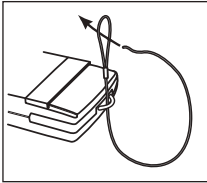

**2** Attach the strap to the strap hook as shown.

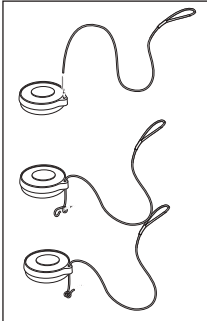

**3** Pass the strap through the cap, and knot the end of the strap so that it does not become detached from the cap.

■ **For T-10MA**

Install the cap using the procedure as shown below.

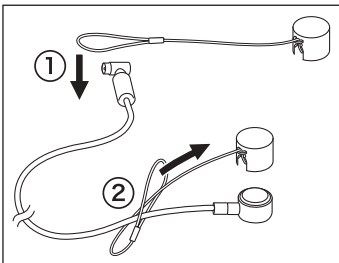

**1** Pass the loop-end of the strap attached to the mini cap from the connecting plug side of the cable, and fasten it to the cable as shown.

## Putting the Instrument in the Case

### ■For T-10A

Attach the cap to the receptor window and put the instrument into the case.

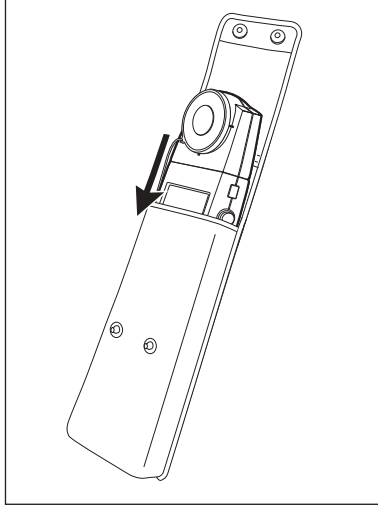

### ■For T-10MA

Remove the sensor plug from the mini receptor head, put the instrument into the case, then put the sensor into the pocket of the case.

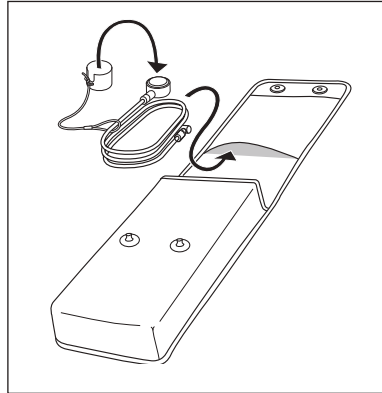
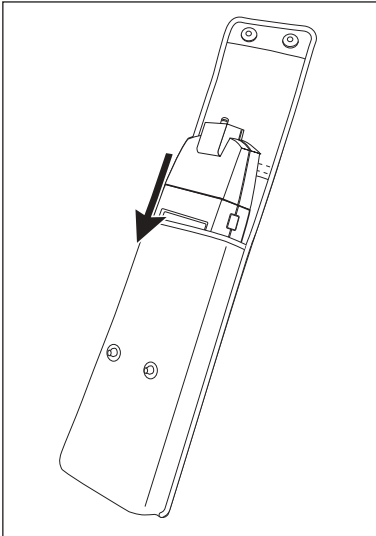

## Installing the Batteries

### ⚠ WARNING

- ⊘ Do not allow batteries to come into contact with fire, and do not charge them (unless they are specifically designated as rechargeable), heat them, or take them apart. Any of these actions may cause batteries to overheat or explode, possibly resulting in fire or injury.

### ⚠ CAUTION

- ⊘ Do not use battery types that are not specified for this instrument. Never mix old and new batteries, or different types of batteries. Be sure to load batteries with the (+) and (-) polarities in the correct direction. Neglecting any of these precautions may result in battery leakage or explosion, possibly resulting in fire, injury, or environmental damage.

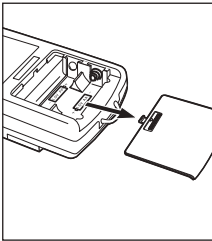

- 1** Set the power switch to “O” (OFF), and pull the battery cover as shown while pressing it down slightly.

- Have two AA-size batteries ready.

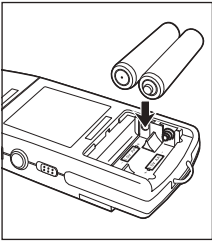

- 2** Install the batteries in the correct direction, then put the cover on.

## Turning Power ON

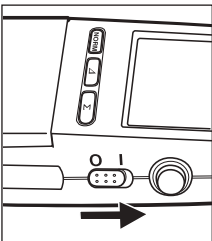

- 1** Set the power switch to “I” (ON).

- Setting the power switch to “I” (ON) with the hold button pushed out (RUN) will start measurement immediately.
- Setting the power switch to “I” (ON) with the hold button pushed in (HOLD) will not start measurement. To start measurement, the hold button needs to be pushed out (RUN).

## Zero Adjustment

Zero adjustment is performed automatically when the power switch is set to "I" (ON).

- "CAL" (calibration) will be displayed in the display section during zero adjustment.
- Zero adjustment is performed electrically, so no cap is required.
- When zero adjustment is complete, "CAL" will disappear and "0 lx (0.0 fcd)" will appear (if the hold button is pushed in (HOLD)).

## Battery Alarm



When batteries start to run low, a battery mark appears above the measurements on the display. When the batteries become very low, the battery mark will begin to blink. Make new batteries available. If you still continue to use the batteries, the display will blank before long, indicating measurement is no longer possible. Replace the batteries to restore normal operation.

- Fresh alkaline batteries should provide enough power approx. 72 hours of continuous measurements (at room temperature).  
When replacing batteries: Remove both of the old batteries first, and then install the new batteries.

## Notes on measurement

- Existing models T-10 and T-10M have a response speed selector switch that allows you select the response speed between FAST (90% response time: 1 ms) and SLOW (90% response time: 1 s) depending on the target light source. But this model does not have such a switch with the 90% response time being fixed to 28 ms.
- This instrument is capable of measuring a light source with fluctuations in light amount (luminous energy) such as a light source dimmed by pulse width modulation (PWM) signals. But the use of this instrument for measuring a light source with a low-frequency (less than 50 Hz) fluctuation may yield measurement errors.
- Select an appropriate range manually (see page 24) in the following cases. The selected range is appropriate when bringing the receptor close to or away from the light source changes the readout.
- When you want to measure a noncontiguous light:
- Measuring such a light may freeze the readout. This is because the peak illuminance of the light source is too high so that it exceeds the current measuring range.
- When the fluctuation in light amount is large:
- Measuring a light source whose light amount fluctuates largely near a measuring range switching point may results in errors in calculated intensity of illuminance or MULTI AVG value.
- A momentary measurement error of approx. 0.5% lower than the correct value may occur at regular intervals. This is due to the auto zero calibration feature (activated at intervals of approx. 6 min) of the receptor, and is not a failure.

# Measuring the Illuminance

- When performing measurement, take care not to allow the shadow or reflection of the operator to enter the receptor window.

## Measuring Method

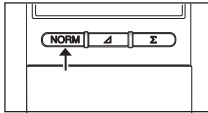

**1** Press the [NORM] key.

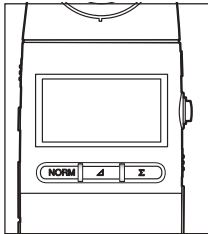

**2** Push out the hold button (RUN).

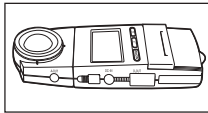

**3** Place the receptor head in the desired measuring position.

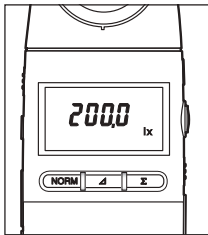

- The spherical summit of the receptor window is used as the reference plane for measurement (see page 28).
- ◆ The illuminance at the measuring position will appear in the display section.
- To hold the measured value, push in the hold button. (The back-light in the displayed section will light up for 10 seconds if the measured value is 10 lx or less.)
- To cancel the hold, push the hold button again and release

## Over Alert



If any of the measured values, X, Y, or Z exceeds 99,990, the display will show a blinking “-0-” in place of the measurement results. For details, see page 50.

# Measuring the Illuminance Difference / Ratio

This section explains how to measure the difference between the measured illuminance and reference illuminance as well as the ratio of the measured illuminance to the reference illuminance.

## Entering the Reference Value

The reference value can be set in the following two ways.

- ① By setting the measured value as the reference value
- ② By entering the desired reference value numerically

### ① Setting the measured value as the reference value

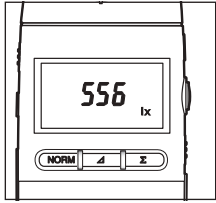

- 1** Operate the instrument as described in “Measuring the Illuminance” (page 11) and display the measured value. If the measured value is satisfactory as the reference value, hold it.

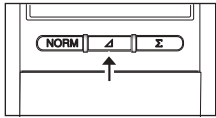

- 2** Press the [ $\Delta$ ] key.

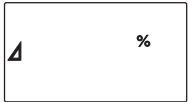

- ◆ “ $\Delta$  lx” or “ $\Delta$  %” will appear in the display section.
- Each time the [ $\Delta$ ] key is pressed, “ $\Delta$  lx” or “ $\Delta$  %” will appear alternately.



- If the reference value had already been set, the difference from the reference value ( $\Delta$  lx) or the ratio to the reference value (%) will appear.



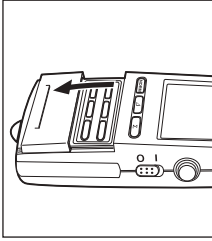

### 3 Open the slide cover and press the [SET] key.

- ◆ The reference value which has been held will blink.
- To cancel the reference value, press the [CALL] key.



### 4 Press the [SET] key again.

- ◆ The reference value will be set, and “± 0 lx” or “100.0 %” will appear.



- To check the reference value, press the [CALL] key. The reference value will be displayed while the [CALL] key is held down.

## ② Entering the desired reference value numerically

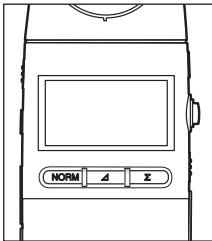

### 1 Operate the instrument as described in “Measuring the illuminance” (page 13). Make sure that the hold button is pushed out (RUN).

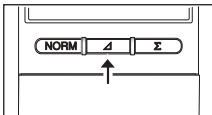

### 2 Press the [Δ] key.

- ◆ The mode will switch to illuminance difference/ratio measurement mode.

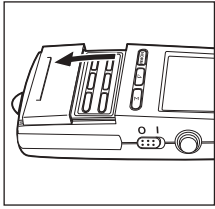

### 3 Open the slide cover and press the [SET] key.

◆ The instrument is now ready for you to enter a value, and one of the following values will appear.



● If no reference value had been set, "00.00" will appear (with the decimal point blinking).



● If the reference value had already been set, it will appear (with the decimal point, "0" or "00" blinking).



● If an integer value (i.e. a value which does not have a decimal point) has been set as the reference value, the three decimal points will blink.

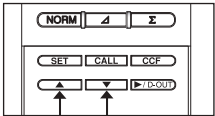

### 4 Select the effective digits of the reference value using the [▲] and [▼] keys.

● The display will change as follows each time the key is pressed.

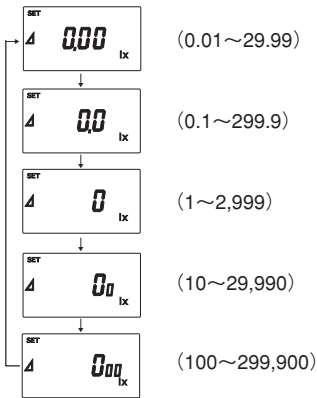

\* In the above example, the [▲] key is pressed to change the display. The display will change in opposite direction if the [▼] key is pressed.

\* Values in ( ) indicate the settable range.

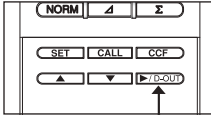

**5** Press the [▶/D-OUT] key to select the digit to be changed.  
The value at the selected digit will blink.

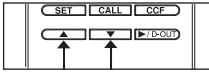

**6** Change the value using the [▲] and [▼] keys.



**7** Repeat steps 5 and 6 to complete entry of the desired reference value.

- To cancel entry of the reference value, press the [CALL] key.

**8** If the entered reference value is satisfactory, press the [SET] key.

- ◆ The reference value will be set, and “±0 Ix” or “100.0 %” will appear.

- To check the entered reference value, press the [CALL] key. The reference value will be displayed while the [CALL] key is held down.

## Measuring the Illuminance Difference / Ratio

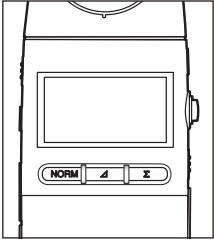

**1** Push out the hold button to switch from HOLD to RUN.

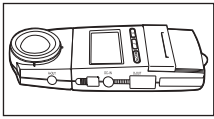

**2** Place the receptor head in the desired measuring position.

- ◆ The measured illuminance difference or ratio will appear.
- Each time the [Δ] key is pressed, the illuminance difference or ratio will appear alternately.

- Example)



← 20 lx brighter than the reference value



← 30 lx darker than the reference value



- The measured illuminance is displayed in a percentage (%), with the reference value set as 100.
- ← 87.4% of the reference value

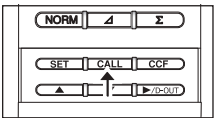

- To check the currently set reference value, press the [CALL] key. The reference value will be displayed while the [CALL] key is held down.

- Once the reference value is set, it will remain effective until it is changed.
- To delete the reference value, carry out the steps described in 2, "Entering the desired reference value numerically" and then enter "0".
- The display range of illuminance difference is from "- reference value" to "maximum display value within the measuring range - reference value".
- The display range of illuminance ratio is from 0.0% to 999.9%. "----" will blink if the illuminance ratio exceeds this range.

# Measuring the Integrated Illuminance

This instrument enables you to measure integrated illuminance (lx·h), integration time (h) and average illuminance (lx).

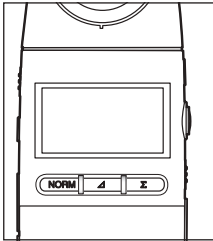

- 1** Set the power switch to “O” (OFF) and push in the hold button (HOLD).

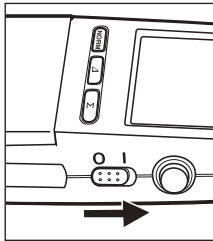

- 2** Set the power switch to “I” (ON).
  - “0 lx” will appear in the display section.

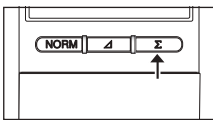

- 3** Press the [Σ] key to switch the mode and make sure that “0.00 lx·h (0.000 fcd·h)” is displayed (or “0.000 h” in the case of integration time display mode).

- 4** Place the receptor head in the desired measuring position.

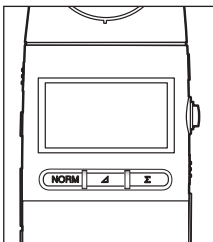

- 5** Push out the hold button (RUN).
  - ◆ Measurement (integration) will start immediately after the hold is canceled (i.e. the hold button is pushed out).
  - Each time the [Σ] key is pressed, the display mode switches from one to another.

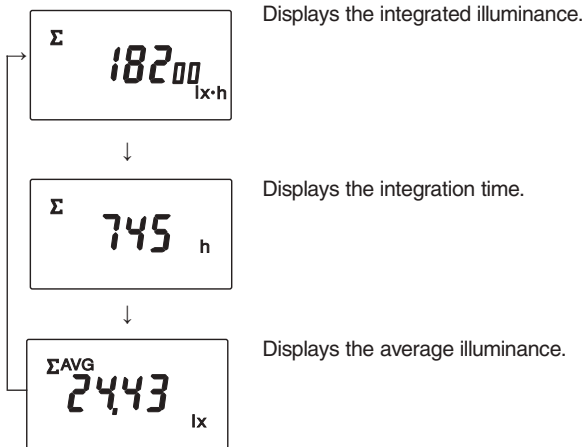

- Integration can be continued even if measurement of illuminance or illuminance difference/ be paused.
- To reset integration, set the power switch to “O” (OFF).
- The maximum measurable value and minimum unit for each display mode are given in the table below.

	Minimum unit	Maximum value
Integrated illuminance	0.01 lx·h (= 36 lx sec) 0.001 fcd·h (= 3.6 fcd·sec)	999,900 x 10 <sup>3</sup> lx·h 99,990 x 10 <sup>3</sup> fcd·h
Integration time	0.001 h (= 3.6 sec)	9,999 h

# Automatic Integration Stop Function

The instrument has a function that stops measurement automatically when the preset integration time or integrated illuminance is reached during measurement of integrated illuminance.

- It is not possible to preset both integration time and integrated illuminance at the same time. The integration time or integrated illuminance, whichever is set last, will be effective.

## Setting Method

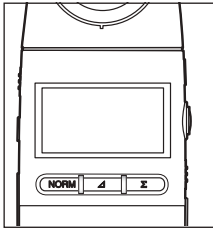

**1** Set the power switch to “O” (OFF) and push in the hold button (HOLD).

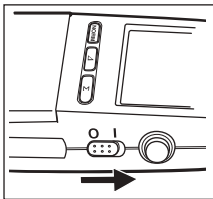

**2** Set the power switch to “I” (ON).

- ◆ “0 lx” will appear in the display section.

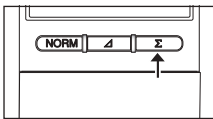

**3** Press the [ $\Sigma$ ] key to switch the mode and make sure that “0.00 lx·h” is displayed (or “0.000 h” in the case of integration time display mode).



▲ Displays the integrated illuminance.



▲ Displays the integration time.

- The measurement unit will switch as shown below.

$\Sigma$ lx·h	→	Integrated illuminance (lx·h)
$\Sigma$ h	}	→ Integration time (h)
$\Sigma$ AVG lx		

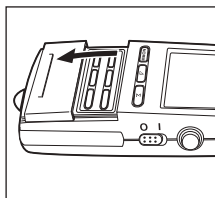

## 4 Open the slide cover and press the [SET] key.

- ◆ The instrument is now ready for you to enter a value, and "00.00" will appear (with the decimal point blinking).
- If the value (integration time or integrated illuminance) had already been set, it will appear (with the decimal point, "0" or "00" blinking).
- If an integer value (i.n. a value which does not have a decimal point) has been set as the reference value, the three decimal points will blink.

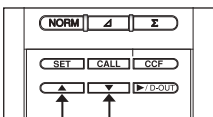
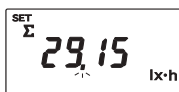

## 5 Select the effective digits of the value using the [▲] and [▼] keys.

- The display will change as follows each time the key is pressed.

### ▼ Integrated illuminance

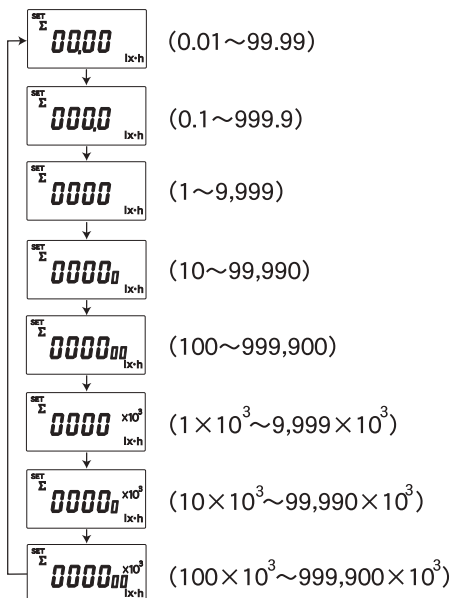



▼ Integration time



\* In the above example, the [▲] key is pressed to change the display. The display will change in opposite direction if the [▼] key is pressed.

\* Values in ( ) indicate the settable range.

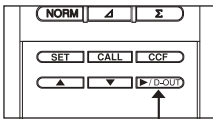

**6** Press the [▶/D-OUT] key to select the digit to be changed.  
The value at the selected digit will blink.

**7** Change the value using the [▲] and [▼] keys.

**8** Repeat steps 6 and 7 to complete entry of the desired value.

- To cancel entry of the value, press the [CALL] key.

**9** If the entered value is satisfactory, press the [SET] key.

- ◆ The value will be set.

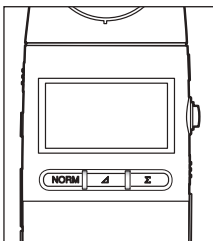

**10** Push out the hold button (RUN).

- ◆ Measurement (integration) will start immediately after the hold is canceled (i.e. the hold button is pushed out).
- ◆ When the preset integration time or integrated illuminance is reached, measurement will stop automatically.



**11** The unit will blink, indicating that measurement is currently paused.

- This also occurs in normal and  $\Delta$  modes.



**12** Set the power switch to “O” (OFF).

- If the power switch is not set to “O” (OFF) to reset the instrument, it will also be impossible to perform measurement in other modes.

## Checking the Setting

- To check the currently set value, press the [CALL] key. The currently set value will be displayed while the [CALL] key is held down.

## Changing the Setting

If you want to change the currently set value while measurement is in progress, carry out steps 4 to 9.

- The value you are going to set must be larger than the currently set value. If a value smaller than currently set value is set, “Err A” will appear, causing the SET mode to be exited.

# Operating the Instrument with External Power

## ⚠ WARNING

- ❗ Always use the AC adapter supplied as an optional accessory, and connect it to an AC outlet of the rated voltage and frequency. Using a non-specified AC adapter or connecting it to an incorrect AC outlet may damage the instrument or AC adapter, causing a fire or electric shock.
- ⚡ If the instrument will not be used for a long time, disconnect the AC adapter from the AC outlet. Accumulated dirt or water on the prongs of the AC power cord's plug may cause a fire and should be removed.
- ❗ The instrument should not be operated if it is damaged or AC adapter is damaged, or if smoke or odd smells occur. Doing so may result in a fire. In such situations, turn the power OFF immediately, remove the batteries (or disconnect the AC adapter from the AC outlet), and contact the nearest Konica Minolta-authorized service facility.

## ⚠ CAUTION

- ❗ The voltage/ampere rating of the AC adapter jack's is 12 V DC / 3 A. The jack's outer polarity is positive (+), and the inner polarity is negative (-). This instrument is designed for use with the AC adapter AC-A412. Please do not use any other adapter with this instrument.
- ❗ Read through this manual before powering up this instrument for the first time.

## Connecting the AC Adapter

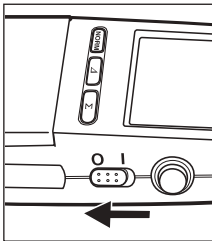

**1** Set the power switch to "O" (OFF).

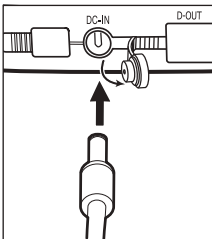

**2** Connect the AC adapter to the AC adapter terminal.

**3** Insert the AC adapter's cord plug to an AC outlet.

- When unplugging the AC adapter, always set the power switch to "O" (OFF) first.



# ***Advanced Operations***

---

# Color Correction Factor (CCF)

When measuring under a light source which has a considerably different spectral distribution from T-10A/T-10MA's calibration light source, the instrument will cause an indication error due to a slight deviation of the relative spectral response from spectral luminous efficiency ( $V_\lambda$ ). To correct this error, this instrument has CCF function (mode), allowing you to set the color correction factor (CCF). In addition to the purpose of color correction, the CCF function can also be used for correction of indication errors between multiple T-10/T-10A illuminance meters and for user calibration under an accurately set light source.

## Measurement using the CCF

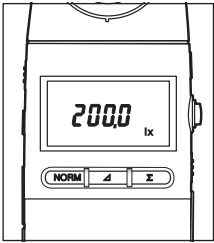

**1** Push out the hold button (RUN).

◆ Measurement will start.

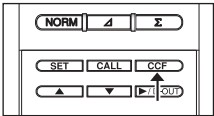

**2** Open the slide cover and press the [CCF] key.

- In CCF mode, the following value is displayed.

Displayed value = Measured value x Color correction factor (CCF)

Pressing the [CCF] key will cancel correction, and the measured value which has not been corrected will be displayed.

Example) When CCF = 0.900:



▲ Normal mode



▲ CCF mode

- Once the CCF is set, it will remain effective until it is changed.

# CCF Setting Method

The CCF can be set in the following two ways.

Once the CCF is set, it will remain effective even if the power is turned OFF or the batteries are changed.

## ① Entering the CCF directly

This method can be used if the CCF is known.

### ■ Entering the CCF

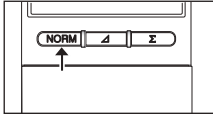

**1** Press the [NORM] key to activate normal mode.

- The CCF can be set in normal mode only.

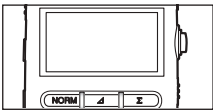

**2** Push out the hold button (RUN).

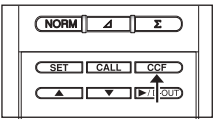

**3** Open the slide cover and press the [CCF] key.

- ◆ CCF mode will be activated.

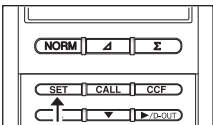

**4** Press the [SET] key.

- ◆ The instrument is now ready for you to enter a value, and the currently set CCF (default: 1.000) will blink.



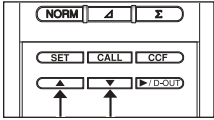

## 5 Change the CCF using the [▲] and [▼] keys.

- ◆ Each time the [▲] or [▼] key is pressed, the value will change in 0.001 steps (settable range: 0.500 to 2.000). Holding the [▲] or [▼] key will cause the displayed value to change continuously.
- To exit setting, press the [CALL] key.



## 6 When you have changed the value, press the [SET] key.

- ◆ The CCF will be set.

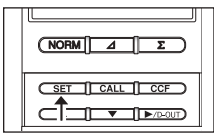

- To check the currently set CCF, press the [CALL] key. The currently set CCF will be displayed while the [CALL] key is held down.

## ② Entering the reference value

If you have a strictly controlled reference light source, the correction factor (CCF) can be obtained using the CCF function.

If the reference illuminance value of the target light source is known, just enter the reference value to the instrument. The CCF will be calculated and set automatically.

### ■ Entering the Reference Value

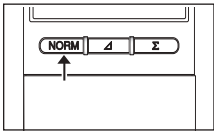

## 1 Press the [NORM] key to activate normal mode.

- The reference value can be set in normal mode only.

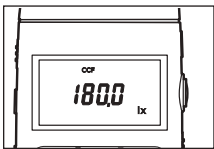

## 2 Push in the hold button (HOLD).

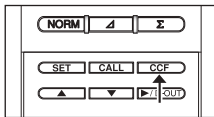

## 3 Open the slide cover and press the [CCF] key.

- ◆ CCF mode will be activated.





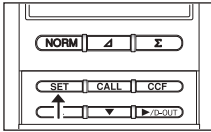

## 4 Press the [SET] key.

- ◆ The instrument is now ready for you to enter a value, and the currently displayed measured value will blink.



## 5 Enter the value using the [▲] and [▼] keys.

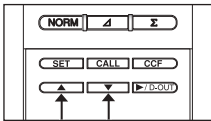

- ◆ Each time the [▲] or [▼] key is pressed, the value will change in steps of the smallest digit. Holding the [▲] or [▼] key will cause the displayed value to change continuously.
- To exit setting, press the [CALL] key.

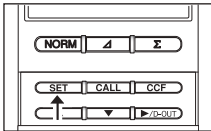

## 6 When you have entered the value, press the [SET] key.

- ◆ The CCF will be calculated from the entered reference value and then set.
- If the calculated correction factor is not within the range from 0.500 to 2.000, the display shows "Err A", and then returns to the beginning of the SET mode. Reenter the values.

- To check the currently set value, press the [CALL] key. The currently set value will be displayed while the [CALL] key is held down.

# Setting the Range Manually

The measuring range is switched automatically from one to another during measurement (5 ranges are available).

When you want to fix the range or you want to perform measurement of illuminance continuously using the analog output function (see page 28), set the measuring range as follows.

## Manual/auto measuring ranges

Range	Measuring range (unit: lx)		Measuring range (unit: fcd)	
	Manual	Auto	Manual	Auto
1	0.00 – 29.99	0.00 – 29.99	0.000 – 2.999	0.000 – 2.999
2	0.0 – 299.9	25.0 – 299.9	0.00 – 29.99	2.50 – 29.99
3	0 – 2999	250 – 2999	0.0 – 299.9	25.0 – 299.9
4	0 <sub>0</sub> – 2999 <sub>0</sub>	250 <sub>0</sub> – 2999 <sub>0</sub>	0 – 2999	250 – 2999
5	0 <sub>00</sub> – 2999 <sub>00</sub>	250 <sub>00</sub> – 2999 <sub>00</sub>	0 <sub>0</sub> – 2999 <sub>0</sub>	250 <sub>0</sub> – 2999 <sub>0</sub>

\* The above measuring ranges are effective only when CCF correction is not used.

\* It is possible to find the currently selected range by the position of the displayed decimal point, “0” or “00”.

## Setting Method

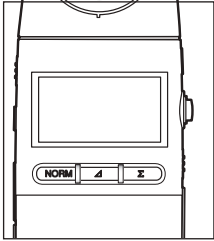

**1** Have the instrument ready for operation as described in “Measuring the illuminance” (page 13) and push out the hold button (RUN).

- The range can be switched in RUN state only.

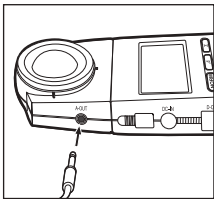

**2** Insert the Mini plug (optional) into the analog output terminal. “MANU.” will appear in the display section.

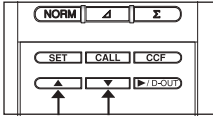

### 3 Open the slide cover and select the desired range using the [▲] and [▼] keys.

- ◆ The range will be set immediately when it is selected.
- Each time the [▲] or [▼] key is pressed, the range switches from one to another in the following order and the maximum value for the selected range is displayed.

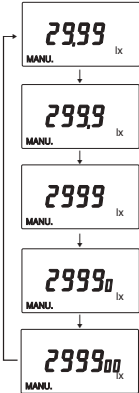

\* In the above example, the [▲] key is pressed to change the display. The display will change in opposite direction if the [▼] key is pressed.

- If the power switch is set to "I" (ON) with the mini plug inserted into the analog output terminal, the "0 to 2.999 lx" range will be selected automatically.
- If the mini plug is inserted while measurement is in progress in AUTO range mode, the range used in AUTO range mode will remain effective.
- Once a range is selected manually, it will remain unchanged even if the power switch is switched from "O" (OFF) to "I" (ON).
- If CCF mode is set, the measuring range that does not cause the color correction factor (CCF) to affect the measured value will be selected in the case of MAN range mode.

### Over-range Error

If the measured illuminance exceeds the range during MAN range mode, "-0-" will blink to inform that an over-range error has occurred.



# Recording the Measured Illuminance Continuously (Analog Output)

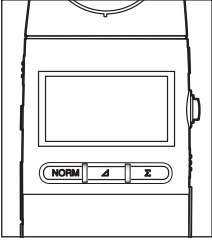

**1** Have the instrument ready for operation as described in “Measuring the illuminance” (page 13) and push out the hold button (RUN).

- The range can be switched in RUN state only.

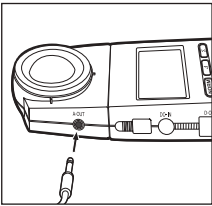

**2** Insert the Mini plug (optional) into the analog output terminal.

- How to connect the Mini plug (optional)  
When connecting the instrument to an external device, solder the Mini plug as shown in the figure. Be sure to connect a shielded cable to the Mini plug.

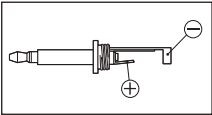

**3** Select the measuring range suitable for the illuminance to be measured.

- Refer to “Setting the Range Manually” (page 32).

**4** Adjust the sensitivity of the recorder according to the illuminance to be measured.

- The analog output level of this instrument is 1 mV/digit (one display count), and the maximum output voltage is 3 V (3,000 mV).

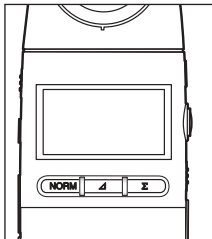

**5** Attach the cap to the receptor head (or block the head to prevent entry of external light).

- ◆ “0 lx” will appear in the display section. However, the analog output voltage may not be 0 mV due to the offset voltage.

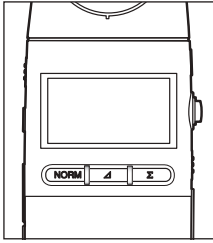

**6** Adjust the zero level of the recorder so that the analog output voltage from the instrument equals to the zero level of the recorder.

**7** Remove the cap (or block).

◆ An analog signal (i.e. voltage) proportional to the measured illuminance will be output, and the measured illuminance will be recorded continuously to the recorder.

- A voltage corresponding to the displayed significant digits (0 to 3,000 mV) will be output, irrespective of the currently selected range. The range corresponding to the output voltage is displayed in the display section.
- In CCF mode, a signal corresponding to the measured value will be output, irrespective of the CCF.
- The recorder to be connected to the analog output terminal must have an input impedance of 1 MΩ or higher. Since the output impedance of this instrument is 10 kΩ, the indication error will be 1% or less if the input impedance of the recorder is 1 MΩ or higher.
- The measured illuminance is always output from the analog output terminal, irrespective of what is displayed. Thus, it is possible to display the illuminance difference/ratio or integrated illuminance or hold the displayed value even if recording is in progress.
- To observe the waveform of a flicker light with an oscilloscope, select the range that does not cause the peak value of the flicker light to exceed 3,000 mV.

▼ Measuring ranges and analog outputs by manually selected ranges when analog output terminal is used

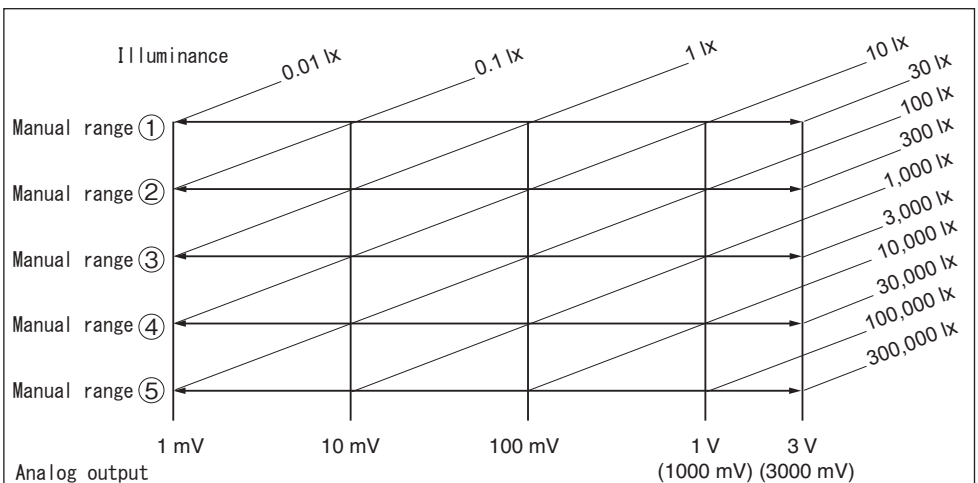

# Printing the Measured Data (Digital Output)

## Digital Output of the Measured Value

This section explains how to print out the measured data.

To print out the data, the printer cable T-A12 (optional) is required to connect a printer to the instrument.

## Printer Requirements

The printer must meet the following requirements.

Number of print digits	: 27 or more
Data input	: RS-232C
Data control	: Busy
Baud rate	: 9,600
Character length	: 7 bits
Parity	: Even
Stop bit	: 1 bit
Basic function	: CR (0DH) carriage return

## Example of recommended printer

Model name: DPU-H245AS-A03A (Seiko Instruments Inc.)

## Procedure

Connect the instrument to the printer with the printer cable T-A12.

- Before connecting them, make sure that the instrument's power switch is set to "O" (OFF).
- Always set the instrument's power switch to "I" (ON) before turning ON the printer's power switch. If the printer's power switch is turned ON first, the printer may not work properly.

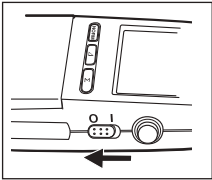

**1** Make sure that the instrument's power switch is set to "O" (OFF), and connect the instrument to the printer with the printer cable TA12.

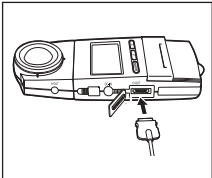

- The illustration on the left shows an example of connecting the instrument to the printer.

▼ Connection to the printer

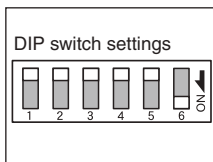
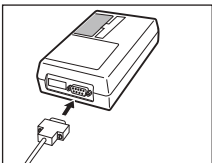

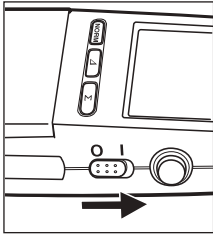

**2** Set the instrument's power switch to "1" (ON), then turn ON the printer.

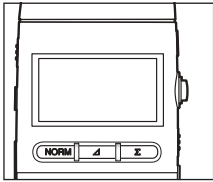

**3** Push out the hold button (RUN), and start measurement.

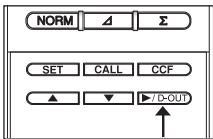

**4** Press the [▶/D-OUT] key.

- ◆ Each time the key is pressed, the data effective when the key is pressed will be sent to the printer and printed out.
- If you want to hold the data, push in the hold button (HOLD), then press the [▶/D-OUT] key.

- While the printer cable T-A12 is connected to the instrument, consumption current will be approximately 1.5 times as much as when it is disconnected.
- If you are not going to use the printer, make sure that the printer cable is disconnected.

## Print example

1013 lx	}	NORM: Displays illuminance (lx).
1017 lx		
DLT + 291 lx	}	Δ: Displays illuminance difference (lx).
DLT + 306 lx		
DLT - 25.3 lx		
DLT 155.0 %	}	Δ: Displays illuminance ratio (%).
DLT 79.6 %		
0.033 h	}	Σ: Displays integrated illuminance (lx·h).
21.53 lx·h		
0.037 h	}	Σ: Displays integration time (h).
24.21 lx·h		
0.044 h	}	Σ: Displays average illuminance (lx).
28.98 lx·h		
0.047 h	}	Σ: Displays average illuminance (lx).
31.09 lx·h		
0.049 h	}	Σ: Displays average illuminance (lx).
668.9 lx AVE		
0.050 h	}	Σ: Displays average illuminance (lx).
678.1 lx AVE		

NORM: Displays illuminance (lx).

Δ: Displays illuminance difference (lx).

Δ: Displays illuminance ratio (%).

Σ: Displays integrated illuminance (lx·h).

Σ: Displays integration time (h).

(The print contents are the same as when integrated illuminance is measured.)

Σ: Displays average illuminance (lx).

# Connecting to a PC

You can connect the CHROMA METER to a personal computer using the (optional) T-A15 USB cable. You can then transfer the measurement data to the computer, and use the computer to store and manage the data.

If you install KONICA MINOLTA's standard T-S10w data management software on your computer, you will also be able to use the computer to view measurement results in real time and to control multi-point measurements. The software also makes it possible to use CF correction with MULTI calibration mode, a feature that is not available on the CHROMA METER alone. For information about how to use the T-S10w software, read the INSTRUCTION MANUAL.

If you want to use an independent program on PC to control this instrument, download Communication Specifications from KONICA MINOLTA's website at URL below for your reference

<https://www.konicaminolta.com/instruments/download/software/light/index.html>

(The above URL is subject to change without notice.)

(If the target page will not appear, please search the site by keywords, T-10 and download.)

- Printing is not allowed as long as USB cable T-A15 is plugged to the instrument.
- Connection of the T-A15 USB cable increases the CHROMA METER's consumed current by about 50%. When you have finished using the computer connection, please disconnect the USB cable.
- Be sure to use the USB cable specified in this manual. Using other USB cables than specified may cause communication errors or noises.



# Separating the Receptor Head from the Main Body

By using the optional adapters T-A20 (for main body) and T-A21 (for receptor head), the receptor head can be separated from the main body for measurement.

## Items Required

- Main body adapter  
(with an extension cable) : T-A20 (optional)
- Receptor head adapter : T-A21 (optional)

If the cable supplied with the adapter is not long enough:

- Use a commercially available 10Base-T network cable (category 5 straight cable). The cable can be extended up to 100 meters. Using a cross cable will disable the instrument and may cause malfunction of the connected system.

## Measuring Method

- If measurement is performed with the receptor head connected to the main body with the extension cable, the measured values and operation of the instrument may be affected if equipment which generates electrical noise is present near the extension cable. In this case, such equipment must be kept away from the cable during measurement.

**1** Set the power switch to “O” (OFF).

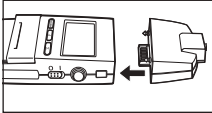

**2** Attach the main body adapter to the instrument.

- The receptor of T-10A or mini receptor of T-10MA is not compatible with existing model T-10 or T-10M.

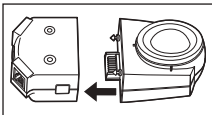

▼For T-10MA

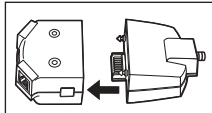

**3** Attach the receptor head adapter to the receptor head (mini receptor head in the case of T-10MA).

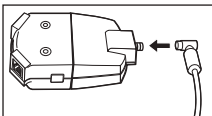

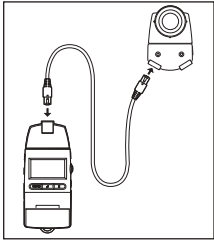

**4** Connect both adapters with the extension cable.

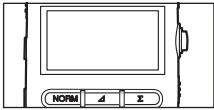

**5** Set the power switch to “I” (ON) and push out the hold button (RUN).

◆ Measurement will start.

- If the receptor head is connected to the main body through the extension cable and measurement is performed, consumption current will increase by approximately twice.

## Fixing the Receptor Head

The receptor head can be fixed in the measuring location (e.g. on a panel) by the following methods. (For the reference measurement plane, refer to page 51.)

- ① By using the tripod fixing screw hole on the back of the receptor head
- ② By using the holes on the receptor head adapter (T-A21)

### Dimensions

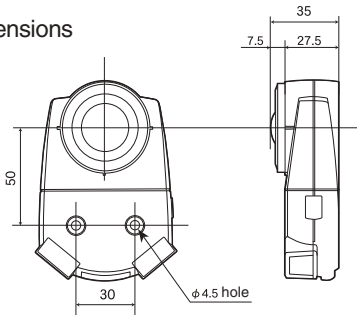

An example of affixing the head to a panel

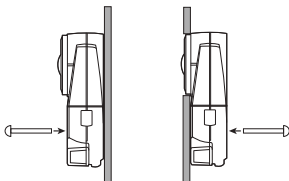

# Multi-Point Measurement

This instrument allows you to perform multi-point measurement by using more than two optional receptor heads and adapters. (Up to 30 receptor heads and adapters can be connected.) Since each receptor head must be powered constantly during multi-point measurement, the optional AC adapter must be used.

## Items Required

- Main body adapter  
(with an extension cable) : T-A20 (optional)
- Receptor head adapter : T-A21 (optional)
- AC adapter : AC-A412 (optional)

If the cable supplied with the adapter is not long enough:

- Use a commercially available 10Base-T network cable (category 5 straight cable). The cable can be extended up to 50 meters. Using a cross cable will disable the instrument and may cause malfunction of the connected system.

## Measuring Method

- If measurement is performed with the receptor head connected to the main body with the extension cable, the measured values and operation of the instrument may be affected if equipment which generates electrical noise is present near the extension cable. In this case, such equipment must be kept away from the cable during measurement.

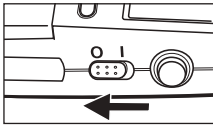

- 1 Set the power switch to “O” (OFF), and attach the AC adapter to the instrument.**

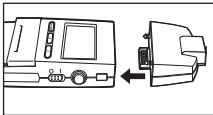
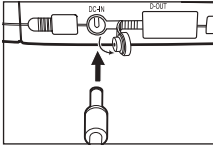

- 2 Attach the main body adapter to the instrument.**

- The receptor of T-10A or mini receptor of T-10MA is not compatible with existing model T-10 or T-10M.

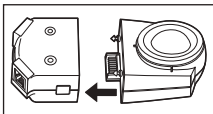

▼For T-10MA

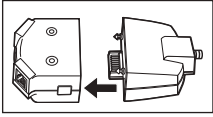

**3** Attach a receptor head adapter to each receptor head (mini receptor head in the case of T-10MA).

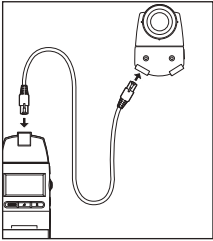
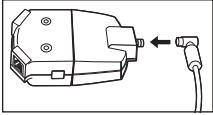

**4** Connect both adapters an extension cable.

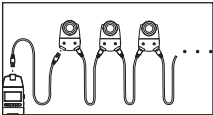

**5** Connect the remaining receptor heads serially with extension cables.

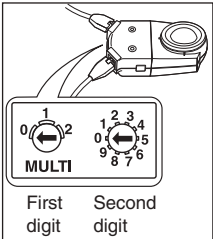

**6** Set an ID no. to each receptor head using the rotary switch of the adapters.

- ID nos. can be between 00 and 29.
- Make sure that ID nos. are unique.

- The ID nos. will be read to the main body when the power switch is set to “I” (ON). To set or change them, make sure to set the power switch to “O” (OFF) first. If an ID no. is changed during measurement, it will not be acknowledged by the main body.

Print the ID nos. on labels using a label writer and affix them on the corresponding receptor head adapters. This will help you find the ID nos. easily.

▼An example of affixing a label “09” (ID no.) on the corresponding receptor head adapter

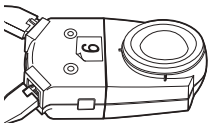



## 7 Set the power switch to "I" (ON).

- ◆ The smallest ID no. among those currently set will be displayed at the upper right of the display section.
- Press the [▲] or [▼] keys to check that the ID no. switches from one to another. Make sure that the ID nos. of all the connected receptor heads are displayed one at a time (they are displayed in the ascending order: starting from the smallest ID no.).
- If they are not displayed, check connection between the main body and receptor heads as well as the ID nos.

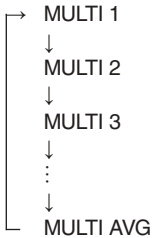

Average value of those measured by all the connected receptor heads

\* In the above example, the [▲] key is pressed to change the display. The display will change in opposite direction if the [▼] key is pressed.



## 8 Push out the hold button (RUN).

- ◆ Measurement will start, and the value measured by one of the receptor heads or the average value of those measured by the connected receptor heads will be displayed.
- Measured values are displayed in the order of ID nos.
- Each time the [▲] or [▼] key is pressed, the measured value will switch from one receptor head to another.

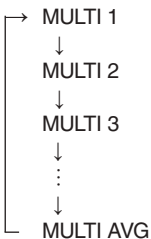

Average value of those measured by all the connected receptor heads

\* In the above example, the [▲] key is pressed to change the display. The display will change in opposite direction if the [▼] key is pressed.

\* If a large number of receptor heads are connected, the display will not switch from MULTI AVG immediately even if the [▲] (or [▼]) key is pressed. In this case, keep holding down the [▲] (or [▼]) key.

# Notes on Multi-Point Measurement

## Receptor Head ID No.

- Be sure to set unique ID numbers for all heads. If you set the same number on more than one head, the ILLUMINANCE METER will fail recognizing the heads, resulting in measurement errors.

## Illuminance Difference/Ratio Measurement

- The reference value must be set for each receptor head.
- Measured value will be displayed individually for each receptor head.

## Integrated Illuminance Measurement

- Illuminance measurement setting must be made for each receptor head.
- Measured value will be displayed individually for each receptor head.

## Automatic Integration Stop Function

- Integration time/integrated illuminance must be set for each receptor head.
- When integration is paused, the unit (lx·h, lx, h) will blink individually for each receptor head.

## Color Correction Factor (CCF)

- The color correction factor must be set for each receptor head, and whether or not to operate the instrument in CCF mode (i.e. whether or not to apply the factor) must also be set for the receptor head.
- In CCF mode, the value which has been corrected by the CCF will always be displayed, irrespective of measurement mode (illuminance difference/ratio, integrated illuminance, automatic integration stop and MULTI AVG display).

## About Printing

- When [▼/D-OUT] is pressed, the readout on the display of the currently selected head is sent to the printer. You can print out data for other heads by changing the head selection.

## Manual Range Setting

Before setting the measuring range for multi-point measurement, the optional mini plug must be connected to the analog output terminal of the receptor head. The following points differ from when only one receptor head is connected.

- The range which was in effect when the mini plug was connected will be selected.
- It is not possible to change the range since the [▲] or [▼] keys are used to switch the receptor head from one to another.
- If you want to change the range, insert the mini plug while measurement is performed with the desired range. (For the auto/manual measuring range, refer to page 32.)

## MULTI AVG Display

- If an error (range-over error, communication error etc.) occurs with any of the connected receptor heads, no data will be displayed during measurement.
- No measured values will be displayed in illuminance difference/ratio, integrated illuminance and automatic integration stop modes.
- The CCF mark will not displayed even if the color correction factor (CCF) is valid.

## About Extension Cable

- Be sure to use a category 5 straight cable when extending the receptor cable length or performing multi-point measurement.  
Using a cross cable will disable the instrument and may cause malfunction of the connected system.

# ***Accessories***

---

## Standard Accessories

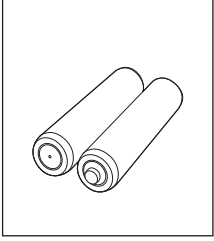

**Batteries**

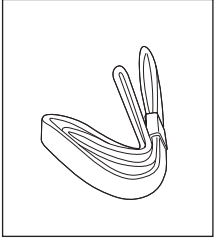

**Strap**

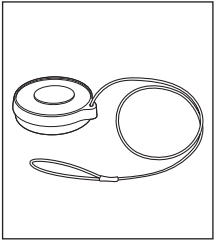

**Cap T-A13  
(for T-10 only)**

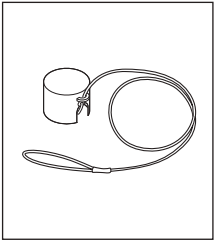

**Mini Cap T-A14  
(for T-10M only)**

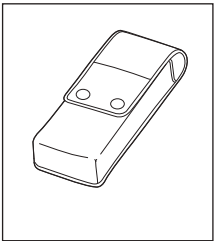

**Case T-A10**

## Optional Accessories

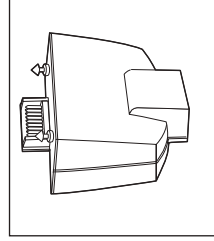

**Main body  
adapter T-A20**

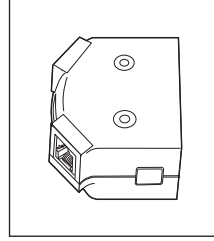

**Receptor head  
adapter  
T-A21**  
● With an extension  
cable (1 m)

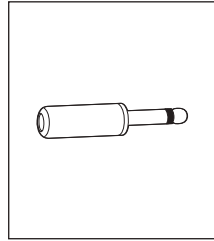

**Mini plug**

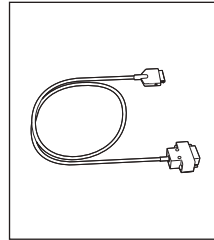

**Connecting cable  
T-A11 (for personal  
computer)  
T-A12 (for printer)**

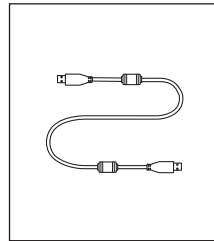

**USB Cable  
T-A15**



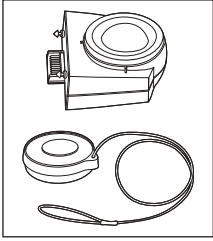

### T-10A receptor head

- With a cap

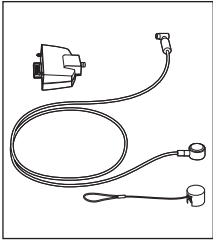

### T-10MA receptor head (mini type)

- With a mini cap

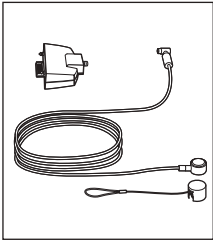

### T-10W<sub>s</sub>A receptor head (water-proof mini type: 5 m)

- With a mini cap

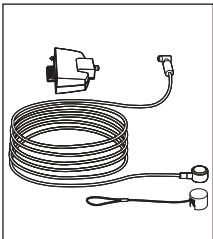

### T-10W<sub>L</sub>A receptor head (water-proof mini type: 10 m)

- With a mini cap

\* Custom order

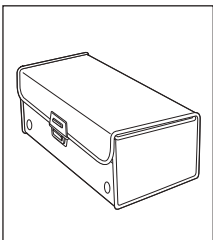

### Hard Case CL-A10

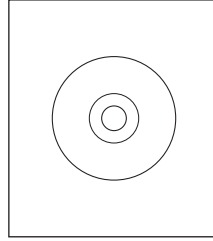

### Data Management Software T-S10w

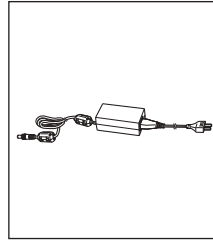

### AC Adapter AC-A412

(ATS036T-A120)

Input :

100-240 V ~

50-60 Hz 1 A MAX

Output :

12 V  3 A

plug design 

Center-negative



# System Diagram

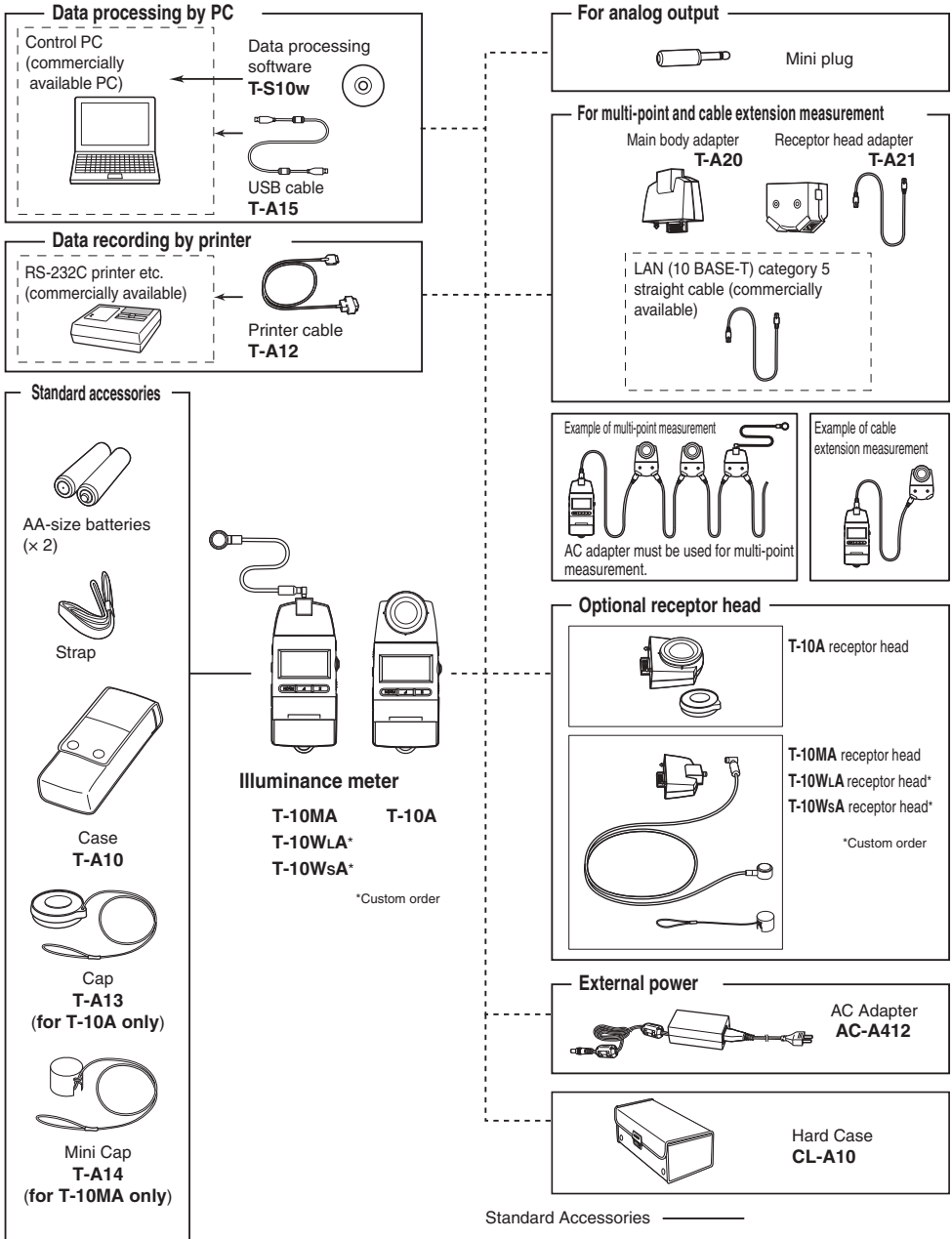

# ***Explanation***

---

## Error Messages

An error may occur during operation due to some problems. If an error occurs, refer to the table below and take the necessary action.

Message	Description	Action
E r r U E r r E	Initial communication error No response from the receptor head during initial communication	Check connection. If the instrument is connected properly, contact the nearest Konica Minolta-authorized service facility.
	Start command error The receptor head has not received the start command, because, for instance, the receptor head was not connected to the main body at the time the power was turned ON.	Set the power switch to “I” (ON) again. If this message reappears, contact the nearest Konica Minolta-authorized service facility.
E r r	EEPROM error Error with the EEPROM data (in the receptor head)	Remove the batteries (or AC adapter), then re-install them. If this message reappears, contact the nearest Konica Minolta-authorized service facility.
E r r A	Preset value error The value is outside the settable range.	Check the settable range, and make sure that the value is inside the range.
E r r C	Communication error (main body ↔ receptor head) Communication between the main body and receptor head was not performed properly.	Check connection. If the instrument is connected properly, contact the nearest Konica Minolta-authorized service facility.

# Reference Measurement Plane / Dimension Diagram

(Unit: mm)

The top of the receptor window is used as the reference plane for measurement as shown below.

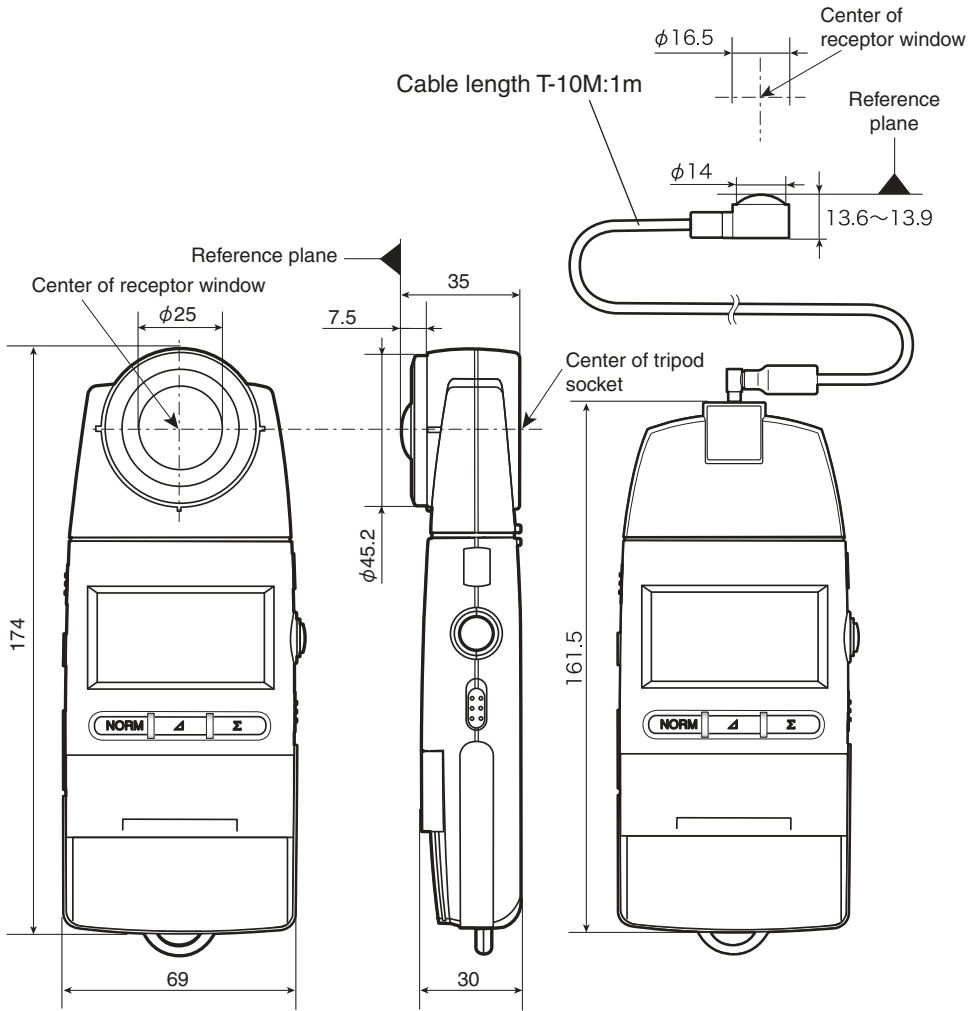

T-10A

T-10MA

# Relative Spectral Response

## [Conforms to JIS]

Ideally, the relative spectral responsivity of the illuminance meter should match  $V(\lambda)$  the spectral luminous efficiency of the human eye for photopic vision.

As shown in the graph above, the relative spectral responsivity of Konica Minolta Illuminance Meters T-10A/T-10MA is within 6% ( $f_1'$ ) of the JIS spectral luminous efficiency  $V(\lambda)$ .

Class	General class Precise	General class AA	General class A
$f_1'$ (%)	3	6	9

JIS ; Japanese Industrial Standards

$f_1'$  (JIS's symbol) ; The degree to which the relative spectral responsivity matches  $V(\lambda)$  is characterized by means of the error  $f_1'$ .

$$f_1' = \frac{\int_{\lambda_1}^{\lambda_2} |S'(\lambda)_{rel} - V(\lambda)| d\lambda}{\int_{\lambda_1}^{\lambda_2} V(\lambda) d\lambda} \times 100(\%)$$

Note : The constant has the dimension  $nm^{-1}$

$S'(\lambda)_{rel}$  normalized relative spectral responsivity

$$S'(\lambda)_{rel} = \frac{\int_{\lambda_1}^{\lambda_2} P(\lambda)_A V(\lambda) d\lambda}{\int_{\lambda_1}^{\lambda_2} P(\lambda)_A S(\lambda)_{rel} d\lambda} \cdot S(\lambda)_{rel}$$

$P(\lambda)_A$  Spectral distribution of the illuminant used in the calibration (standard illuminant A)

$S(\lambda)_{rel}$  Relative spectral responsivity with arbitrary reference

$V(\lambda)$  Spectral luminous efficiency of the human eye for photopic vision

$d\lambda$  Wavelength pitch

$\lambda_1$  Lower limit of visible wavelength region

$\lambda_2$  Upper limit of visible wavelength region

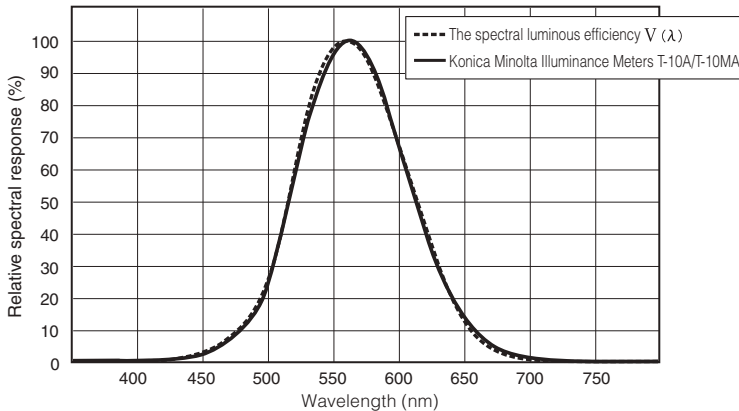

## [Conforms to DIN]

Ideally, the relative spectral responsivity of the illuminance meter should match  $V(\lambda)$  the spectral luminous efficiency of the human eye for photopic vision.

As shown in the graph above, the relative spectral responsivity of Konica Minolta Illuminance Meters T-10A/T-10MA is within 6% ( $f_1$ ) of the DIN spectral luminous efficiency  $V(\lambda)$ .

Class	L	A	B	C
$f_1$ (%)	1.5	3	6	9

DIN ; Deutsche Industrie Normen

$f_1$  (DIN's symbol) ; The degree to which the relative spectral responsivity matches  $V(\lambda)$  is characterized by means of the error  $f_1$ .

$$f_1 = \frac{\int_0^{100} |S_{rel}^*(\lambda) - V(\lambda)| d\lambda}{\int_0^{100} V(\lambda) d\lambda} \times 100(\%)$$

Note : The constant has the dimension  $\text{nm}^{-1}$

$$S_{rel}^*(\lambda) = \frac{\int_0^{100} S_A(\lambda) V(\lambda) d\lambda}{\int_0^{100} S_A(\lambda) S_{rel}(\lambda) d\lambda} \cdot S_{rel}(\lambda)$$

- $S_{rel}^*(\lambda)$  Normalized relative spectral responsivity
- $S_A(\lambda)$  Spectral distribution of the illuminant used in the calibration
- $S_{rel}(\lambda)$  Relative spectral responsivity with arbitrary reference
- $V(\lambda)$  Spectral luminous efficiency of the human eye for photopic vision

# Cosine Correction Characteristics

## [Conforms to JIS]

Since the brightness at the measurement plane is proportional to the cosine of the angle at which the light is incident, the response of the receptor must also be proportional to the cosine of the incidence angle. The graph above shows the cosine correction characteristics of Konica Minolta Illuminance Meters T-10. The cosine error of T-10 are shown in the table right.

Class	General class Precise	General class AA	General class A
f <sub>2</sub> (%)	1.5	3	6

f<sub>2</sub> can be calculated as follows.

$$f_2 = \int_0^{\frac{80^\circ \pi}{180^\circ}} |f_2^*(\theta)| \sin 2\theta d\theta$$

In addition, f<sub>2</sub>\* (θ) is represented by the following equation.

$$f_2^*(\theta) = \left| \frac{Y(\theta)}{Y_0 \cos \theta} - 1 \right| \times 100 \text{ (%)}$$

Y<sub>0</sub> : Vertical illuminance values  
Y (θ) : Illuminance values in the incident angle (θ)

The following shows the angle deviation from cosine characteristics in terms of the incident angle of the light for reference.

Oblique incident angle	General class Precise	General class AA	General class A
10°	± 1%	± 1%	± 1.5%
20°	± 1.5%	—	—
30°	± 2%	± 2%	± 3%
40°	± 3%	—	—
50°	± 4%	± 6%	—
60°	± 5%	± 7%	± 10%
70°	± 8%	—	—
80°	± 20%	± 25%	± 30%

The instrument has the following optical characteristics of the oblique incident lights denoting that this is an illuminance meter conforming to JIS general class AA (f<sub>2</sub>=3% max.).

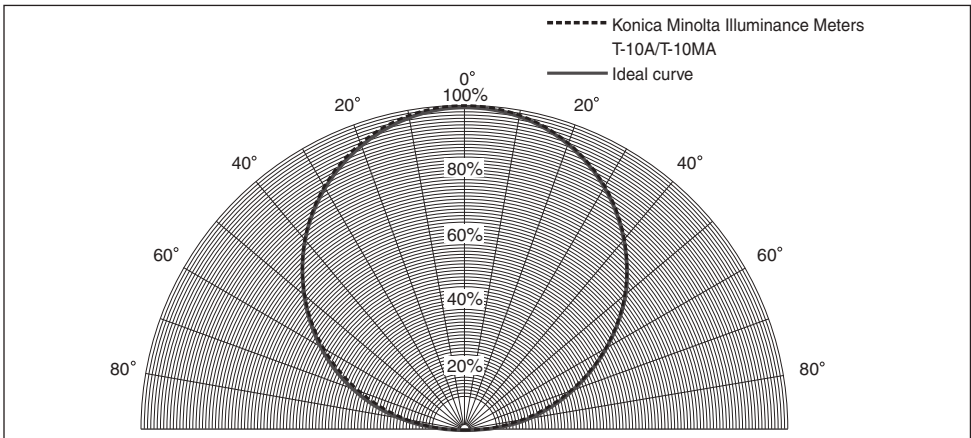



## [Conforms to DIN]

Since the brightness at the measurement plane is proportional to the cosine of the angle at which the light is incident, the response of the receptor must also be proportional to the cosine of the incidence angle. The graph above shows the cosine correction characteristics of Konica Minolta Illuminance Meters T-10. The cosine error of T-10 are shown in the table right.

Class	L	A	B	C
$f_2$ (%)	1.5	1.5	3	6

$f_2$  can be calculated as follows.

$$f_2 = \int_0^{\frac{85^\circ \pi}{180}} |f_2(\theta)| \sin 2\theta d\theta$$

In addition,  $f_2(\theta)$  is represented by the following equation.

$$f_2(\theta) = \left| \frac{Y(\theta)}{Y(0) \cos \theta} - 1 \right| \times 100 \text{ (\%)}$$

$Y(\theta)$  : Signal output as a function of the angle of incidence

$\theta$  : Azimuth angle measured with respect to the normal to the measuring plane or optical axis

# Specifications

Model		Illuminance Meter T-10A (Standard receptor head)	Illuminance Meter T-10MA (Mini receptor head)
Type	Multi-function digital illuminance meter with detachable receptor head (Multi-point measurements of 2 to 30 points is possible)		
Illuminance meter class	Conforms to requirements for Class AA of JIS C 1609-1: 2006 "Illuminance meters Part 1: General measuring instruments" Conforms to DIN 5032 Part 7 Class B		
Receptor	Silicon photocell		
Relative spectral responsivity	Within 6% (f <sub>1</sub> ') of the CIE spectral luminous efficiency V (λ)		
Cosine correction characteristics (f <sub>2</sub> )	Within 3%		
Measuring range	Auto range (5 manual ranges at the time of analog output)		
Measuring function	Illuminance (lx), illuminance difference (lx), illuminance ratio (%), integrated illuminance (lx·h), integration time (h), average illuminance (lx).		
Measuring range	Illuminance	0.01 to 299,900 lx; 0.001 to 29,990 fcd	
	Integrated illuminance	0.01 to 999,900 x 10 <sup>3</sup> lx·h 0.001 to 99,990 x 10 <sup>3</sup> fcd·h / 0.001 to 9999 h	
User calibration function	CCF (Color Correction Factor) setting function: Measurement value x 0.500 to 2.000		
Linearity	±2% ±1 digit of displayed value		
Temperature drift	Within ±3%		
humidity drift	Within ±3%		
Measurement speed	2 times/sec. (continuous measurement with 1 receptor head)		
Computer interface	USB		
Printer output	RS-232C		
Analog output	1 mV/digit, 3 V at maximum reading; Output impedance: 10 KΩ; 90% response time: 28 ms		
Display	3 or 4 Significant-digit LCD with backlight illumination (Automatic illumination)		
Power	2 AA-size batteries / AC adapter AC-A412 (optional; for 1 to 30 receptors)		
Battery performance	72 hours or longer (when alkaline batteries are used) in continuous measurement		
Operation temperature /humidity range	-10 to 40°C, relative humidity 85% or less (at 35°C) with no condensation		
Storage temperature / humidity range	-20 to 55°C, relative humidity 85% or less (at 35°C) with no condensation		
Size (W x D x H)	69 x 174 x 35 mm	Main body: 69 x 161.5 x 30 mm Receptor: ø16.5 x 13.8 mm	
Cord length	–	1 m	
Weight (without battery)	200 g (7.0 oz.)	205 g	

● Specifications are subject to change without notice.

**[CAUTION]**

KONICA MINOLTA WILL NOT BE LIABLE FOR ANY DAMAGES RESULTING FROM THE MISUSE, MISHANDLING, UNAUTHORIZED MODIFICATION, ETC. OF THIS PRODUCT, OR FOR ANY INDIRECT OR INCIDENTAL DAMAGES (INCLUDING BUT NOT LIMITED TO LOSS OF BUSINESS PROFITS, INTERRUPTION OF BUSINESS, ETC.) DUE TO THE USE OF OR INABILITY TO USE THIS PRODUCT.



KONICA MINOLTA